

GERMAN
POOL



德國寶

抽濕機
DEHUMIDIFIER

GP-216RC
GP-218RC

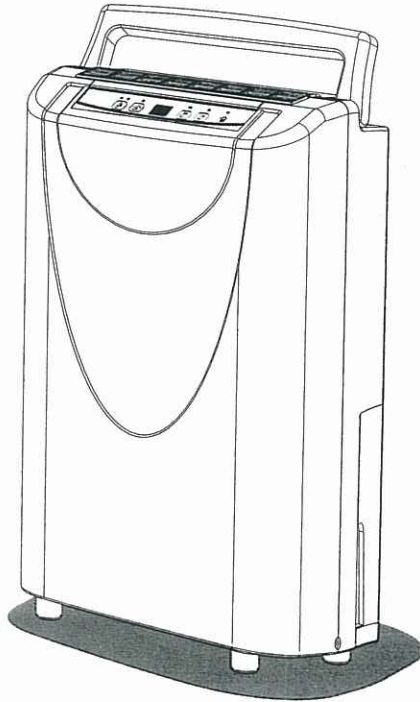

在使用之前請詳細閱讀「使用說明書」及「保用條例」，並妥為保存。
Please read these instructions and warranty information carefully before use and keep them handy for future reference.



使用說明書 OPERATING INSTRUCTIONS

目錄

●安全使用注意事項	1
●外觀各部名稱說明	2
●使用方法	3-4
●使用注意事項	5-7
●故障排除	8
●規格	9



維修服務須使用原廠零件，如任意更換非本公司之原廠零件，致成本機及周遭財物等損害，本公司不負保固維修及一切損害之責任。

緊急處理方法

- 當本機有異常現象發生時，請盡速關閉電源開關，拔掉電源插頭，並請送至本公司的維修及客戶服務部處理，切勿自行拆修，以免發生危險。

安全使用注意事項

1. 使用前，請先確認電源電壓/頻率為220V/50Hz。
 2. 切勿以電線插頭的插入及拔出來控制機體之運轉及停止。
 3. 機體要移動位置時，請先關閉開關掣，然後再拔出電源線。
 4. 不要用棒狀物插進入風口及出風口內部。
 5. 請將機體水平地放置，切勿放置在不平或傾斜的地面上。
 6. 不要用水去噴灑機體。
 7. 機體上請勿噴灑殺蟲劑及可燃性液體。
 8. 機體上不可放置重物或讓小孩子乘坐、玩耍。
 9. 不得操作於密閉及狹窄的空間。
 10. 切勿覆蓋著出風口。
 11. 若電源線有損壞，必須由總代理的維修及客戶服務部人員更換，以免發生危險。
- 關於接地線之安裝
為防止意外觸電，務必裝好接地線。絕對不可利用瓦斯或自來水管來接地線。

外觀各部名稱說明

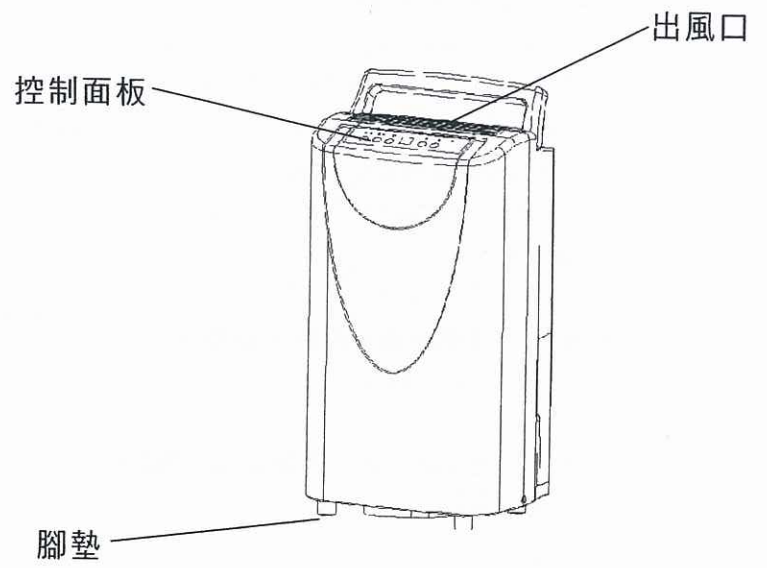

(圖一)

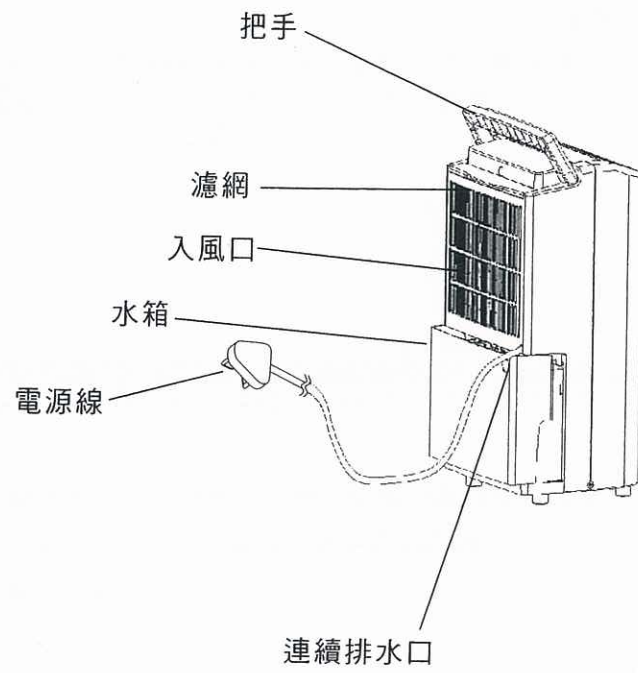

(圖二)

使用方法

● 操作面板圖示

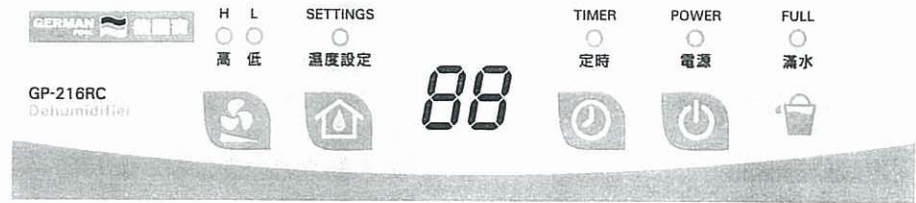

● 機體操作說明

1. 插上電源，電源指示燈會亮，蜂鳴器會發出嗶一聲，顯示窗會顯示室內濕度。

2.  電源按鍵
按此鍵，機體便開始運轉。機體初始濕度設定為60%，再次按下此鍵，機體便停止運轉。

3.  定時按鍵
a. 按此鍵來預設機體運轉時間。
b. 時間最長可設定24小時。
c. 如取消定時設定，只需按此鍵，設定為88便可。

4.  濕度設定按鍵
按此鍵設定室內濕度，可按下述順序設定:60%，65%，70%，75%，80%，40%，45%，50%，55%，60%。當室內濕度低於所設定的濕度時，機體會自動停機。

5.  風速設定按鍵 (H/L)
a. 按此鍵設定風速，可選擇高風速或低風速。
b. 剛開機時，機體原始設定為低風速。

注意事項：

1. 如設定濕度高於實際濕度，抽濕機將不運轉。
2. 水滿燈亮著時，本機會自動停止運轉。請將水箱內之水倒掉，並裝回水箱，機體會再次啟動、運轉。
3. 本機停機後，請等待五分鐘後再開機，以保障壓縮機的使用壽命。
4. 如長時間不使用抽濕機時，請拔掉電源線插頭。

● 性能特點說明

1. 自動抽濕
設定要求之濕度後，可全自動控制機體之運轉和停止，並維持濕度在設定的水平，方便又省電。
2. 可調式濕度控制設計
室內濕度控制於RH60%~50%之間。
3. 定時開關
預設開機時間。
4. 卡式濾網設計
 - A. 方便濾網之清洗，保障機體正常運作。
 - b. 將濾網往上拉即可取出。

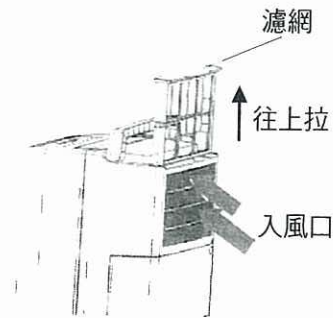

● 排水說明

(一) 水箱滿水時

1. 機體會停止運轉，滿水指示燈會亮著(紅色)。
2. 將水箱輕輕取出將水倒出
(由水箱兩側之凹槽拉出水箱)。
3. 完成後，將水箱輕輕推入機體，直至定位。

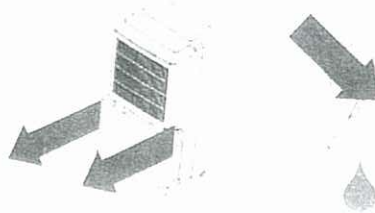

《注意事項》

* 為避免壓縮機因斷續起動而造成故障，請勿重覆“取出”、“放回”水箱之動作。

(二) 連續排水時

(使用排水管做連續排水)

1. 將水箱取出。
2. 將水箱之排水通孔用尖物打開，如圖標示A處。
3. 由排水通孔插入內徑 ϕ 9mmPVC排水管，並連接到機體之排水口，如下圖標示B處。
4. 檢查並確定排水管是緊接著排水口。
5. 再將水箱放回原位。

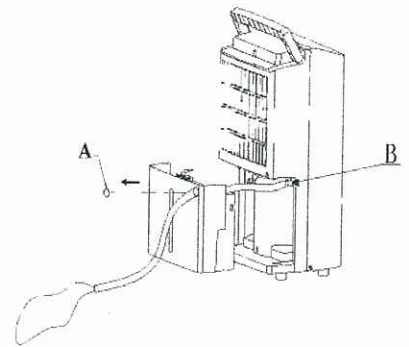

使用注意事項

- 1.本機適用溫度範圍為5°C-35°C，請在此範圍內使用(在此範圍外使用，機體會自動啟動開關保護裝置，使機體自動停止運轉，此為正常現象)。
- 2.室溫在5°C以下時，環境的絕對濕度相當低，基本上可以不必使用抽濕機。
- 3.機體運轉時，會啟動內部壓縮機，並產生熱量，故室溫會稍微上升，此為正常現象，請安心使用。
- 4.達到預設濕度時，機體會停止運轉。當室內濕度回升並高於預設濕度時，機體會重新運轉。
- 5.當水箱滿水時，機體會自動停止運轉。
- 6.為確保水箱內浮標之動作正常，請勿在浮標內設置任何東西。
- 7.機體無法啟動或因不明原因停止運轉時，請依下列步驟查驗：
 - (1)檢查插頭或電源是否正常。
 - (2)若上述正常，則等待5分鐘後再開機。
 - (3)若仍無法啟動，請與本公司的維修及客戶服務部聯絡。
- 8.入風口和出風口要與週邊物件保持20公分距離以上。

● 清潔保養說明



使用時，請勿將機體置於柔軟、不平地面上，以避免產生震動或移動。

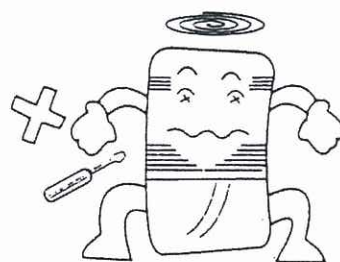

不可使用細棒、硬物插入機體內，以免發生故障或危險。

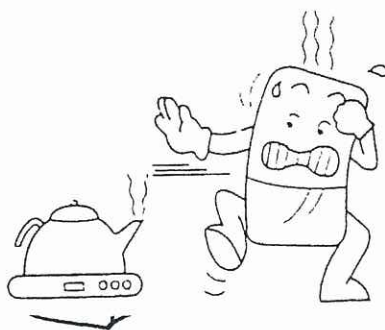

使用時，請將機體遠離暖爐、電熱水壺等熱源，可節省用電。



使用時，請關閉門窗，以達到最佳的抽濕效果。

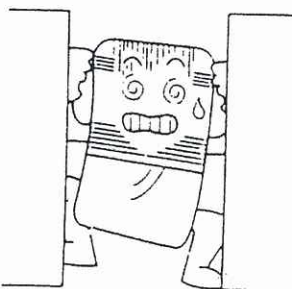

請勿擺放物品在機體前後。通風受阻，會影響抽濕效果。



如遇停電或長期不使用時，請拔掉電源線插頭。

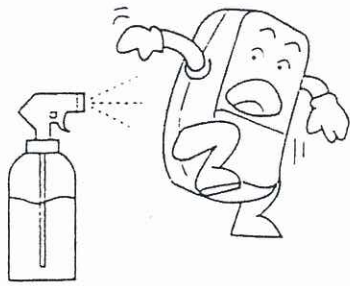

清理機體時，以濕布輕輕擦拭即可，切勿直接潑水，以免破壞電流絕緣。

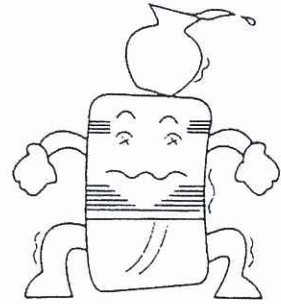

請勿擺放任何物件在機體上。



請每兩週清洗濾網一次(切勿使用40°C以上熱水、酒精、汽油或甲苯)。

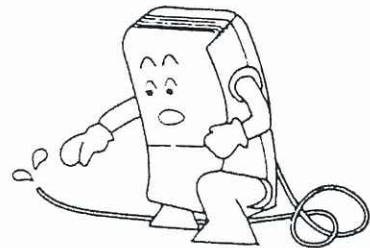

使用連續排水時，排水管須水平放置，不可高低不平及有纏繞情況。

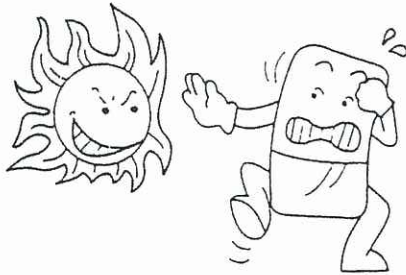

過濾網清洗後，請不要放置在太陽直射下曬乾，以避免變形。



移動、搬運機體前，請先倒出水箱內積水。

故障排除

發生以下的情況時，請立即停止機體運轉，並與總代理的維修及客戶服務部聯絡。

- ◎ 電源保險絲經常跳掣或熔斷時
- ◎ 誤將異物或水引入機內時
- ◎ 電源線或插頭異常發熱時

1. 需要召服務人員處理前

故障了嗎？

.....請先依照下列事項自行查驗一遍
(除了服務人員以外，請勿將側板打開)

故障狀況	請先查驗以下問題點
按動運轉開關抽濕機也不能啟動	<ol style="list-style-type: none">1. 水箱放置正確嗎？2. 電源插頭是否確實插入插座？3. 家中電源保險絲掣是否切斷了？4. 有沒有停電？
感覺除濕量太少	<ol style="list-style-type: none">1. 濾網是否太髒而阻塞通風？2. 室內溫度、濕度是否太低？3. 機器入風口和出風口是否堵塞？
長時間運轉而沒有停止運轉	<ol style="list-style-type: none">1. 門、窗是否打開太大？2. 室內是否有產生水蒸氣的物品？3. 室內空間是否太大？
噪音太大時	<ol style="list-style-type: none">1. 地面是否堅硬平坦？2. 是否抽濕機的放置不當，造成噪音的發生？

規格

型號	GP-216RC	GP-218RC
額定電壓	AC 220V/50Hz	
抽濕能力	16L/日 30°C RH90%	18L/日 30°C RH90%
額定消耗電功率	280W	390W
淨重	11kg	11.5kg
適用室溫	5°C - 35°C	
機體外觀尺寸	闊310X深230X高535	

CONTENT

● CAUTION	11
● ILLUSTRATION OF OUTLOOK	12
● DIRECTIONS	13-15
● IMPORTANT SAFETY PRECAUTIONS	16-18
● TROUBLESHOOTING	19
● SPECIFICATIONS	20

WARNING

- When there is an abnormal phenomenon, immediately turn off and unplug the machine. Please contact our Repairs and Customer Service Department. Never try to dismantle the carcass and repair the machine yourself .

CAUTION

1. Make sure the voltage of electric source is 220V/50Hz before connecting the power cord to socket.
 2. Do not turn on and off this dehumidifier by plugging in and out.
 3. Turn off the dehumidifier and unplug it before relocating.
 4. Do not try to clean the inner part of air inlet and outlet by stick.
 5. Place the dehumidifier on a flat and stable surface.
 6. Do not spray the dehumidifier with water.
 7. Do not spray the dehumidifier with pesticide or flammable liquid.
 8. Do not put heavy articles on the dehumidifier or let children play with it.
 9. Do not use it in a small hermetic room.
 10. Do not cover or block the air outlet opening.
 11. When the power cord is damaged, do not try to fix it yourself. Bring the dehumidifier to our Repairs and Customer Service Department for repair.
- Installation of grounding
To prevent electric shock, make sure the connection of electricity is properly grounded.
Never use gas or water pipes for grounding connection.

ILLUSTRATION OF OUTLOOK

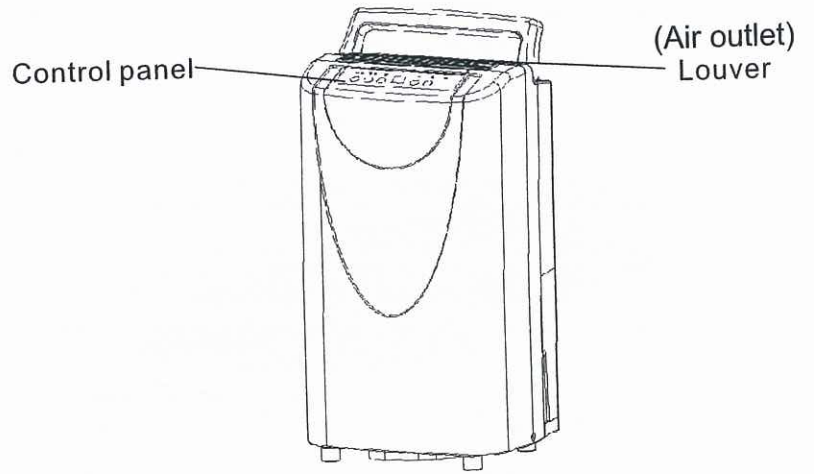

Figure 1

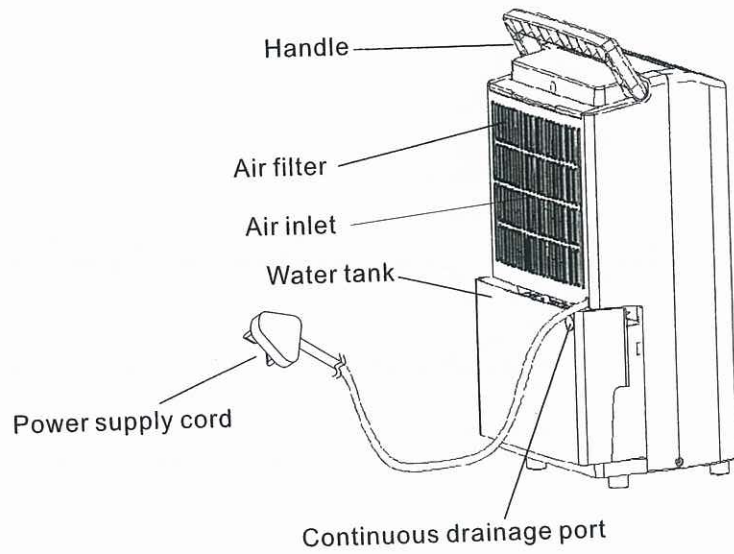
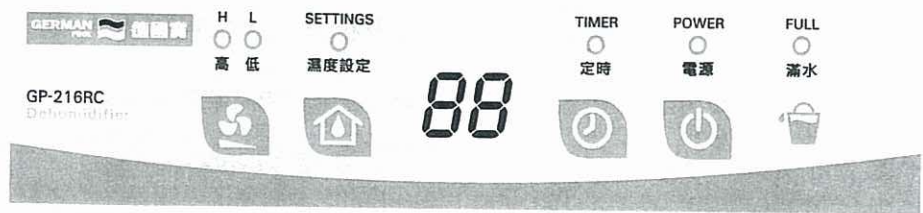

Figure 2

DIRECTIONS

● Illustration of operation panel



● Instructions of operation

1. Turning the unit On:

Buzzer will beep and humidity indicator shows the room humidity.

2. **POWER Button**

Press once to start operation, and the default humidity level is 60%. Press again to stop operation.

3. **TIMER Button**

- Press to program the time that the unit turns on.
- The maximum timer setting is 24 hours.
- If you want to cancel the timer programming, press the button and adjust the time to **00**

4. **SETTINGS (Adjustable Humidity) Button**

Press to set the desired humidity level in the room, which can be set in the order of: 60%, 65%, 70%, 75%, 80%, 40%, 45%, 50%, 55%, 60%. When the relative humidity of the room is lower than the set humidity, operation will stop automatically.

5. **H/L (Fan Speed) Button**

- Press to set the desired fan speed. It can be adjusted between high speed and low speed.
- Default fan speed is low.

Caution

1. When the set humidity level is higher than the actual humidity in the room, the machine will not operate.
2. When the FULL light is on (red light), the machine will stop running. Empty the water tank and put it back in position. The machine will start running again.
3. When the power is turned off, wait for at least 5 minutes before restarting.
This can protect the machine compressor from breaking down.
4. Please unplug the power cord if the machine will not be in use for an extended period.

● Features:

1. Auto - dehumidifying

After the humidity level is set, the machine will start and stop running automatically in order to maintain a stable humidity level. It helps to save electricity.

2. Design of humidity adjustable control (SETTINGS) button.

This dehumidifier is equipped with humidity adjustable control button. The relative humidity range is from 50% to 60%.

3. TIMER

Allows user to program the time that the unit turns on.

4. Cassette filter

Cassette filter design ensures easy removal and insertion of filter for cleaning purposes. (Pull up and get the filter out)

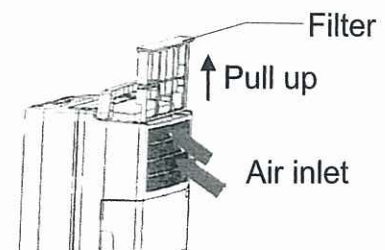

● Drainage

1. Water Tank is Full

- When the water tank is full, the machine will stop running and the FULL light will be on (red light).
- b. Please gently take out the water tank with the handles on two sides and pour out the water.
- c. After pouring, push the water tank back into the dehumidifier slightly until it is in position.

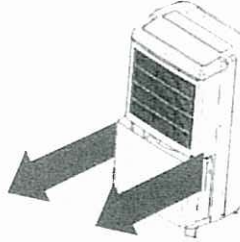

Caution

To prevent the compressor from breaking down caused by interrupted starting, please do not repeatedly "remove" and "reposition" the water tank.

2. Continuous Drainage

When draining continuously with a drain hose (Not provided):

- a. Take out the water tank.
- b. Open the drainage hole at the back of water tank using a sharp object. (A)
- c. Insert a \varnothing 9 mm PVC hose through the drainage port to drainage outlet. (B)
- d. Connect hose with drain outlet tightly.
- e. Put the water tank back in position.

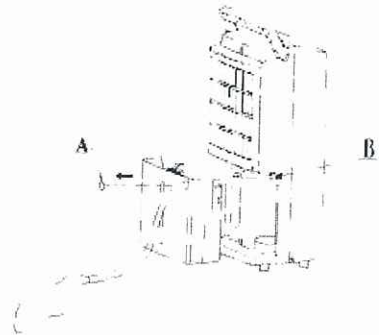

IMPORTANT SAFETY PRECAUTIONS

1. The applicable temperature range is from 5°C to 35°C (When the temperature is outside of this range, the protection switch of the machine may start to function, and the machine will stop running automatically. It is normal.)
2. When the room temperature is below 5°C, the absolute humidity of the environment will be very low and thus a dehumidifier is generally not needed.
3. When the dehumidifier is running, it is normal that room temperature will increase because of the heat generated by the running compressor.
4. When it reaches the set humidity, the machine will stop running. It will restart automatically when the humidity of the environment becomes higher than the set humidity again.
5. When the water tank is full, the machine will stop running.
6. Please do not put anything in the water tank in order to ensure its normal operation.
7. When the machine cannot start up or unexpectedly stops, please check it according to the following steps:
 - a. Check the plug and electric power source.
 - b. If the above mentioned are normal, please wait for 5 minutes and press it on again.
 - c. If all fails, please contact our Repairs and Customer Service Department.
8. Keep a clearance distance of no less than 20cm from air inlet/air outlet of machine as to secure its normal function.

● Maintenance



Do not place unit on uneven surface.

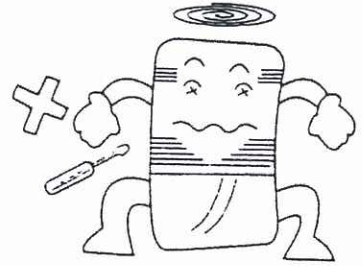

Do not insert any sharp objects into air inlet / air outlet.

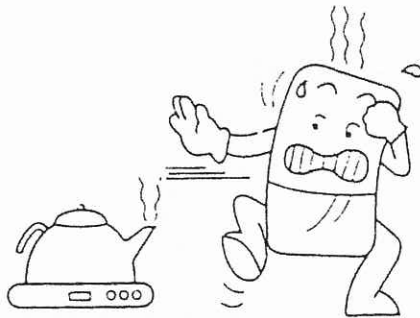

Do not operate unit near radiators / kettles.

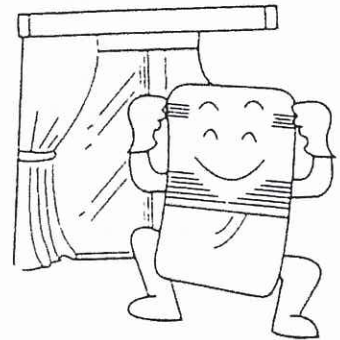

Do not operate unit near windows / doors open to outside air.

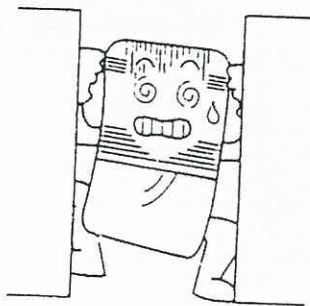

Please do not obstruct air passages to and from unit.



Unplug unit when it is not in use for an extended period.

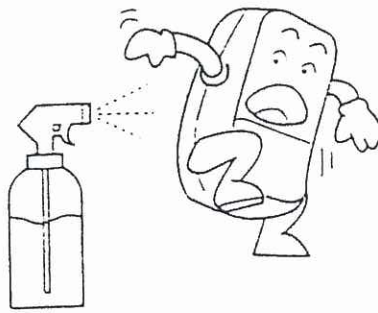

Do not spray any liquid onto unit.

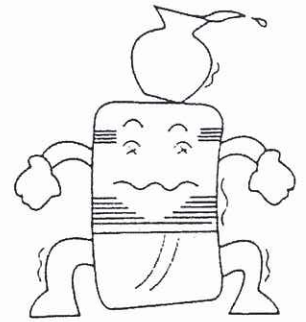

Do not put heavy objects on top of unit.



Wash the air filter once every 2 weeks with cold water. (Do not use water $>40^{\circ}\text{C}$, alcohol, petroleum or benzene)

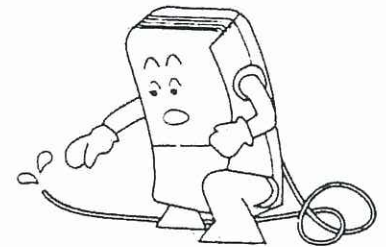

When draining water continuously, make sure drain hose is not tangled.

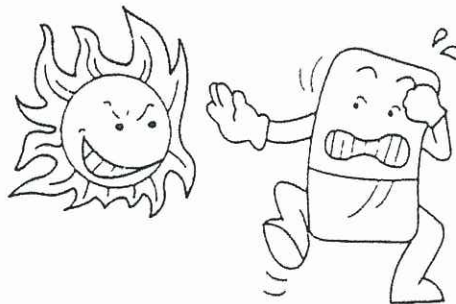

Do not place filter directly under the sun when drying.



Empty water tank before moving unit.

TROUBLESHOOTING

Please stop using the machine immediately and contact our Repairs and Customer Service Department when the following abnormal situations occur:

- The safety fuse melts frequently.
- There are some foreign objects or water inside the machine.
- The electric wire or plug gets extraordinarily hot.

Before you ask technicians for help

Troubleshooting?

... Please check your dehumidifier by yourself according the following guidelines. (Do not open the side plate unless a technician is with you.)

Symtoms	Please check the following items first.
The machine does not operate when you turn it on.	<ol style="list-style-type: none">1. Is the water tank in position?2. Have you plugged in a electric power source ?3. Is the safety fuse melted?4. Is there power supply shortage?
The machine is inefficient	<ol style="list-style-type: none">1. Is the filter too dirty?2. Are the temperature and humidity too low ?3. Are the air inlet and outlet blocked ?
The machine runs continuously without turning off.	<ol style="list-style-type: none">1. Are the door and windows open?2. Is there any other appliances producing steam in the room?3. Is the room too big ?
The machine is noisy.	<ol style="list-style-type: none">1. Is the surface where you place the dehumidifer stable and flat?2. Is the noise made by improper placing ?

SPECIFICATIONS

SPECIFICATION \ TYPE	GP-216RC	GP-218RC
TYPE	B TYPE	
READED VOLTAGE AND FREQUENCY	SINGLE 220V / 50Hz	
RATED LOAD (W)	280W	390W
RATED RUNNING CURRENT (A)	1.2A	1.7A
WEIGHT (KG)	11 KG	11 .5KG
RATED DEHUMIDIFYING CAPACITY	16L/DAY 30 °C RH90%	18L/DAY 30 °C RH90%
DIMENSION (mm)	W310 X D230 X H535	
APPLICABLE TEMPERATURE	5°C ~ 35°C	
CAPACITY OF WATER TANK	2.7 LITERS	

請填妥以下空格並與發票一併保存，以便維修時核對資料。用戶提供本公司之所有資料必須正確無誤，否則免費保用將會無效。
Please fill out the form below. This information and the purchase invoice will be required for any repairs. Warranty will be invalid if information provided is found to be inaccurate.

型號 Model No. : GP-216RC or GP-218RC

機身號碼 Serial No. : _____ 發票號碼 Invoice No. : _____

購買商號 Purchased From : _____ 購買日期 Purchase Date : _____

保用條例

德國寶產品設計優良，採用高品質原件製造。本公司所有家庭電器產品，須於正確使用及保養下才能表現其優越性能。由購買日期起一年之內，若發生內部原件之損壞，本公司將會免費為用戶提供維修服務。

* 貴戶須在購機十天內，以下列其中一種方式向本公司登記資料，保用手續方正式生效：

1) 填妥本公司網頁內之保用登記表格

www.germanpool.com/warranty

2) 填妥保用登記卡，並連同購機發票之副本一併郵寄到維修及客戶服務部

(本公司將不發還發票副本或登記卡)

* 此保用不包括：非家庭性質用途；燈泡及塑膠配件；技術人員上門之交通費用；因意外而造成的損壞(包括運輸及其它)；任何附件及輔助裝置；以及一切因人為、電源接合不當、不依說明書而錯誤或疏忽使用本機、經非本公司認可之安裝及不適當維修等等所引致之損壞。

維修及客戶服務部

德國寶(香港)有限公司
香港九龍土瓜灣馬頭角道116號
新寶工商中心高層地下2-3號室

電話：+852 2333 6249

傳真：+852 2355 7100

電郵：repairs@germanpool.com

Warranty Terms & Conditions

This German Pool product is made of high quality materials. It is designed to have its best performance under normal operations and care. Our Repairs & Customer Service Centre will provide rectification of any defect of manufacturing materials free of charge given that such defect is reported within 12 months from date of sale.

* This warranty is not valid until Customer's registration information is returned to and received by our Service Centre within 10 days of purchase via one of the following methods:

1) Visit our website and register online:

www.germanpool.com/warranty

2) Complete all fields on the attached Warranty Card and mail it back to our Repairs & Customer Service Centre along with a photocopy of the purchase invoice (Warranty Card and invoice copy will not be returned to Customer)

* Product must be used solely for domestic purposes. Customer should always follow the operating instructions. This warranty does not apply to: replacement of accessories and parts; transportation costs incurred during on-site repairs; damages caused by incorrect voltage, improper operations, unauthorized installation or repairs as well as accidents.

Repairs & Customer Service Centre

German Pool (Hong Kong) Limited
Room 2 & 3, Upper Ground Floor
Newport Centre, 116 Ma Tau Kok Road
Tokwawan, Kowloon, Hong Kong

Tel : +852 2333 6249

Fax : +852 2355 7100

Email : repairs@germanpool.com

此保用證只適用於香港

This warranty card is valid only in Hong Kong

GERMAN
POOL



德國寶

德國寶(香港)有限公司 German Pool (Hong Kong) Limited

香港九龍土瓜灣馬頭角道116號新寶工商中心高層地下2-3號室
Room 2 & 3, Upper Ground Floor, Newport Centre
116 Ma Tau Kok Road, Tokwawan, Kowloon, Hong Kong

電話 (Tel) :

+852 2333 6245
+852 2773 2888

傳真 (Fax) :

+852 2765 8215
+852 2365 6009

電郵 (E-mail) :

info@germanpool.com

www.germanpool.com