

GERMAN
POOL



德國寶

專業高速健康食品處理器

Professional High-Speed Food Processor

PRO-10

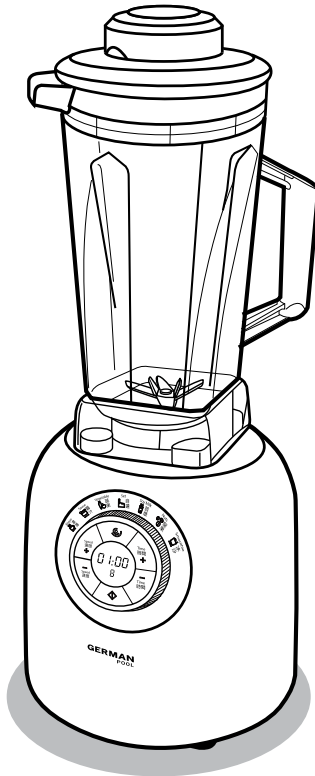

在使用之前請詳細閱讀「使用說明書」及「保用條例」，並妥為保存。
Please read these instructions and warranty information carefully
before use and keep them handy for future reference.



使用說明書 USER MANUAL

請即進行保用登記!

有關保用條款細則，請看本說明書最後一頁。

Please register your warranty information now !

For Warranty Terms & Conditions,

please refer to the last page of these operating instructions.

Table of Contents

Notice Before Use 04

Product Structure 05

Operating Instructions 07

- On / Off Button

- Time Setting

- Speed Setting

- Pulse Mode

- Preset Programs

Notice for Operation 09

- Lid, Measuring Cup, Seal Ring

- Other Important Notice

Care & Maintenance 10

Technical Specifications 10

Warranty Terms & Conditions 19

For Chinese instructions, please refer to P.11.

中文版說明書請參閱 P.11。

Notice Before Use

Important

For safety purposes, you should read the instructions carefully before using the appliance for the first time. Save the instructions for future reference.

The appliance is designed for domestic use and may only be installed and operated in accordance with this instruction manual.

Do not run the appliance without loading. It is strictly forbidden to operate this appliance without the presence of any liquids, solids or semi-solids inside the blending jar.

1. Before plugging in the appliance, check that the electrical rating shown on the rating plate corresponds with your house electricity supply.
2. Never immerse the unit base (including the base of the blending jar) of the appliance in water or other liquid, nor rinse it under the tap to avoid risk of short circuit or electric shock. If there is water inside the unit base, please contact German Pool or a licensed technician for repair.
3. Under no circumstances should the blending jar be immersed in any liquids. Do not spray or splash any liquids at the blending jar base. Do not directly rinse the blending jar base under the tap. The blending jar is not suitable for the dishwasher. If the blending jar base is sprayed or splashed wet, dry immediately.
4. Never put the power cord or plug into water for cleaning. Do not wipe the plug prongs with damp cloth, or plug in with wet hands.
5. Plug the appliance to the wall outlet properly & securely. Loose plug may lead to overheat or electric shock.
6. If the power cord is damaged, it must be replaced by the manufacturer or its service agents or qualified electricians in order to avoid a hazard.
7. Never leave the appliance unattended.
8. Keep hands and utensils out of the container while the motor is running to prevent the possibility of severe personal injury and/or damage.
9. Do not run the appliance without loading the blender jar.
10. To prevent spillage, do not put liquid in the blender jar exceeding the MAX line.
11. Do not expose the appliance to source of heat such as a radiator or direct sunlight. For good ventilation, do not place cloth underneath the appliance.
12. The appliance is for indoor use only.
13. Always operate with the lid in place. When processing hot beverages, properly secure the lid and measuring cup in place to avoid scalding due to spraying of hot liquids.
14. The appliance is not intended for use by persons (including children) with reduced physical, sensory or mental capabilities, or any individual lack of experience and knowledge, unless they have been given supervision or instruction by a person responsible for their safety. Children should be supervised to ensure that they do not play with the appliance.
15. Switch off the appliance and disconnect from supply before changing accessories. Also, unplug the power cord from the wall outlet when appliance is not in use, before putting on or taking off parts, and before cleaning.
16. If the motor has overheated, the temperature monitoring system will be triggered and the motor will stop. Switch off the appliance and let the motor cool down. The motor temperature monitoring system will reset after the food processor is unplugged from wall socket for 45 minutes.
17. The blade is very sharp. Use caution when handling the blade. Do not attempt to disassemble the blade assembly or touch any rotating parts.
18. Any servicing should be performed by an authorized service representative. Do not attempt to disassemble, repair or modify the appliance.

Product Structure

Part Descriptions

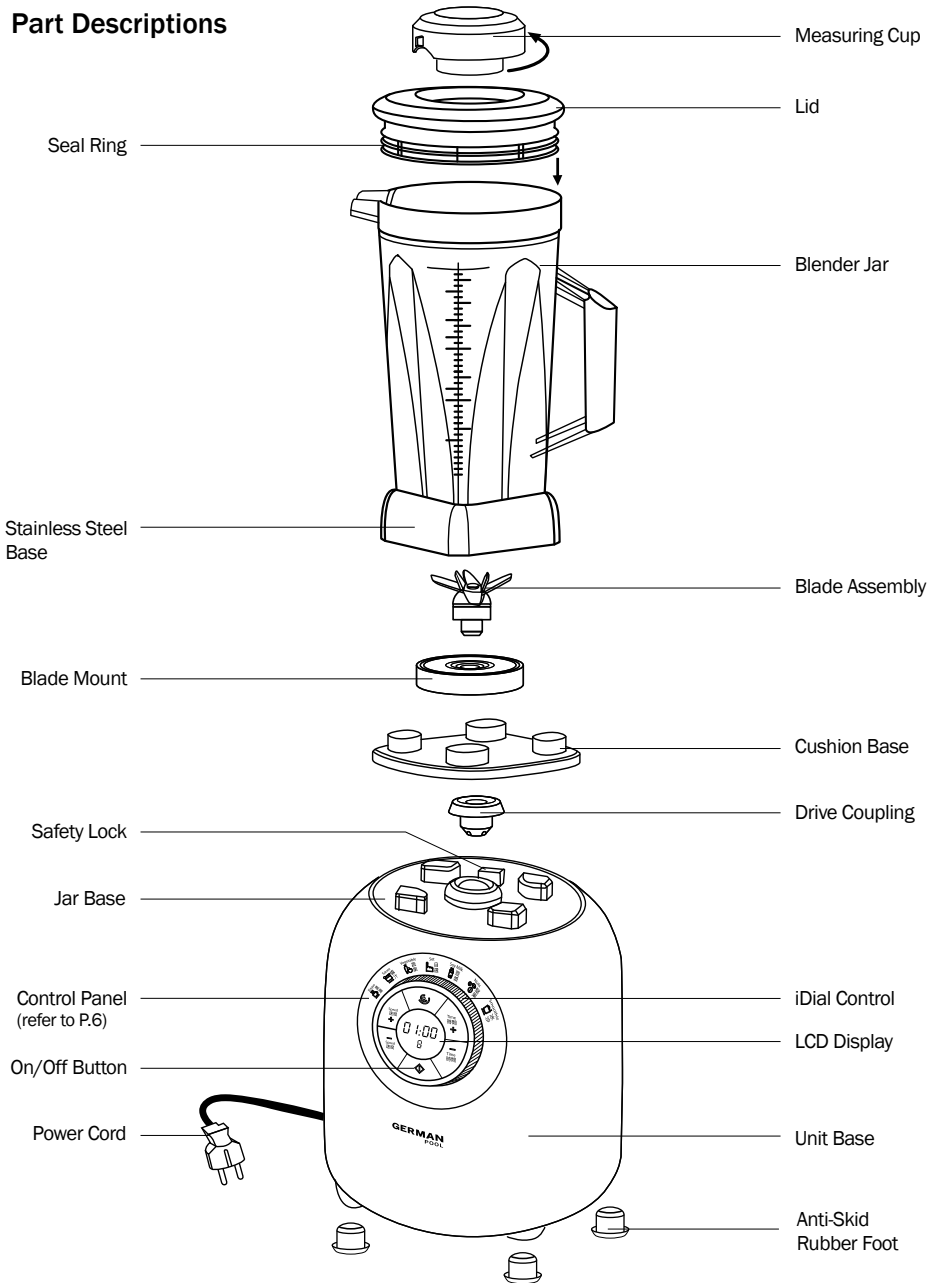

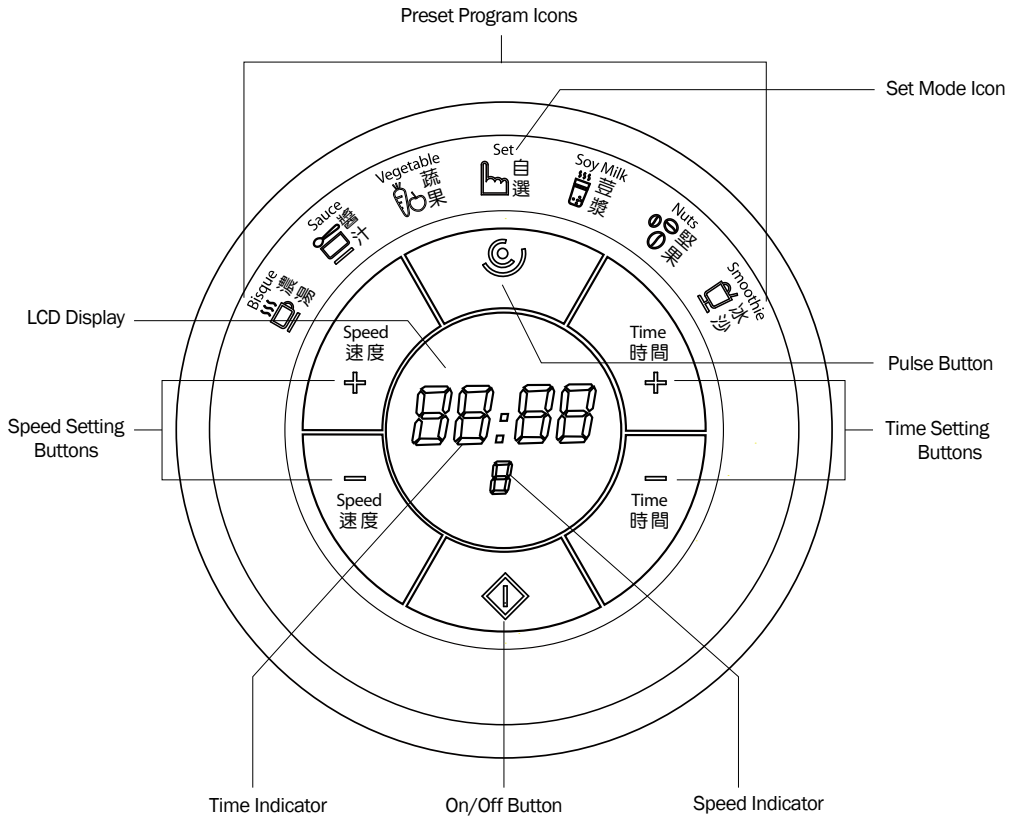

Product Structure

Control Panel



Operating Instructions



Attention

- Check and make sure the electrical rating shown on the rating label corresponds with the power supply in your house. Insert the plug into the socket, all icons and digits will light up. After 1 second, the unit will turn to “energy-saving” mode: only “On/Off ” button will light up; the other buttons and the display are off.
- If the food processor is left idle for 3 minutes, it will automatically turn to “energy-saving” mode. To resume operation, press the “On/Off ” button first to enter stand-by mode.
- After any program finishes, the blender resumes to stand-by mode.
- Do not run the appliance without loading. It is strictly forbidden to operate this appliance without the presence of any liquids, solids or semi-solids inside the blending jar.
- Under no circumstances should the blending jar be immersed in any liquids. Do not spray or splash any liquids at the blending jar base. Do not directly rinse the blending jar base under the tap. The blending jar is not suitable for the dishwasher. If the blending jar base is sprayed or splashed wet, dry immediately.
- Under no circumstances should the blending time exceed 1 minute when dry-grinding substances. It is advised to let the appliance rest for 5 minutes before resuming dry-grinding.



On/Off Button

- When the power is plugged, the unit will enter “energy-saving mode”. Press this button to enter “stand-by” mode (all buttons will light up).
- Once time and speed settings are set or a preset program is selected, press this button to start the operation. Press again to stop.

Set Mode

- Turn iDial to the position where “Set ” lights up, in order to set your preferred time and speed. “Set ” icon will flash once it is selected.



Time Setting and

- Set time under “Set” mode.
- When the preset time is less than 1 minute, pressing time setting buttons will increase or decrease 5 seconds.
- When the preset time exceeds 1 minute, pressing time setting buttons will increase or decrease 10 seconds.
- Press and hold the time setting buttons to fast forward the time setting.
- The longest time setting is 30:00 (minutes). If it is set to 00:00, the blender has no action.
- To continuously run the food processor, press “  ” to adjust the time setting to “88:88” under “stand-by” mode. Then, set your desired speed and press the “On/Off ” button. Press the “On/Off ” button again to stop.

Note: Do not operate continuously for more than 10 min each time.

Operating Instructions



Speed Setting and







- Set speed under “Set” mode. Speed 1 (the lowest speed) to speed H (the highest speed) can be set by pressing the speed setting buttons (“” & “”). The display shows speed 1, 2, 3, 4, 5, 6, 7, 8, 9, H. The speed can be modified anytime during operation.

Pulse (Momentary Blending)

Under “stand-by” mode, hold down the “Pulse ” button to run in Speed H. It will stop as soon as the button is released.



Preset Programs

To use the preset programs, the user should first select the desired preset program by turning iDial to the position where the program icon lights up (the selected program icon will flash once selected). Then, press the “On/Off ” button to start. Press the “On/Off ” button again to stop the blender.

Icon	Program	Descriptions	LCD Display	Suggested Recipes
	Bisque	Accelerate to speed 7 in 5 sec. Then accelerate to speed H in 5-10 sec and keep at this speed until finish. Total time is 8 min.	Time Display Speed Display	80g onion, 50g celery, 30g Chinese onion & 500g yellow sweet potato slightly stir-fried; 500ml boiled chicken stock, 300ml water, fresh cream, salt, sugar, pepper
	Sauce	Speed 8 for 2 sec and pause for 1 sec. Repeat for 5 cycles. Then speed H for 45 sec. Total time is 1 min.	Time Display Speed Display	300g peeled tomato, 200g tomato paste, 100g dried tomato, 50g basil, 10g parsley, 40g onion, 40g sugar, 20g salt, 10g minced garlic
	Soy Milk	Accelerate from speed 1 to speed 5 in 5 sec, and run at speed 5 for 25 sec; then speed 8 for 30 sec; finally speed H until finish. Total time is 6 min.	Time Display Speed Display	150g soy bean (soak in hot water for half an hour), 500ml distilled water, 60g sugar
	Smoothie	Speed H for 8 sec and pause for 2 sec. Run in cycles until finish. Total time is 30 sec.	Time Display Speed Display	100g fresh pineapple fruit (cut into pieces), 300ml pineapple juice, 500g ice cube
	Nuts	Speed 5 for 5 sec. Then Speed 8 for 2 sec and pause for 1 sec (repeat 10 times). Total time is 35 sec.	Time Display Speed Display	205g wheat, 80g coffee bean
	Vegetable	Speed H for 30 sec and pause for 2 sec; then speed 6 for 10 sec and pause for 2 sec; then speed H for 60 sec and pause for 2 sec; finally speed 6 for 10 sec. Total time is 1 min 56 sec.	Time Display Speed Display	1/4 cucumber, 1 stalk celery, 1 apple, 600ml distilled water

* The above recipes are for reference only. Actual ingredient portion is subject to personal preference.

Notice for Operation

- Insert the measuring cup to the lid (align the arrow on the cup to the  symbol on the lid and turn it to  position). Then press down on the lid of the blender jar to close. To open, pull up by the flap of the lid.
- During operation, close the lid tightly to avoid injuries due to spilling or splashing of hot liquids.
- Wind part of the power cord underneath the unit base. Prevent rubber foot from stepping on the power cord.
- When the food is too thick or there is too little liquid in the jar, the motor will be dragged to a low speed or cease to operate. Hence, when blending thick and sticky food, start blending from low to high speed. If it is still unable to blend, disconnect the power and stir the food inside the jar using a rubber stirrer to drive out the air trapped in food. Then close the lid and switch on the blender to continue the operation.
- When overheating is sensed, the temperature monitoring system will be activated and would stop the operation of the motor. In this case, put the appliance in a place with good ventilation to cool it down for 45 minutes. The system will be reset and you may resume the operation of the appliance.
- Keep hands and utensils out of the container while the motor is running to prevent the possibility of severe personal injury and/or damage.
- In making hot beverage or soup (such as soy milk, porridge, bisque, etc.), please ensure that the lid is secured tightly to the jar to prevent it from falling. Please be advised to start the operation at low speed first and then gradually increase the speed, or simply use the "Pulse" mode.
- When making sauces (eg. almond sauce, jam and sesame sauce), stuffing and nuts, put in between 2 and 3 cups of ingredients. The amount should neither be too large or too little. Keep the blending time below 2 min to prevent any burnt smell due to overheating. Too much ingredients may lead to overloading and overheating of the motor. In this case, wait till the motor temperature falls before operating again.
- Please put liquid and soft food into the jar before putting in hard food or ice cubes.
- When the operation finishes, please wait until the blade assembly comes to a complete stop before taking up the blender jar.
- If you notice a burnt smell from the blender, stop the operation immediately. It may be caused by the abrasion at the rubber cushion base if it is not properly assembled.
- Do not operate continuously for over 10 minutes each time.

Care & Maintenance

- Power plug must be disconnected before cleaning and repair.
- Clean surface of the blender jar with a soft cloth or sponge. The measuring cup and the seal ring can be detached for cleaning.
- The blender jar can be rinsed with water.
- The seal ring is detachable from the lid for easy cleaning.
- After cleaning, put the blender jar on its the side or upside down (Note 1) to dry*. Do not immerse the whole jar in water.
 - * To dry the blender jar in upside down position, remove the residual water with a dry cloth. Do not position near the sink or basin to avoid water spraying to the bottom part of the jar. This may cause rusting of the bearing and thus affect the performance of the blender.
- Do not immerse the unit base or power cord into water or other liquids. Clean the unit base by soft cloth.

A Friendly Reminder :

To effectively remove dirt on the jar and blades and help them last longer, do the following: add in water and lemon, close the lid and then press “Pulse ” button for 2 to 3 times. Replace liquid with clean water and repeat the above step.

Technical Specifications

Model No	PRO-10
Voltage / Frequency	220-240 V ~ 50-60 Hz
Rated Power	1,680 W
Dimensions	(H) 540 mm (W) 220 mm (D) 220 mm

- Specifications are subject to change without prior notice.
- If there is any inconsistency or ambiguity between the English version and the Chinese version, the Chinese version shall prevail.
- Refer to www.germanpool.com for the most up-to-date version of the User Manual.

目錄

注意事項 12

產品結構 13

操作說明 15

- 啟動/停止鍵
- 時間設定
- 速度設定
- 間歇運轉模式
- 智能快速程式

使用注意事項 17

- 量杯、杯蓋及密封圈
- 其他重要事項

清潔與保養 18

技術規格 18

保用條款 19

注意事項

重要說明

為安全起見，初次使用產品前請先細閱本說明書，並保存說明書，以便作參考之用。

本產品只供家居使用。請必須依照本說明書內的指示安裝及操作。

嚴禁空轉：在果汁杯內未有任何固體、流質食物或液體之情況下，切勿啟動本機。

1. 在使用本產品前，確認產品所標明的使用電壓，是否與接地插座電壓一致。
2. 請勿將整機（包括果汁杯底）泡在水中或對機座澆水，以免引起短路或觸電，機座主體內如有浸水，請立即聯絡本公司或聘請持牌之專業技術人員進行維修。
3. 任何情況下，切勿把整個果汁杯浸入任何液體泡浸；禁止向杯底澆水，不能直接沖洗果汁杯底部。果汁杯不適用於洗碗碟機。杯底濺濕後，請立即擦拭乾淨。
4. 機座的電源線和插頭不可用水或其他液體清洗或浸泡，插頭不可用濕布擦拭，手部潮濕時請勿插入或拔出插頭，以免引起觸電。
5. 本機在使用時，電源插頭必須完全插入插座，否則會容易造成觸電或因發熱而引起火災；請勿使用殘缺或鬆動的插座。
6. 請勿損傷電線及電源插頭；使用受損的電線易引起觸電、短路或火災；如電源線損壞或發生其他故障，切勿自行拆卸本機，必須由本公司或合資格的專業技術人員更換和維修。
7. 本機在使用時，切勿無人看管。
8. 果汁杯在主機座上時，切勿將手或任何用具、金屬、異物等放入果汁杯中，以免受傷或損毀攪拌部份。
9. 切勿將本機在無水情況下進行空轉。
10. 使用本產品時，果汁杯中的水或其他液體不能超過杯子上的最大刻度線。
11. 請勿將本機靠近熱源，請勿在機器下方放置抹布，以免造成散熱不良。
12. 本產品只可於室內環境中使用。
13. 操作時一定要蓋緊杯蓋，並裝上量杯。在製作熱飲時請務必蓋好杯蓋，並確定先使用低速運轉，以免高速會噴出熱液體，造成傷害。
14. 本產品並不適宜讓兒童、身體或心智殘障、缺乏經驗或知識的人士操作，除非該人士得到負責保障其安全的人士的監管或指引。
15. 更換配件前需要關機。當不使用機器、拆除或裝設配件或清洗時，亦須先拔掉插頭。
16. 摩打如超過負荷時，將自動停止運轉，此為摩打內的溫度偵測保護系統啟動，並非摩打故障。拔掉電源插頭，待本機冷卻45分鐘後即可重新使用。
17. 產品刀片非常鋒利，清洗時請必須特別小心，切勿自行拆除刀片或觸碰任何在運轉的部份。
18. 若本產品有任何問題，切勿自行拆卸、修理或改裝，以免造成自身傷害。如要維修，請聯絡本公司或持牌之專業技術人員。

產品結構

重要說明

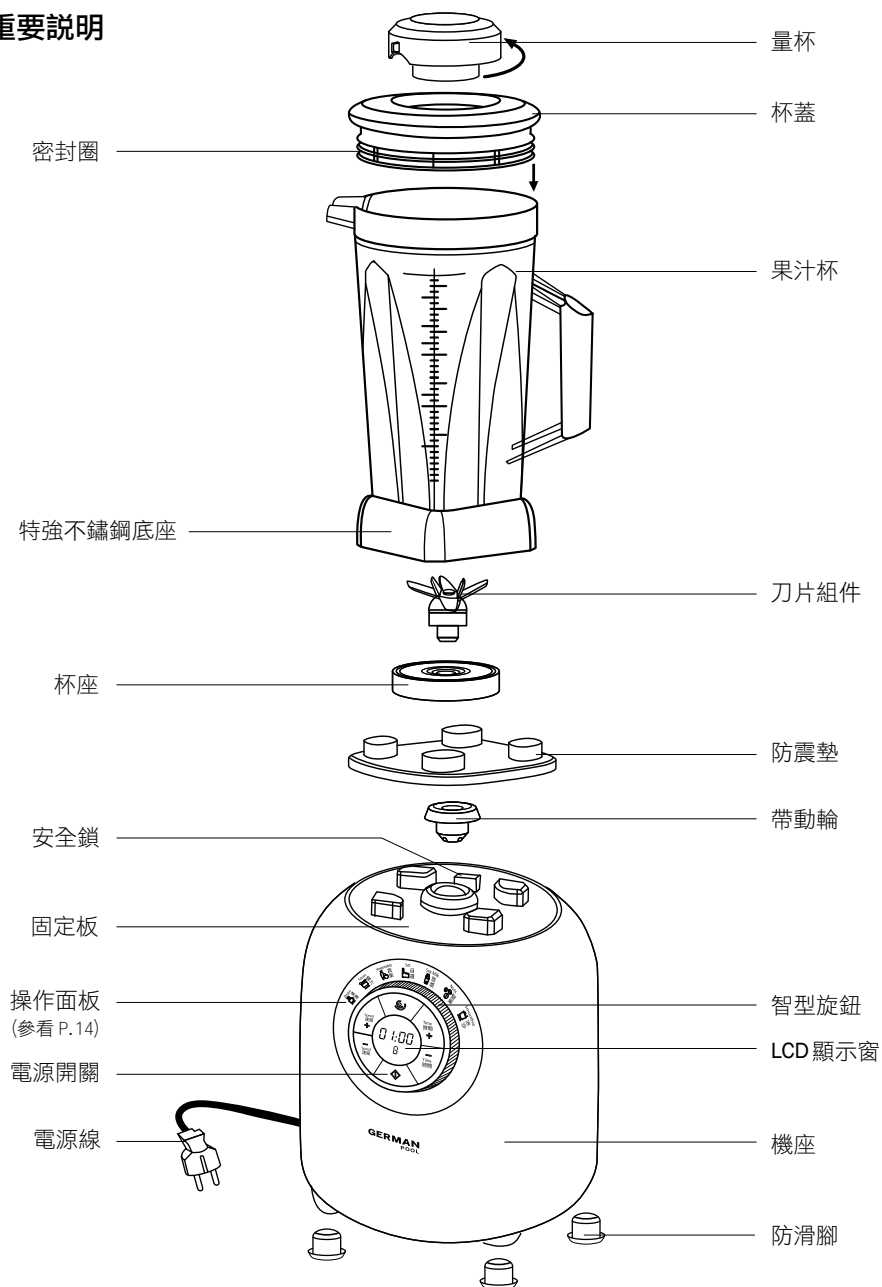

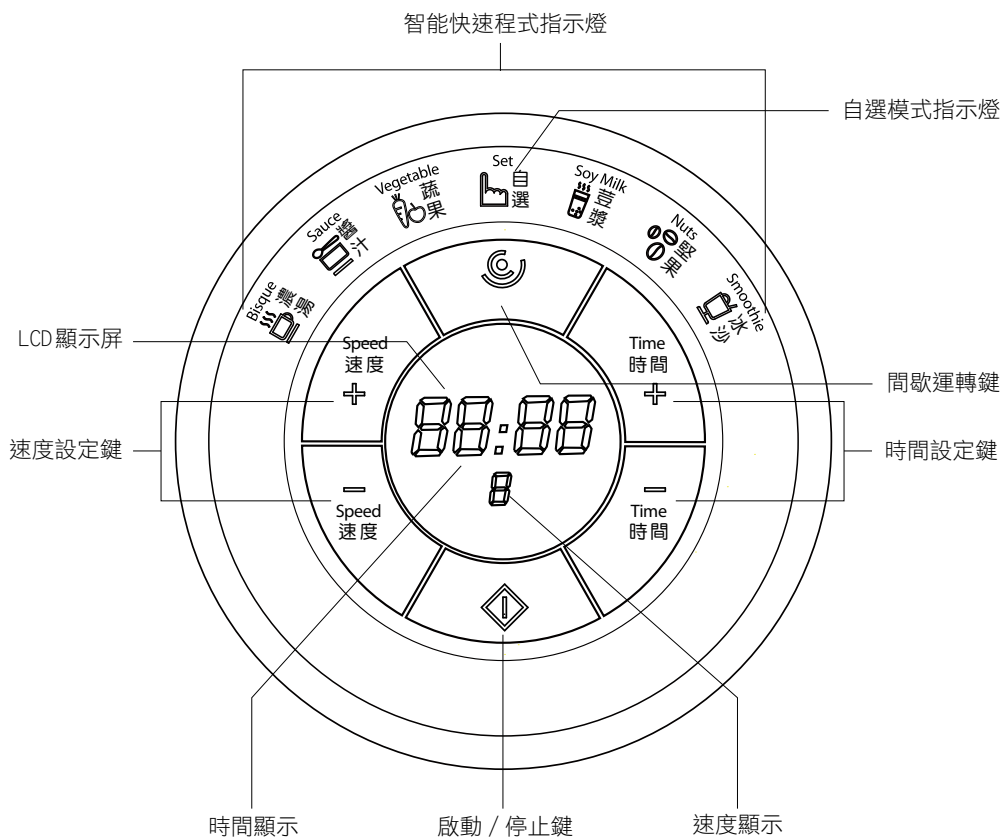

產品結構

操作面板



操作說明



重要

- 先將電源插頭插入與機身銘牌標示電壓一致的電源插座，按鍵圖案及數字會亮著，一秒後產品進入“省電模式”，此時只有“啟動/停止  ”鍵亮著，其餘按鍵及LCD顯示都會熄滅。
- 產品在“待機模式”下連續3分鐘無任何操作時，將會自動轉入“省電模式”。如要重新啟動，先按一下“啟動/停止  ”鍵以進入待機模式。
- 本機每次完成一個程式後，會返回至待機模式。
- 嚴禁空轉：在果汁杯內未有任何固體、流質食物或液體之情況下，切勿啟動本機。
- 任何情況下，切勿把整個果汁杯浸入任何液體泡浸；禁止向杯底澆水，不能直接沖洗果汁杯底部。果汁杯不適用於洗碗碟機。杯底濺濕後，請立即擦拭乾淨。
- 任何情況下，乾磨食材時不能連續操作超過1分鐘。如需連續乾磨，建議讓機件靜置5分鐘再重複操作。



啟動/停止鍵

- 通電後，產品進入“省電模式”，按一下此鍵進入“待機模式”(全部按鍵燈亮著)。
- 在設定好時間、速度或選擇好快速程式後，按此鍵啟動運作。再按一下停止運作。

自選模式

- 在待機模式下，將智型旋鈕扭至“自選  ”指示燈亮著的位置，以調校時間及速度。選擇本模式後，“自選  ”指示燈會閃動。

時間設定鍵 **TIME +** 及 **TIME -**

- 在自選模式下，設定運轉時間。
- 在1分鐘以內，每按一次時間設定鍵，增加或減少5秒。
- 在1分鐘以上，每按一次時間設定鍵，增加或減少10秒。
- 如持續按住時間設定鍵，時間數字便快速增加或減少。
- 時間設定最長為30:00分鐘，00:00則不運作。
- 若需要長時間連續運轉操作，只需按“**TIME -**”將時間設定為“88:88”，再選定運轉速度，然後按下“啟動/停止  ”鍵，便可開始連續工作；欲停止時，再按一下“啟動/停止  ”鍵便停止工作。

註：建議每次連續運轉不超過10分鐘。

操作說明



速度設定 SPEED 及 SPEED

在自選模式下，從1檔慢速到H檔高速，每按一次速度便增加或減少一個檔位，液晶顯示窗內容為speed 1, 2, 3, 4, 5, 6, 7, 8, 9, H；在使用過程中也可以隨時調整產品的工作速度。

間歇運轉(點動)

在待機模式下，按住“間歇運轉 ”鍵，摩打以H檔位連續運轉。



智能快速程式

用戶需將智型旋鈕扭至相應的程式圖示亮著的位置，以選擇所需的智能快速程式(所選圖示會閃動)。然後按下“啟動/停止 ”鍵，產品才運轉相應的智能快速程式。欲停止時，按下“啟動/停止 ”鍵，便停止工作。

圖示	程式	程式描述	LCD 顯示內容	參考食譜
	濃湯 Bisque	5秒內加速至7檔，5-10秒內加速至H檔，並維持在此檔位；總運轉時間為8分鐘。	時間顯示 速度顯示	洋蔥80克、西芹50克、大蔥30克及黃肉番薯500克略炒熟；清雞湯500毫升、清水300毫升、鮮忌廉、鹽、糖、胡椒粉
	醬汁 Sauce	以8檔啟動運轉2秒、暫停1秒，反覆此循環5次；接著加速至H檔運轉45秒，共需時1分鐘。	時間顯示 速度顯示	番茄肉300克、茄醬 200克、番茄乾100克、羅勒葉 50克、蕃茜10克、洋蔥40克、糖40克、鹽20克、蒜蓉10克
	熱豆漿 Soy Milk	五秒內加速至5檔，並在5檔位持續運轉25秒；接著加速至8檔，並運轉30秒；最後加速至H檔，並運轉至結束，共需時6分鐘。	時間顯示 速度顯示	黃豆150克並用熱水泡半小時、蒸餾水500毫升、白糖60克
	冰沙 Smoothie	以H檔運轉8秒，暫停2秒，以此循環；總運轉時間為30秒。	時間顯示 速度顯示	新鮮菠蘿肉(切件)100克、菠蘿汁300毫升、冰粒500克
	堅果 Nuts	以5檔運轉5秒；接著重複以下循環10次：先以8檔運轉2秒，然後暫停1秒；程式總共需時35秒。	時間顯示 速度顯示	小麥205克、咖啡豆80克
	蔬果 Vegetable	以H檔運轉30秒，暫停2秒；然後以6檔運轉10秒，暫停2秒；再以H檔運轉60秒，暫停2秒；最後以6檔運轉10秒。共需時1分56秒。	時間顯示 速度顯示	黃瓜1/4條、芹菜1棵、蘋果1個、蒸餾水600毫升

* 以上食譜只供參考，實際材料份量須視乎個人喜好而定。

使用注意事項

- 將量杯放入杯蓋中(量杯上的箭嘴對準杯蓋上的  標誌旋轉至  扣緊)，再將杯蓋蓋上果汁杯杯口，往下按入。再要打開時，只需將杯蓋往上拉即可。
- 產品操作時，請必須將杯蓋與量杯扣緊，避免讓杯內的食物濺出甚至造成危險。
- 操作時請將機座底下之電線沿凹位繞數圈至適當長度，並從防滑腳旁的凹位繞出，以免因機座壓著電線致令機身不能平放，影響操作。
- 低速下長時間攪拌、所打的食物太濃稠或液體太少等，都容易使摩打過熱導致停止運轉。所以，若食物較濃稠或水份較少的話，應先使用低速再調至高速；若還是無法攪拌，請關掉電源，取出果汁杯用塑膠工具略為攪拌，直到食物中的氣泡消除後重新開機使用即可。
- 當摩打內的溫度偵測保護系統被啟動時，摩打會自動停止轉動，此時請拔掉電源插頭，並將機座冷卻45分鐘(可放置通風處或使用風扇使其溫度降低，以達致散熱目的)，然後才啟動操作或改以間歇運轉鍵重新進行操作。
- 產品操作時，請勿將任何器具如湯匙、手、尖硬物體等放入杯內，以免刀片在高速運轉時遭外力撞擊而斷裂，造成危險或損壞。
- 製作豆漿、米糊、濃湯等熱飲時，一定要注意杯蓋與量杯是否扣緊。切勿一開始便將速度設在高速段，應由低速漸進到高速段，或改以間歇運轉模式操作。
- 如製作醬類(如杏仁醬、果醬及芝麻醬)、餡料或穀類雜糧時，材料份量必須介乎2杯和3杯之間，切勿放入過多或過少，而打磨的時間勿超過2分鐘，以免過熱而產生焦味。如材料太多會導致超過產品負載，有可能令摩打升溫，此時需待摩打溫躉降低後產品才可再次使用。
- 使用時請先放入液體及較軟的食物，硬的食物或冰塊較後放入。
- 操作完成後按停止鍵停止運轉。請必須等待產品完全停止運轉後才將杯子拿開，否則容易造成傳動輪損壞。
- 機座產生焦熱氣味時，請立即停止使用，那是機座上的橡皮固定墊未完全壓平而令部件摩擦生熱造成焦味、或所放的食物超過其負載使產品過熱而形成的異味。
- 建議每次不要連續使用本產品超過10分鐘。

清潔與保養

- 清潔、保養及維護前必須先拔掉電源插頭。
- 清潔時用軟布或海綿輕輕抹擦杯子表面，而杯蓋上的量杯及密封圈則可取出清洗。
- 使用後果汁杯可以用清水沖洗。
- 杯蓋密封圈為可拆卸部件，清洗時可將密封圈取下單獨清洗，然後再套上杯蓋，方便徹底清除杯蓋與密封圈上的食物殘渣。
- 清洗完畢後請將果汁杯橫放或倒放*，讓其自然晾乾，切勿將杯子整個浸泡於水中。
 - * 如將杯子倒放晾乾，請將杯底之水漬擦拭乾淨，並且遠離洗手盆，以防水滴不慎流到杯底，造成軸承生水鏽而損壞果汁杯。
- 切勿用清水沖洗機座，並切勿將機座或電源線等置於水中或其他液體中。可用清潔軟布擦拭機座。

溫馨提示：

為更有效清潔果汁杯內及刀片上之污垢，使杯及刀更耐用，可於果汁杯內加入清水及檸檬，然後蓋緊杯蓋，按“間歇運轉”鍵2至3次，將水倒去，再注入清水重覆之前程序便可。

技術規格

型號	PRO-10
電壓 / 頻率	220-240 V ~ 50-60 Hz
功率	1,680 W
機身尺寸	(H) 540 mm (W) 220 mm (D) 220 mm

- 產品規格及設計如有變更，恕不另行通知。
- 中英文版本如有出入，一概以中文版為準。
- 本產品使用說明書以 www.germanpool.com 網上版為最新版本。

請填妥以下空格並與發票一併保存，以便維修時核對資料。用戶提供本公司之所有資料必須正確無誤，否則免費保用將會無效。 Please fill out the form below. This information and the purchase invoice will be required for any repairs. Warranty will be invalid if information provided is found to be inaccurate.

型號 Model No. : PRO-10

機身號碼 Serial No. : _____ 發票號碼 Invoice No. : _____

購買商號 Purchased From : _____ 購買日期 Purchase Date : _____

保用條款

此保用提供德國寶產品之機件在正常使用下壹年保用，以及攪拌刀片永久保用(自購買日起計算)。

* 貴戶須在購機十天內，以下列其中一種方式向本公司登記資料，保用手續方正式生效：

- 1) 填妥本公司網頁內之保用登記表格
www.germanpool.com/warranty。
- 2) 填妥保用登記卡，並連同購機發票傳真至客戶服務部。

1. 未能出示購買發票正本者，將不獲免費維修服務。
2. 用戶應依照說明書的指示操作。本保用並不包括：
 - 上門安裝、檢驗、維修或更換零件之人工以及一切運輸費用；
 - 因天然與人為意外造成的損壞(包括運輸及其他)；
 - 果汁杯、任何塑膠附件及輔助裝置；
 - 電源接合不當、不依說明書而錯誤或疏忽使用本機所引致之損壞。
3. 於下列情況下，用戶之保用資格將被取消：
 - 購買發票有任何非認可之刪改；
 - 產品被用作商業或工業用途；
 - 產品經非認可之技術人員改裝或加裝任何配件；
 - 機身編號被擅自塗改、破壞或刪除。
4. 總代理有權選擇維修或更換配件或其損壞部份。
5. 產品一經被轉讓，其保用即被視作無效。

客戶服務及維修中心

德國寶(香港)有限公司
香港九龍紅磡暢通道 1 號
中旅貨運物流中心8樓
電話：+852 2333 6249
傳真：+852 2356 9798
電郵：repairs@germanpool.com

Warranty Terms & Conditions

Under normal operations, the product will receive a 1-year full warranty and the blade therein a lifetime warranty provided by German Pool (effective starting from the date of purchase).

* This warranty is not valid until Customer's registration information is returned to and received by our Service Centre within 10 days of purchase via one of the following methods:

- 1) Visit our website and register online:
www.germanpool.com/warranty.
- 2) Complete all fields on the attached Warranty Card and fax it back to our Customer Service Centre along with the purchase invoice.

1. Customer who fails to present original purchase invoice will be disqualified for free warranty.
2. Customer should always follow the operating instructions. This warranty does not apply to:
 - labour costs for on-site installation, check-up, repair, replacement of parts and other transportation costs;
 - damages caused by accidents of any kind (including transport and others);
 - blender jar, plastic parts and accessories;
 - operating failures resulted from incorrect voltage, improper operations and unauthorized installations or repairs.
3. This warranty is invalid if:
 - purchase invoice is modified by unauthorized party;
 - product is used for any commercial or industrial applications;
 - product is repaired or modified by unauthorized personnel, or unauthorized parts are installed;
 - serial number is modified, damaged or removed from the product.
4. German Pool will, in its discretion, repair or replace any defective part.
5. This warranty will be void if there is any transfer of ownership from the original purchaser.

Customer Service & Repair Centre

German Pool (Hong Kong) Limited
8/F, China Travel (Cargo) Logistics Centre
1 Cheong Tung Road
Hung Hom, Kowloon, Hong Kong
Tel : +852 2333 6249
Fax : +852 2356 9798
Email : repairs@germanpool.com

GERMAN
POOL 德國寶

德國寶(香港)有限公司 German Pool (Hong Kong) Limited

中國香港 Hong Kong, China

香港九龍土瓜灣馬頭角道116號
新寶工商中心2期113號室
Room 113, Newport Centre Phase II, 116 Ma Tau
Kok Road, Tokwawan, Kowloon, Hong Kong.
電話 Tel: +852 2773 2888
傳真 Fax: +852 2765 8215

中國內地 Mainland China

廣東省佛山市順德區
大良南國東路德順廣場三層
3/F, Takshun Plaza, Nanguo East Road,
Shunde, Foshan, Guangdong
電話 Tel: +86 757 2980 8308
傳真 Fax: +86 757 2980 8318

中國澳門 Macau, China

澳門宋玉生廣場263號
中土大廈15樓I座
Alameda Dr. Carlos D'Assumpcao No. 263,
Edif. China Civil Plaza, 15 Andar, I. Macau
電話 Tel: +853 2875 2699
傳真 Fax: +853 2875 2661



香港名牌十年成就獎
HONG KONG TOP BRAND TEN YEAR
ACHIEVEMENT AWARD



香港卓越名牌
HONG KONG
PREMIER BRAND



2007
CERTIFICATE AWARD FOR THE BEST BRAND ENTERPRISE
信譽最佳企業獎



中小企業
最佳拍檔大獎



© 版權所有。未獲德國寶授權，不得翻印、複製或使用本說明書作任何商業用途，違者必究。

© All rights reserved. Copying, reproducing or using the contents of this manual is not allowed without prior authorization from German Pool, violators will be prosecuted.

www.germanpool.com