

Smart UVC Clothes Drying Rack

ADR-289

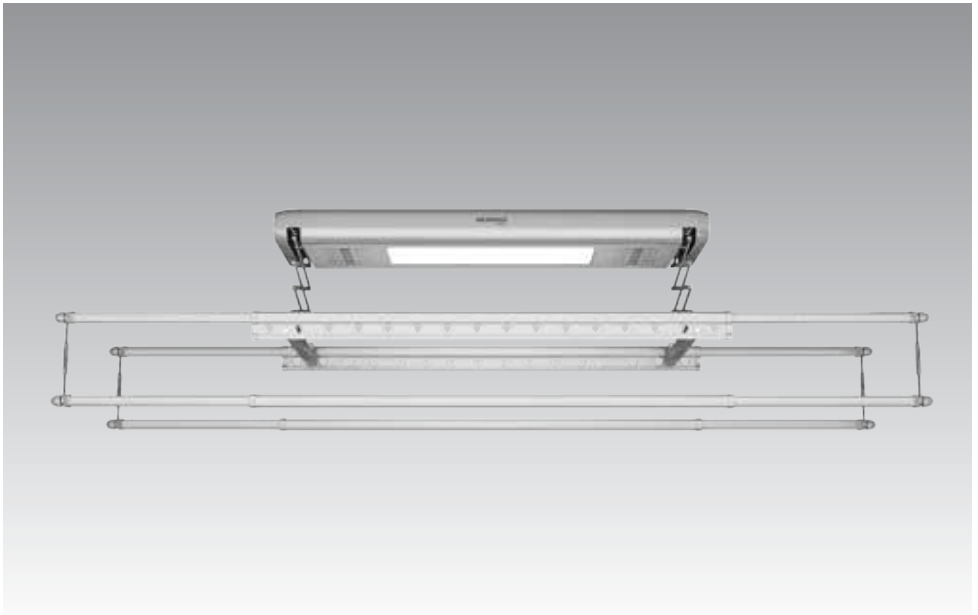

Online Warranty Registration



Please read these instructions and warranty information carefully before use and keep them handy for future reference.

USER MANUAL

請即進行保用登記！
有關保用條款細則，請看說明書最後一頁。

Please register your warranty information now !
For Warranty Terms & Conditions,
please refer to the last page of this user manual.

Table of Contents

Warnings & Safety Precautions 04

Product Structure 05

Installation Instructions 06

Operation Instructions 08

Troubleshooting 09

Technical Specification 10

Warranty Terms & Conditions 19

Warnings & Safety Precautions

WARNING!

Read all instructions carefully before using this product.

- This product is for domestic indoor use only. If this product is used for any commercial, industrial, rental or other purposes, product warranty will be VOIDED.
- This product is not intended for use by children or persons with reduced physical, sensory or mental capabilities, or lack of experience and knowledge, unless they have been given supervision or instruction concerning use of this product by an adult responsible for their safety.
- Mind your children and DO NOT let children play with this product.
- Cleaning and user maintenance shall not be made by children without supervision.
- Check the voltage indicated on the rating label before using this product.
- If the supply cord is damaged, it must be replaced by the manufacturer, its service agent or similarly qualified persons in order to avoid hazards.
- Unplug this product from the power source before cleaning and maintenance.
- Contact German Pool authorized service technician for repair or maintenance of this product.

1. The ceiling selected for installing this product must be sturdy so that the expansion anchors can be embedded fully and securely.
2. DO NOT sharing the same power supply with other electrical appliances.
3. For safety reasons, this product must be earthed, and the mains voltage must correspond to the voltage stated on this product's rating label. DO NOT use power cord with core thinner than 0.75mm². In order to ensure the normal operation of this product, the main body of this product must be installed at a location where rain cannot reach.
4. DO NOT disassemble this product by yourself. Repair work must be carried out by German Pool Customer Service & Repair Centre.
5. DO NOT use this product during thunderstorms.
6. The connecting fixed wiring center must be equipped with an all-pole disconnecting device with a contact gap of at least 3 mm.
7. If the power cord is damaged, in order to avoid danger, it must be replaced by professionals from the manufacturer's maintenance department or similarly qualified technicians.
8.  **WARNING!** This product is specifically for drying woven fabrics.

WARNING!

- This product is equipped with a UVC lamp. DO NOT stare directly at the UV light source.
- DO NOT look at the UVC light from any angle to avoid causing permanent damage to the eyes.
- DO NOT shine the UVC light on bare skin, and DO NOT expose your skin to the UVC light.
- When UVC Button is pressed, UVC sterilization will activate immediately! DO NOT stand below or near this product when pressing the UVC Button!
- Stand away from this product before pressing the UVC Button; if this product is installed on the balcony ceiling, close the curtains before pressing the UVC Button to activate UVC Sterilization Function; if this product is installed in a room, leave the room and shut the door before pressing the UVC Button to activate UVC Sterilization Function.

Product Structure

Main Body

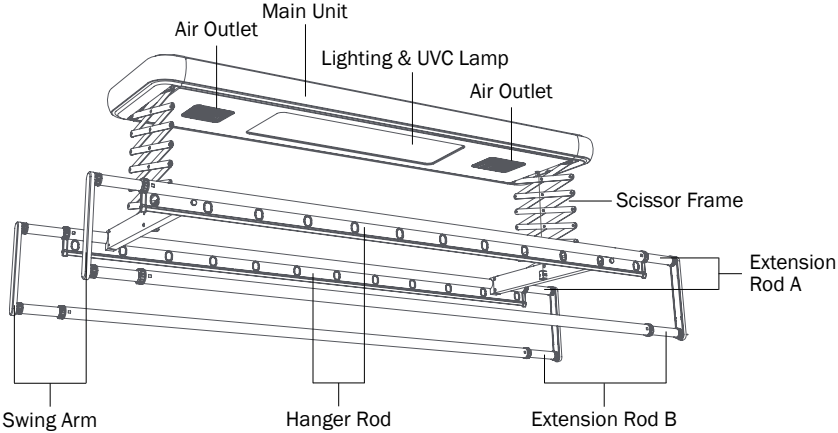

Installation Instructions

Installing The Expansion Anchors

1. Measure the ceiling installation location and mark the spots for the expansion anchors. If this product will replace your ceiling lamp, make sure to disconnect the power source of the ceiling lamp beforehand.
2. Tape the paper template guide to the ceiling, then drill four $\text{Ø}10 \times 80\text{mm}$ holes as marked on the template.
3. Install the expansion anchors into the drilled holes and tighten the screws. On one end, loosen the 2 lower bolts of the expansion anchors so that there is a 5mm gap between the upper and lower bolts; on the other end, take the 2 lower bolts off completely.

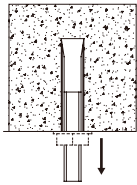

Take off 2 lower bolts on one end

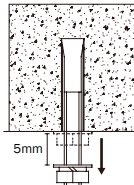
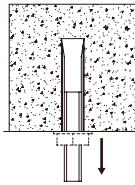

Loosen 2 lower bolts 5mm on the other end

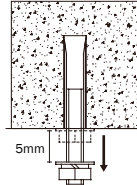

Installing The Main Unit

1. Remove the left and right end covers of the product, and insert one end of the main unit's frame plate into the 5mm space of the expansion anchors (between the upper and lower bolts), then tighten up the lower bolts to secure this side of the frame plate.

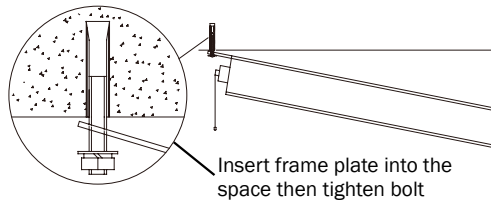

Insert frame plate into the space then tighten bolt

2. Fit the other side of the main unit frame plate over the other 2 expansion anchors (the ones with the lower bolts removed), then screw on the lower bolts so that the whole frame plate is securely installed.



3. Connect the wires correctly: Brown to live wire, blue to neutral wire, yellow-green to ground wire, then wrap the wires with insulating tape and lay them into the gap between the main unit and the ceiling.

Installation Instructions

Installing The Scissor Frame

1. Install one side of the scissor frame to the main unit and tighten the screws.

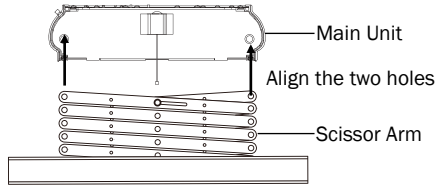

2. Thread the ball stopper of the steel cable into the small fitting on the scissor frame and make sure it is securely locked in. Repeat steps 1 and 2 with the other side of the scissor frame.
3. Snap on the end covers by aligning the latches with the holes on the main body and pushing inwards. Reconnect the power source of your original balcony lamp.

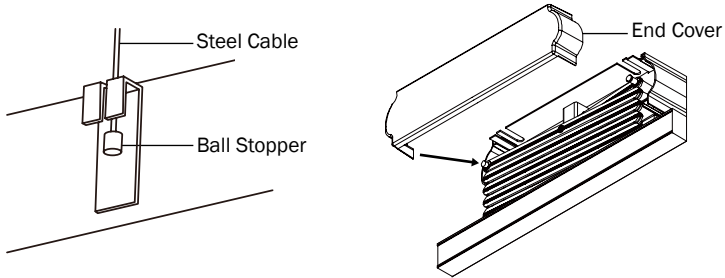

Installing The Extension Rods

1. Hook one end of the swing arm onto Extension Rod A, and the other end onto Extension Rod B, screw on the end cap tightly. Repeat with the other swing arm.
2. When you need to use Extension Rod B, swing it downwards, and swing it back up onto the hanger rod after use.

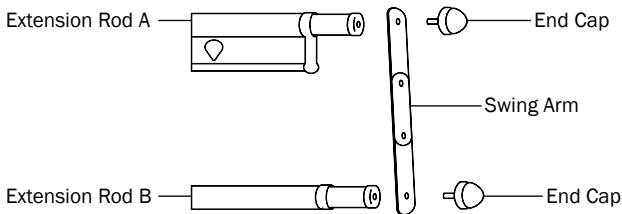

Installing The Hanger Rod

Align the screw hole at the base of the scissor frame with the screw hole near the end of the hanger rod, and tighten with screw. Do the same with the other three sides.



Operation Instruction

⚠ WARNING!

- This product is equipped with a UVC lamp. DO NOT stare directly at the UV light source.
- DO NOT look at the UVC light from any angle to avoid causing permanent damage to the eyes.
- DO NOT shine the UVC light on bare skin, and DO NOT expose your skin to the UVC light.
- Remote Control is equipped with a motion sensor, it is recommended that the remote control be installed next to the door of the room or balcony.



NOTE:

In any mode, when On/Off Button  is pressed, product will turn off immediately. Pressing On/Off Button  again will not turn the product back on. To turn the product back on, press your desired mode button.

Automatic Motion Sensor

This product is equipped with a motion sensor which will automatically turn the product on and off when motion is detected.





1. Automatically turn off UVC Lamp: When UVC Sterilization Lamp is turned on, and motion is detected near the remote control, the UVC lamp will automatically turn off and sterilization process will terminate.
2. Automatically turn on lighting: When power is connected, and motion is detected near the remote control, the lighting will automatically turn on; when lighting is turned on, if motion sensor does not detect any motion, the lighting will automatically turn off.

Operation Instruction



NOTE:









Automatic Lighting Function only activates when the surroundings are dark. In a brightly lit environment, it will not automatically turn the lighting on or off.

To manually deactivate or reactivate Motion Sensor, please follow these steps:

- Deactivate Motion Sensor: when motion sensor is activated, long-press Lamp button  and On/Off button  simultaneously until the remote control's blue indicator light blinks 3 times.
- Reactivate Motion Sensor: when motion sensor is deactivated, long-press Lamp button  and On/Off button  simultaneously until the remote control's blue indicator light blinks 2 times.

How To Pair The Remote Control

If the product does not respond to the remote control, please pair them again: Disconnect the power source to the Clothes Drying Rack, wait 1 minute then reconnect the power. Place the remote control beneath the clothes drying rack, and simultaneously long-press Up  and Stop  buttons until the clothes drying rack beeps twice to signal pairing is successful.

Button		Function
 LAMP	Lighting Lamp	Press this button to turn the lighting on or off.
 UP	Up	<ul style="list-style-type: none"> • Press this button to raise the hanger rod. • Hanger rod will automatically stop when it is completely raised up.
 ON/OFF	On/Off	In any mode, press this button to turn off the product.
 STOP	Stop	Press this button to stop the hanger rod from rising or lowering.
 DRY	Air Dry	<ul style="list-style-type: none"> • Press this button to turn on or turn off Air Dry Function. • Maximum drying time is 2 hours. Air Dry Function will automatically turn off after 2 hours.
 UVC	Sterilize	<ul style="list-style-type: none"> • Press this button to turn on or turn off UVC Sterilization Function. • Maximum UVC sterilizing time is 30 minutes. UVC Sterilize Function will automatically turn off after 30 minutes. <p>⚠ WARNING! When this button is pressed, UVC Sterilization will activate immediately! DO NOT stand below or near this product when pressing the UVC Button!</p> <p>⚠ WARNING! Stand away from this product before pressing the UVC Button; if this product is installed on the balcony ceiling, close the curtains before pressing the UVC Button to activate UVC Sterilization Function; if this product is installed in a room, leave the room and shut the door before pressing the UVC Button to activate UVC Sterilization Function.</p>
 HEAT	Heat Dry	<ul style="list-style-type: none"> • Press this button to turn on or turn off Heat Dry Function; when Heat Dry Function is turned on, Air Dry Function will automatically turn on simultaneously. • Maximum drying time is 2 hours. Heat Dry Function will automatically turn off after 2 hours, and Air Dry Function will automatically turn off as well. • When Heat Dry Function is turned off, the fan will run for an extra 10 seconds to dissipate residual heat.
 DOWN	Down	<ul style="list-style-type: none"> • Press this button to lower the hanger rod. • Hanger rod will automatically stop when it has lowered down completely.

Troubleshooting

Problem	Reason	Solution
Remote control does not respond	There is no power to the main unit	Connect the power source
	Remote control battery is dead	Replace the battery
UVC lamp does not light	Scissor frame is not retracted fully	Turn on the UVC lamp again after the scissor frame has retracted fully
	UVC lamp is broken	Replace the UVC lamp
Hanger rod stopped midway	There is an obstruction stopping the hanger rod	Remove the obstruction
	Motor overheat protection	Let the product cool down before restarting
Lighting lamp does not light	There is no power to the main unit	Connect the power source
	Lamp is broken	Replace the lamp

WARNING!

If problem persists, please contact German Pool Customer Service & Repair Centre for assistance. DO NOT disassemble this product by yourself.

Technical Specification

Model	ADR-289
Power	893 W
Voltage	220-230 V~
Frequency	50 Hz
Product Dimensions	Retracted: (H) 135±10mm (W) 1290±10mm (D) 520±5mm
	Extended: (H) 1550±10mm (W) 2265±10mm (D) 505±5mm
Net Weight	9.6 kg
Maximum Load	35 kg

- Specification is subject to change without prior notice.
- If there is any inconsistency or ambiguity between the English version and the Chinese version, the Chinese version shall prevail.
- Refer to www.germanpool.com for the most update version of the user manual.

目錄

警告及注意事項 11

產品結構 12

安裝說明 14

使用說明 16

故障檢修 17

技術規格 18

保用條款 19

警告及注意事項

⚠ 警告！

使用本產品前，請仔細閱讀所有說明。

- 本產品只限家居室內日常使用，如產品作任何商業、工業、出租或其他用途，保用證即告失效。
- 請勿讓兒童或身體有殘障、精神不健全及對本產品缺乏經驗或知識的人士單獨使用本產品；如需使用，必須要在負責任的成年人監管下方可使用。
- 應照顧好兒童，確保他們不會玩耍本產品。
- 無成年人監管下，勿讓兒童清潔及維護本產品。
- 使用前，請先檢查所有電壓是否與本產品標籤上的電壓相符。
- 如果電源線損壞，為免發生意外，電源線必須由廠方、廠方指定的維修中心或同等合格的技术人員進行更換。
- 清潔或檢查本產品前，必須先關機及拔掉插頭。
- 請聯繫德國寶授權的技术人員進行維修或保養本產品。

1. 選擇的天花板頂面安裝部位要結實，確保膨脹螺絲安裝到位。
2. 本產品嚴禁與其他電器產品串聯或並聯。
3. 為確保安全，必須連接地線，且只能使用本產品上標明的電源，嚴禁使用小於0.75平方毫米的電源線。為確保本產品正常運作，主機的安裝位置，應定在無雨水淋到的地方。
4. 嚴禁私自拆卸本產品，需要進行維修時，必須聯絡德國寶客戶服務及維修中心。
5. 雷雨過程中，嚴禁使用本產品。
6. 連接的固定布線中心必須配有其觸點開距大於3毫米的全極斷開裝置。
7. 如電源軟線損壞，為避免危險，必須由製造商、其維修部或類似部門人員更換。
8. ⚠ 警告！本產品僅用於乾燥水洗的紡織物。

⚠ 警告！

- 本產品配備紫外線燈，嚴禁凝視紫外線光源。
- 嚴禁任何角度望紫外線，以免對眼睛造成永久性損害。
- 嚴禁將紫外線照射皮膚，或讓皮膚暴露在紫外線之中。
- 當按下「消毒鍵」鍵後，UVC消毒燈會立即開啟！嚴禁在產品下方或附近按「消毒鍵」！
- 按「消毒鍵」前必須遠離本產品；如產品安裝在露台，必須先拉上窗簾再按此鍵使用UVC消毒功能；如產品安裝在房間內，必須先離開該房間並關上門後再按此鍵使用UVC消毒功能。

產品結構

主機

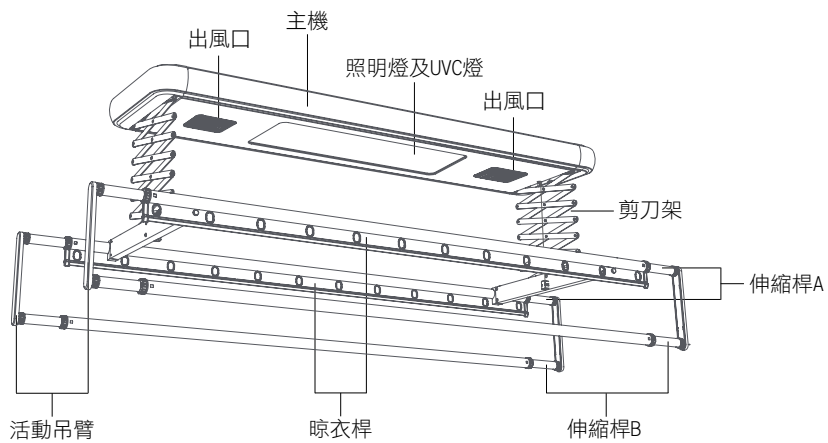

安裝說明

打膨脹螺絲

1. 測量天花板安裝位置的尺寸，確定安裝位置並作好記號。如果本產品將會代替原有的露台燈，先切斷露台燈的電源。
2. 將安裝模板黏貼在天花板上，然後按模板上的指示打出4個 $\text{Ø}10 \times 80$ 毫米的孔。
3. 將膨脹螺絲打入天花板後擰緊螺絲，將一邊的2粒螺絲下端的外螺母鬆開，使上螺母和外螺母之間的距離為約5mm；另一邊的2粒螺絲取下端的外螺母。

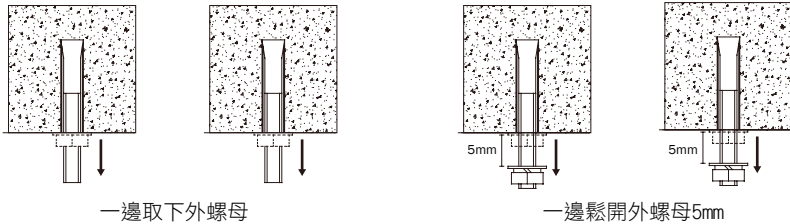

安裝主機

1. 拆下主機左右兩邊的裝飾外蓋，將主機一邊的螺絲卡槽插在膨脹螺絲的上螺母和外螺母之間的5mm的空間，然後擰緊外螺母，固定這一邊的主機框架。

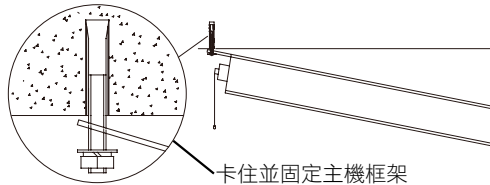

2. 主機另一邊的螺絲卡槽對準已拆下外螺母的膨脹螺絲裝上，然後裝回外螺母並擰緊，固定整個主機框架。

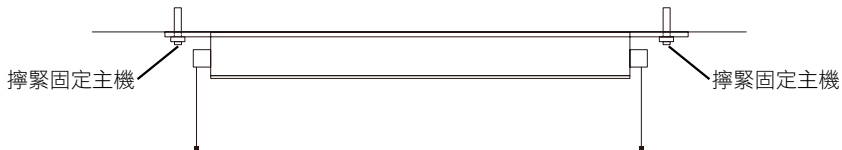

3. 正確連接好電線：棕色接火線，藍色接零線，黃綠雙色接地線，然後用絕緣膠包好放進主機與天花板的縫隙裡。

安裝說明

安裝剪刀架

1. 將剪刀架的一側安裝到主機上，擰緊升降架螺絲。

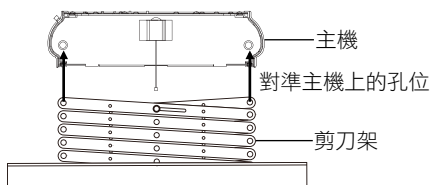

2. 將鋼索的球形卡頭插入剪刀架上的小孔，確保穩固卡緊。重複步驟1及2將剪刀架另一側裝上。
3. 將裝飾外蓋裝在主機左右兩端；然後重新連接原有露台燈的電源。

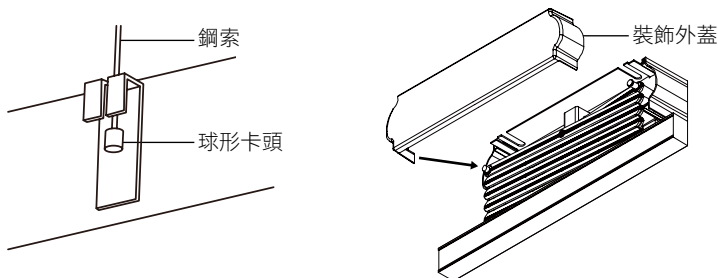

安裝伸縮桿

1. 將活動吊臂裝在晾衣桿的伸縮桿（伸縮桿A）及外置伸縮桿（伸縮桿B）的左右2端，擰入外蓋固定好即成。
2. 使用時，可將伸縮桿向下伸展；使用完畢後放回晾衣桿上即可。

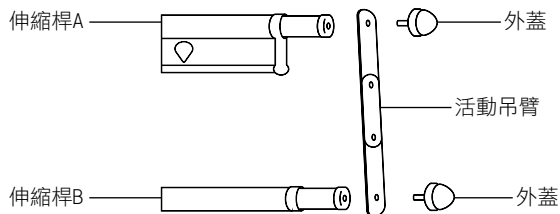

安裝晾衣桿

1. 將剪刀架底部對準晾衣桿近尾部的螺絲孔，然後用螺絲固定。
2. 重覆將2邊晾衣桿的4個螺絲孔固定好即成。

使用說明

⚠ 警告！

- 本產品配備紫外線燈，嚴禁凝視紫外線光源。
- 嚴禁任何角度望紫外線，以免對眼睛造成永久性損害。
- 嚴禁將紫外線照射皮膚，或讓皮膚暴露在紫外線之中。
- 由於遙控器配備動態感應器，建議將遙控器安裝在出入口位置，例如房間門邊或露台門邊。



注意：

在任何模式下按「開關鍵 ⏻」關機後，如再按「開關鍵 ⏻」將不會開機（再按「開關鍵 ⏻」無反應）。如需開機，請按所需模式的按鍵。

動態感應功能

本產品的遙控器配備動態感應器，透過感應人體活動達至自動開關功能。

1. 自動關閉UVC消毒燈：在啟動UVC消毒燈後，如在消毒過程中檢測到人體移動（當人體靠近遙控器時），產品將自動關閉UVC消毒燈，中止消毒。
2. 自動開關照明燈：在產品通電後如檢測到人體移動（當人體靠近遙控器時），產品將自動開啟照明燈；在照明燈亮著後，如檢測不到人體移動，產品將自動關閉照明燈。

注意：

「自動開關照明燈功能」只在環境幽暗的情況下啟動，如照明充足，將不會自動開啟或關閉照明燈。如需停用或啟用動態感應功能，請按以下方法操作。

- 停用動態感應功能：在動態感應功能開啟時，同時長按「照明鍵 ☀」及「開關鍵 ⏻」，直至遙控器上的藍色指示燈連續閃爍3次。
- 啟用動態感應功能：在動態感應功能停用時，同時長按「照明鍵 ☀」及「開關鍵 ⏻」，直至遙控器上的藍色指示燈連續閃爍2次。

使用說明

遙控器對碼方法

如使用遙控器時產品無反應，請將遙控器重新對碼：切斷乾衣架電源，等待1分鐘後重新開電源；然後將遙控器置於乾衣架下方，同時按「上升鍵 \wedge 」和「停止鍵 \odot 」直至聽到乾衣架發出蜂鳴器聲響兩聲，表示對碼成功。

按鍵		說明
 LAMP	照明鍵	按此鍵開啟或關閉照明燈。
 UP	上升鍵	<ul style="list-style-type: none">· 按此鍵後晾衣桿上升。· 直至晾衣桿完全回收後自動停止。
 ON/OFF	開關鍵	在任何模式下，按此鍵關機。
 STOP	停止鍵	當晾衣桿上升或下降期間按此鍵，晾衣桿停止移動。
 DRY	風乾鍵	<ul style="list-style-type: none">· 按此鍵開啟或關閉風乾功能。· 每次使用風乾功能的最長運行時間為 2 小時，2 小時後自動關閉。
 UVC	消毒鍵	<ul style="list-style-type: none">· 按此鍵開啟或關閉UVC消毒功能。· 每次使用UVC消毒功能的最長運行時間為30分鐘，30分鐘後自動關閉。 <p>⚠ 警告！當按下此鍵後，UVC消毒燈會立即開啟！嚴禁在產品下方或附近按此鍵！</p> <p>⚠ 警告！按此鍵前必須遠離本產品；如產品安裝在露台，必須先拉上窗簾再按此鍵使用UVC消毒功能；如產品安裝在房間內，必須先離開該房間並關上門後再按此鍵使用UVC消毒功能。</p>
 HEAT	烘乾鍵	<ul style="list-style-type: none">· 按此鍵開啟或關閉烘乾功能；開啟烘乾功能後，風乾功能自動同步開啟。· 每次使用烘乾功能的最長運行時間為 2 小時，2 小時後自動關閉，風乾功能亦自動同步關閉。· 關閉烘乾功能後，風扇會延遲約10秒關閉進行散熱。
 DOWN	下降鍵	<ul style="list-style-type: none">· 按此鍵後晾衣桿向下伸出。· 直至晾衣桿完全伸出後自動停止。

故障檢修

故障現象	可能原因	處理方法
按遙控器後沒反應	主機沒通電	接通電源
	遙控器電量不足	更換電池
UVC消毒燈不亮	晾衣杆未有完全回收	將晾衣杆完全回收後再開啟
	UVC消毒燈燒壞	更換UVC消毒燈
晾衣杆移動期間突然停止	遇到障礙物	移開障礙物
	摩打過熱保護	待產品冷卻後再次接通電源
燈具不亮	主機沒通電	接通電源
	燈具損壞	更換燈具

⚠ 警告！

如無法順利排除故障，請與客戶服務及維修中心聯絡，嚴禁非專業人員對本機拆卸。

技術規格

型號	ADR-289
功率	893 W
電壓	220-230 V~
產品尺寸	收納：(H) 135±10mm (W) 1290±10mm (D) 520±5mm
	展開：(H) 1550±10mm (W) 2265±10mm (D) 505±5mm
淨重	9.6 kg
承重上限	35 kg

- 產品規格及設計如有變更，恕不另行通知。
- 中英文版本如有出入，一概以中文版為準。
- 本產品使用說明書以www.germanpool.com網上版為最新版本。

保用條款

此保用提供德國寶產品之機件在正常使用下壹年保用(自購買日起計算)。

Warranty Terms & Conditions

Under normal operations, the product will guarantee a 1-year warranty provided by German Pool (effective from the date of purchase).

* 貴戶須在購機十天內，以下列其中一種方式向本公司登記資料，保用手續方正式生效：

- 1) 填妥德國寶VIP手機應用程式保用登記表(掃描右方二維碼)
- 2) 填妥本公司網頁保用登記表
www.germanpool.com/warranty
- 3) 填妥保用卡郵寄至本公司。



* This warranty is not valid until customer registration information is received by our Service Centre within 10 days of purchase via one of the following means:

- 1) Visit our VIP App and register online:
(Scan the QR Code on the left)
- 2) Visit our website and register online:
www.germanpool.com/warranty
- 3) Complete the attached Warranty Card and mail it back to our Customer Service Centre.



另請填妥以下表格並與正本發票一併保存，以便維修時核對資料。用戶提供之所有資料必須正確無誤，否則免費保用將會無效。 Please fill out the form below. This information and the original purchase invoice will be required for any repairs. Warranty will be invalidated if information provided is found to be inaccurate.

型號 Model No. : ADR-289

機身號碼 Serial No. : _____ 發票號碼 Invoice No. : _____

購買商號 Purchased From : _____ 購買日期 Purchase Date : _____

1. 未能出示購買發票正本者，將不獲免費維修服務。
2. 用戶應依照說明書的指示操作。本保用並不包括：
 - 上門安裝、檢驗、維修或更換零件之人工以及一切運輸費用；
 - 因天然與人為意外造成的損壞(包括運輸及其他)；
 - 電源接合不當、不依說明書而錯誤或疏忽使用本機所引致之損壞。
3. 於下列情況下，用戶之保用資格將被取消：
 - 購買發票有任何非認可之刪改；
 - 產品被用作商業或工業用途；
 - 產品經非認可之技術人員改裝或加裝任何配件；
 - 機身編號被擅自塗改、破壞或刪除。
4. 總代理有權選擇維修或更換配件或其損壞部份。
5. 產品一經被轉讓，其保用即被視作無效。

1. Customer who fails to present original purchase invoice will not be eligible for free warranty service.
2. Customer should always follow the operating instructions. This warranty does not apply to:
 - labour costs for on-site installation, check-up, repair, replacement of parts and other transportation costs;
 - damages caused by accidents of any kind (including material transfer and others);
 - operating failures resulting from applying incorrect voltage, improper usage, and unauthorized installations or repairs.
3. This warranty is invalid if:
 - the purchase invoice is modified by an unauthorized party;
 - the product is used for any commercial or industrial purposes;
 - the product is repaired or modified by unauthorized personnel, or unauthorized parts are installed;
 - the serial number is modified, damaged or removed from the product.
4. German Pool will, at its discretion, repair or replace any defective part.
5. This warranty will be void if there is any transfer of ownership from the original purchaser.

客戶服務及維修中心

中國香港

九龍大業街59號

三湘九龍灣貨運中心地下B室

電話：+852 2773 2888

傳真：+852 2356 9798

電郵：repairs@germanpool.com

中國澳門

澳門青州大馬路(青州新路)

515號美居廣場第二期1樓A座

電話：+853 2875 2699

傳真：+853 2875 2661

Customer Service & Repair Centre

Hong Kong, China

Unit B, G/F, Sunshine Kowloon Bay

Cargo Centre, 59 Tai Yip Street, Kowloon

Kowloon, Hong Kong

Tel : +852 2773 2888

Fax : +852 2356 9798

Email : repairs@germanpool.com

Macau, China

A, 1. Andar, Mei Kui Kuong Cheong Fase 2,

No.515 Avenida Do Conselheiro Borja

Macau

Tel : +853 2875 2699

Fax : +853 2875 2661

此保用只適用於香港及澳門

This warranty is valid only in Hong Kong and Macau

German Pool (Hong Kong) Limited

Hong Kong, China

Room 113, Newport Centre Phase II, 116 Ma Tau
Kok Road, Tokwawan, Kowloon, Hong Kong.
Tel: +852 2773 2888
Fax: +852 2765 8215

Mainland China

8th, Xinxiang Road, Wusha Industrial Park,
Daliang, Shunde, Foshan, Guangdong
Tel: +86 757 2219 6888
Fax: +86 757 2219 6809

Macau, China

A, 1 Andar, Mei Kui Kuong Cheong Fase 2,
No.515 Avenida Do Conselheiro Borja, Macau
Tel: +853 2875 2699
Fax: +853 2875 2661



香港 (S MARK)
安全認證



中國櫥櫃/家電行業
十大影響力品牌



CEO非凡品牌大賞



香港優質商標



香港工商業獎



2007
最具潛質
創星品牌企業獎



香港中小企業
最佳成績大獎



香港消費者推崇品牌



香港《心博》
優質服務證書



香港名牌十年成就獎
HONG KONG TOP BRAND TEN YEAR
ACHIEVEMENT AWARD

©All rights reserved. Copying, reproducing or using the contents of this manual is not allowed without prior authorization from German Pool, violators will be prosecuted.