

WiFi Smart UVC Plasma Air Purifier Fan

BEF-351DC-SC



Online Warranty Registration



Please read these instructions and warranty information carefully before use and keep them handy for future reference.

USER MANUAL

請即進行保用登記！

有關保用條款細則，請看說明書最後一頁。

Please register your warranty information now !

For Warranty Terms & Conditions,
please refer to the last page of this user manual.

Tables of Contents

Warnings & Safety Instructions 4

Product Structure 6

Installation Instructions 7

Operation Instructions 10

Cleaning & Maintenance 23

Troubleshooting 24

Technical Specification 24

Warranty Terms & Conditions 47

Warnings & Safety Instructions

WARNING!

Read all instructions carefully before using this product.

- This product is for domestic indoor use only. If this product is used for any commercial, industrial, rental or other purposes, product warranty will be VOIDED.
- This product is not intended for use by children or persons with reduced physical, sensory or mental capabilities, or lack of experience and knowledge, unless they have been given supervision or instruction concerning use of this product by an adult responsible for their safety.
- Mind your children and DO NOT let children play with this product.
- Cleaning and user maintenance shall not be made by children without supervision.
- Check the voltage indicated on the rating label before using this product.
- If the supply cord is damaged, it must be replaced by the manufacturer, its service agent or similarly qualified persons in order to avoid hazards.
- Unplug this product from the power source before cleaning and maintenance.
- Contact German Pool authorized service technician for repair or maintenance of this product.

1.  **WARNING!** To avoid fire, electric shock and bodily harm, user must abide by the following requirements; and abide by your local electrical regulations.
2. Children, the elderly and persons with reduced physical, sensory or mental capabilities, or lack of experience and knowledge, must use this product under supervision and guidance; children must be supervised when touching this product to ensure they DO NOT treat this product as a toy.
3. Before plugging this product in the socket outlet, check to make sure the rated voltage matches the voltage in your home. DO NOT share socket with another appliance, and DO NOT use this product with a universal adaptor.
4. If this product malfunctions, remove from the power source immediately and contact German Pool Customer Service & Repair Centre.
5. DO NOT move this product with power on. When unplugging from the socket, always grasp and pull on the plug, DO NOT pull on the power cord.
6. If the power adaptor is damaged, contact German Pool Customer Service & Repair Centre for replacement. DO NOT replace with other adaptors.
7. DO NOT pull or stretch the power cord, and keep the cord away from hot surfaces.
8. DO NOT place the power cord underneath the carpet, or allow the cord to be covered by rugs, other devices or similar materials. Place the cord away from traffic zones where it may cause people walking by to be tripped over by it.
9. Make sure the product is turned off before unplugging it from the socket.
10. If this product will not be used for an extended period of time, unplug it from the socket and bundle up the power cord to prevent people tripping over it.
11. DO NOT place any object into the air inlet or air outlet. Make sure the air vents are not blocked by objects, and regularly clear away dust, hair or other substances which may hinder air flow.

Warnings & Safety Instructions

12. Place this product far away from heat sources and corrosive gases, in a well-ventilated and horizontal surface with at least 150mm empty space all around this product to ensure proper air ventilation.
13. This product is only suitable for use in a dry environment. DO NOT use outdoors or on a humid surface.
14. To avoid danger, DO NOT immerse this product, its power cord or power plug in water or other liquids. DO NOT use this product with any extension cord unless inspected and approved by a professional technician.
15. DO NOT use air purifiers or similar products next to this product, and DO NOT use any cleaners or lubricants on this product. Always unplug this product from the socket before cleaning and maintenance.
16. DO NOT wash the filter with water.
17. Do not ingest battery, Chemical Burn Hazard.
18. ⚠ **WARNING!** This product contains a coin / button cell battery. If the coin / button cell battery is swallowed, it can cause severe internal burns in just 2 hours and can lead to death.
19. Keep new and used batteries away from children.
20. If the battery compartment does not close securely, stop using the remote control and keep it away from children.
21. If you think batteries might have been swallowed or placed inside any part of the body, seek immediate medical attention.
22. The batteries contain materials which are hazardous to the environment; they must be removed from this product before it is scrapped and that they are disposed of safely.

Product Structure

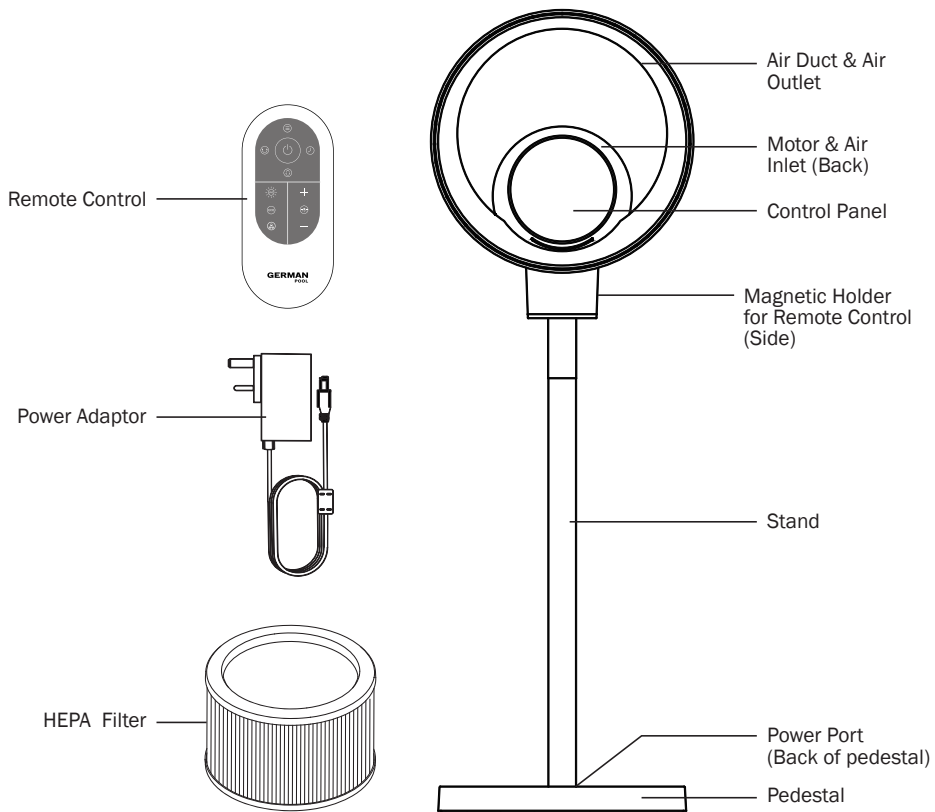

Installation Instructions

Before using this product, remove all packing materials and follow the installation instructions below.

Installing The Body

1. Install the air duct onto the motor **a**.
2. Insert the supplied screw (included in the box) into the screw hole at the bottom of the air duct **b**, and use the screwdriver end of the supplied wrench to tighten the screw in a clockwise motion **c**.
3. Insert the stand into the base of the motor **d**, and tighten the stand in a clockwise motion **e**.
4. Insert the lower end of the stand into the slot on the pedestal **f**. Insert the supplied bolt **g** and use the hex key end of the supplied wrench to tighten the bolt in a clockwise motion **h**.
5. Check that all parts are properly installed. Installation is complete.

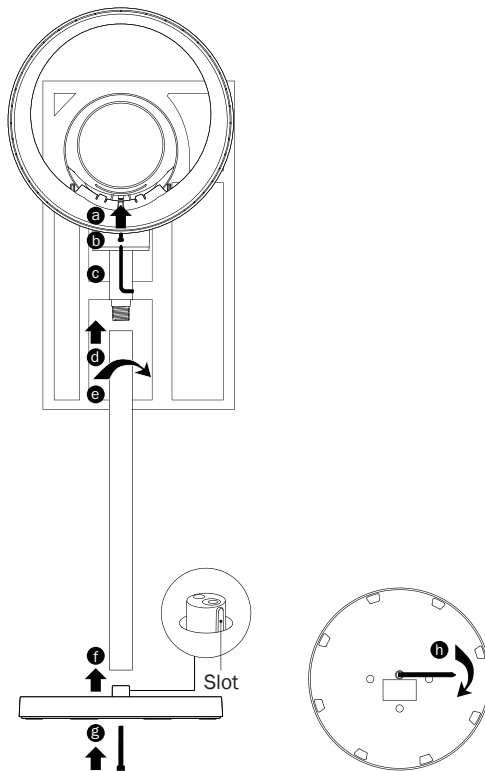

Tighten the bolt on the bottom of the pedestal

Installation Instructions

Installing The Filter

This product is equipped with a HEPA filter. Install the HEPA filter into the motor before using this product.

1. Hold the filter cover at the back of the motor, and turn it anticlockwise to remove it.
2. Remove the HEPA filter from its wrappings and insert it into the motor.
3. Place the filter cover back on, and turn it clockwise to tighten it.

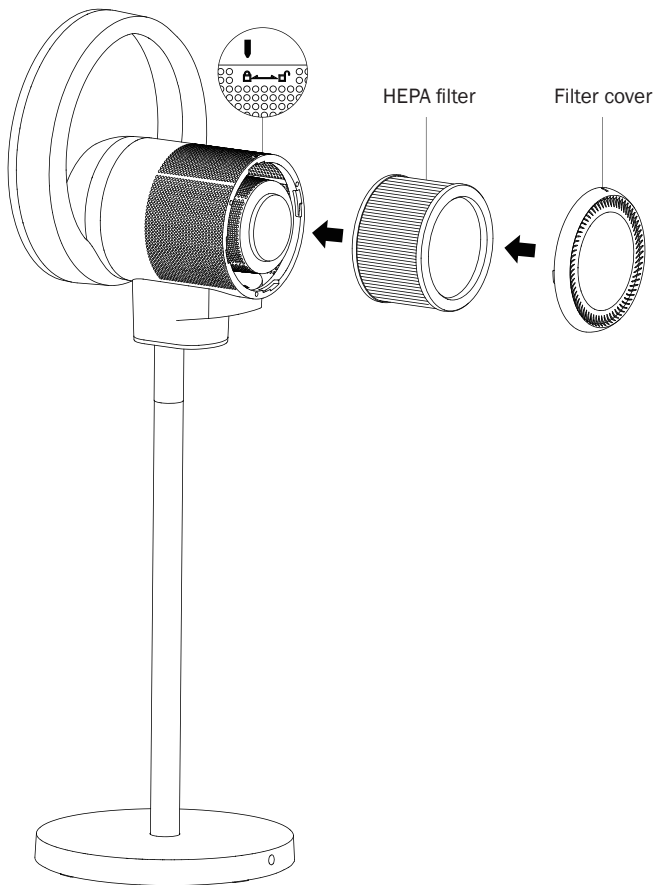

Installation Instructions

Location

- Place this product on a level surface. DO NOT put it on an unstable surface (such as a slanted or soft surface) to avoid it from falling over and getting damaged. DO NOT use this product in hot and humid areas (such as bathroom and kitchen).
- DO NOT block the air inlet when product is in use. Keep the product far away from curtains, so that they will not block the air Inlet and obstruct the product from working properly.
- DO NOT place objects within 1 meter of the air outlet to ensure the air flow would not be reduced.

Installing Remote Control Battery

1. To open the battery cover at the bottom of the Remote Control, press the buckle on the battery cover inward and pull it out.
2. Identify the polarity of the battery, and insert the battery into the battery slot.
3. Reinsert the battery cover into the bottom of the Remote Control.

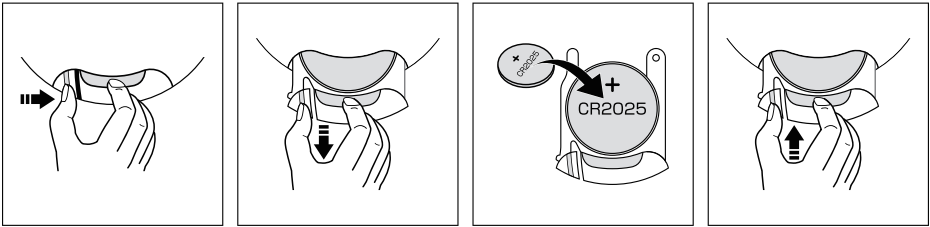

⚠ WARNING!

- This product contains a coin / button cell battery. If the coin / button cell battery is swallowed, it can cause severe internal burns in just 2 hours and can lead to death. Keep new and used batteries away from children.
- This battery is not rechargeable. DO NOT recharge the battery.
- If Remote Control will not be used for a prolonged period of time, please remove the battery.

Operation Instructions

Main Body

Connecting The Power

1. Plug the power cord into the power port located on the pedestal.
2. Connect to the power source. Buzzer beeps once, On/Off Key  lights up, and product enters standby state.

Air Duct Angle Setting

Before adjusting the air duct angle, please make sure the product is turned off. Hold the stand with one hand, and set the air duct 15° forward or backward with the other hand.

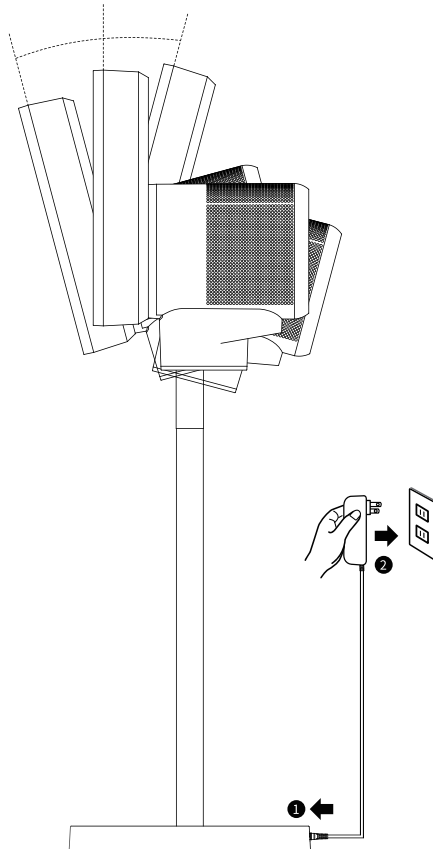





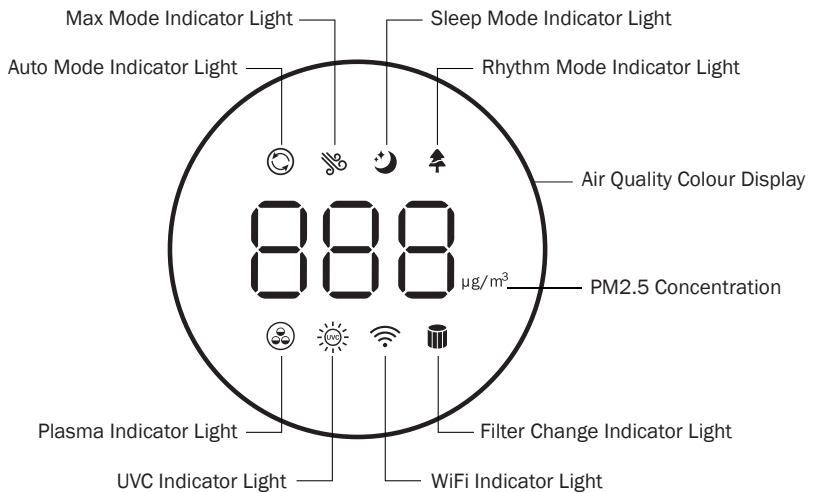





Operation Instructions

Control Panel



Operation Instructions

Control Keys

Key	Function															
 On/Off Key	<ul style="list-style-type: none"> In standby state, tap this key to turn on the product When product is turned on, tap this key to turn off product and return to standby state Tap and hold this key for 5 seconds to start WiFi pairing; WiFi Indicator Light blinks 															
 Mode Key	<ul style="list-style-type: none"> Tap this key to cycle among Auto Mode/Max Mode/Sleep Mode/Rhythm Mode/Manual Mode: In Auto Mode,  Indicator Light lights up constant, product detects PM2.5 concentration in the air and automatically adjusts to its corresponding fan speed level; Air Quality Colour Display will adjust accordingly as well <table border="1" data-bbox="319 622 991 805"> <tbody> <tr> <td>PM2.5 Concentration</td> <td>0-35$\mu\text{g}/\text{m}^3$</td> <td>36-70$\mu\text{g}/\text{m}^3$</td> <td>71-120$\mu\text{g}/\text{m}^3$</td> <td>121-999$\mu\text{g}/\text{m}^3$</td> </tr> <tr> <td>Fan Speed Level</td> <td>004</td> <td>006</td> <td>008</td> <td>010</td> </tr> <tr> <td>LED Display Color</td> <td>Green</td> <td>Yellow</td> <td>Orange</td> <td>Red</td> </tr> </tbody> </table> <ul style="list-style-type: none"> In Max Mode,  Indicator Light lights up constant, fan speed level automatically jumps to Max In Sleep Mode,  Indicator Light lights up constant, fan speed level automatically jumps to lowest, Display Panel goes dim In Rhythm Mode,  Indicator Light lights up constant, fan speed level automatically adjusts to mimic natural breeze In Manual Mode, tap Fan Speed Key  to adjust fan speed level 	PM2.5 Concentration	0-35 $\mu\text{g}/\text{m}^3$	36-70 $\mu\text{g}/\text{m}^3$	71-120 $\mu\text{g}/\text{m}^3$	121-999 $\mu\text{g}/\text{m}^3$	Fan Speed Level	004	006	008	010	LED Display Color	Green	Yellow	Orange	Red
PM2.5 Concentration	0-35 $\mu\text{g}/\text{m}^3$	36-70 $\mu\text{g}/\text{m}^3$	71-120 $\mu\text{g}/\text{m}^3$	121-999 $\mu\text{g}/\text{m}^3$												
Fan Speed Level	004	006	008	010												
LED Display Color	Green	Yellow	Orange	Red												
 Timer Key	<ul style="list-style-type: none"> Tap this key to set 1-8 hr countdown for product to turn off; set timer to "0" to cancel the timer If user manually turns off the product, timer will be automatically cancelled 															
 Oscillation Key	Tap this key to cycle among oscillation angle of 30°/60°/90°/120°/stop oscillation, Display Panel shows "030/060/090/120/current fan speed", 5 seconds later returns to showing current PM2.5 concentration															
 Fan Speed Key	<ul style="list-style-type: none"> Tap this key to cycle among fan speed level 001-010 Tap and hold this key for 2 seconds to activate Max Mode, fan speed level will automatically jump to Max After adjusting fan speed, Display Panel will show current fan speed for 5 seconds, then return to showing current PM2.5 concentration 															

Note:

In Auto Mode/Max Mode/Sleep Mode/Rhythm Mode, tapping Fan Speed Key  will exit the respective mode.

Operation Instructions

Remote Control

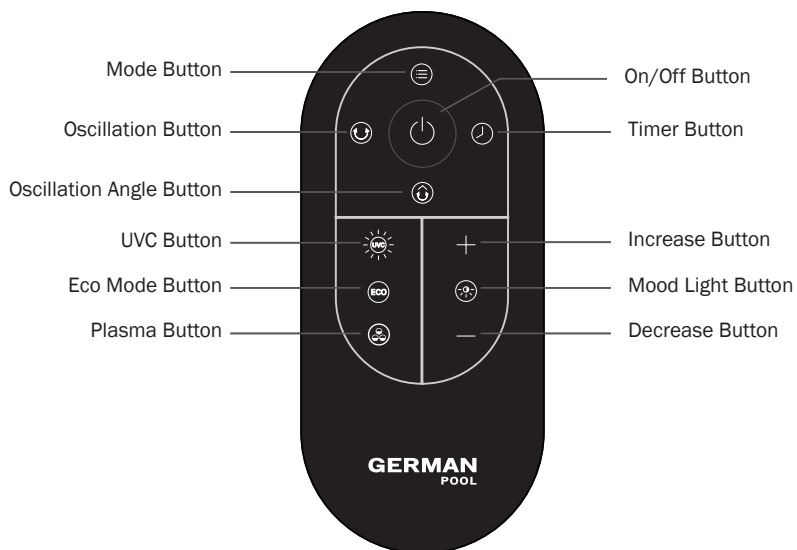











Note:

1. Point the Remote Control directly at the Control Panel to maximize remote control reception.
2. Other products may respond to this Remote Control. This is due to overlapping frequencies of the remote controls. There is no quality problem in the product itself. To avoid interference, keep this Remote Control away from other electrical devices during operation.
3. The On/Off button on the Remote Control does not completely disconnect the power supply to this product. If product will be unused for a prolonged period of time, please unplug the power cord from the socket.

Operation Instructions

Remote Control Buttons

Button	Function
 On/Off Button	<ul style="list-style-type: none"> Press this button to turn product on or off (return to standby state) When Filter Change Indicator Light lights up, it signals the filter needs to be changed. After changing the filter, long-press this button for 5 seconds to reset the cumulative time to zero, Filter Change Indicator Light goes dark (refer to “Cleaning & Maintenance” section for details)
 Timer Button	<ul style="list-style-type: none"> Press this button to set the product to turn off in 1-8 hours; set timer to “0” to cancel the timer When product is manually turned off, timer will automatically be cancelled
 Increase/Decrease Button	<ul style="list-style-type: none"> Press Increase Button to go up one fan speed level; press Decrease Button to go down one fan speed level After adjusting fan speed, Display Panel will show current fan speed for 5 seconds, then return to showing current PM2.5 concentration
 Mood Light Button	Press this button to turn mood light on or off
 Mode Button	<ul style="list-style-type: none"> Press this button to cycle among Auto Mode/Max Mode/Sleep Mode/Rhythm Mode/Manual Mode Refer to “Control Keys” section for details
 Oscillation Button	Press this button to start or stop Oscillation Function, product is set to 90° by default (oscillation angle cannot be adjusted by pressing this button)
 Oscillation Angle Button	When Oscillation Function is turned on, press this button to cycle oscillation angle among 30°/60°/90°/120°, Display Panel shows “030/060/090/120” for 5 seconds, then returns to showing current PM2.5 concentration
 UVC Button	<ul style="list-style-type: none"> Press this button to turn UVC Sterilization Lamp on or off UVC Sterilization Lamp will automatically turn off after it’s been turned on for 1 hour
 Eco Mode Button	<ul style="list-style-type: none"> Press this button to turn lights of control keys and brand logo on or off When Eco Mode is turned on, press any key to exit Eco Mode, lights of control keys and brand logo will light up
 Plasma Button	Press this button to turn Plasma Function on or off

Note:

In Auto Mode/Max Mode/Sleep Mode/Rhythm Mode, pressing Increase Button/Decrease Button will exit the respective mode.

Operation Instructions

Connecting The Product To WiFi

This product can be controlled via smartphone with German Pool Smart Control APP.

Note:

To connect the product to WiFi, please use WiFi with a frequency of 2.4 GHz, does not work with WiFi with a frequency of 5.0 GHz.

A. How To Set Up The APP

1. Connect your phone to 2.4 GHz WiFi then scan the QR Code below, or search "German Pool Smart Control" in App Store or Google Play to download and install the APP.



Apple IOS System
App Store



Android System
Google Play

B. Change The Language

Apple IOS System

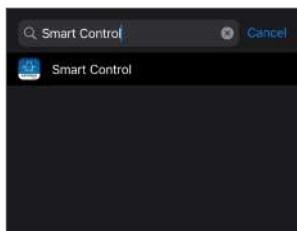

1. Search "Smart Control" in Settings.

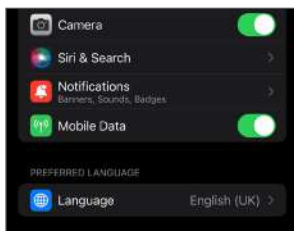

2. Click "Preferred Language".



3. Select Traditional Chinese or English in the "Suggested Languages" column (Note: if user select "Traditional Chinese (Hong Kong)", app will display in English).

Android System

App will appear in your preset phone language. If you need to change APP language, you need to change the system language in your phone settings.

Operation Instructions

C. Register Your Account

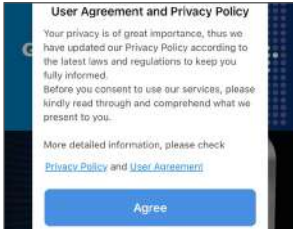

1. Open the APP , click “Agree” on “User Agreement and Privacy Policy”.



2. Click “Sign Up” to register your account.



3. Enter your email address, tick “I agree Privacy Policy and User Agreement”, then click “Get Verification Code”.

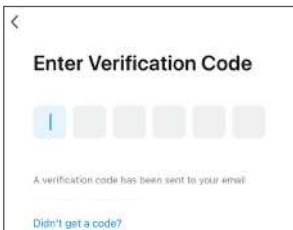

4. Enter one-time verification code from your email.



5. Set up your password then click “Done”.

Operation Instructions

D. Pairing Sequence

Method 1: Auto Pairing



1. Long-press the product's On/Off Key for 5 seconds until WiFi Indicator Light blinks.



2. Click "+" on the upper right corner of the APP homepage, then click "Add Device".



3. Before pairing, user must allow the App to access your Bluetooth. Tap on "Turn on Bluetooth" (if Bluetooth is already on, ignore this step).

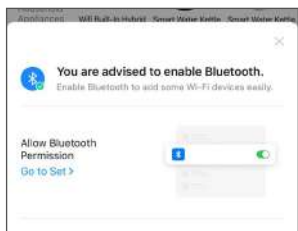

4. Tap "Go To Set" (if Bluetooth is already on, ignore this step).

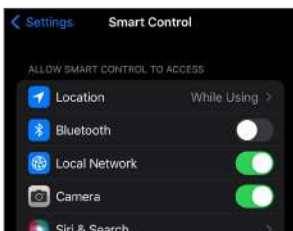

5. Turn on Bluetooth (if Bluetooth is already on, ignore this step).



6. APP will show "Searching for nearby devices...".

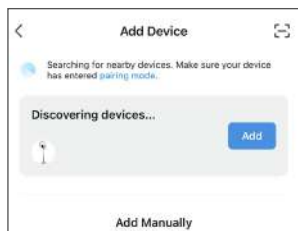

7. APP will show "Discovering devices...", click "Add".



8. Click "+" on the right of product name.

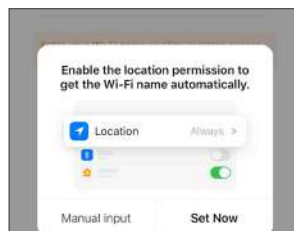

9. it is recommended to allow the APP to access your location. Tap "Set Now" (if Location is already on, ignore this step).

Operation Instructions

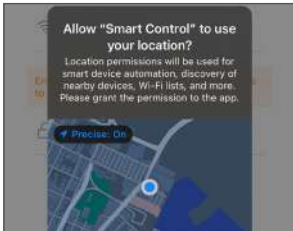

10. Tap “Allow While Using App” (if Location is already on, ignore this step).

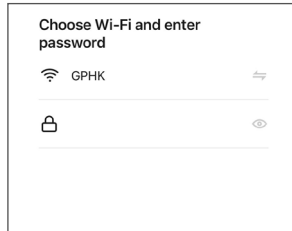

11. Select WiFi name and enter your WiFi password, then click “Next”.

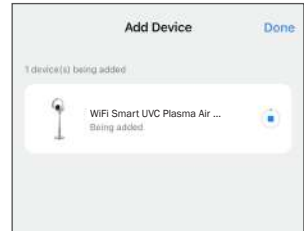

12. APP will show “Being Added”, the product and APP will automatically pair up.

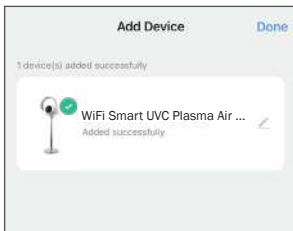

13. When pairing is completed, APP will show “Added successfully”. Click “Done” to return to homepage.

⚠ WARNING!

If Bluetooth is turned off or App is not permitted to access Bluetooth, the product cannot be paired. (Note: Even if Bluetooth is turned on, it does not mean the APP is allowed to access your Bluetooth.)

Note:

- The product can only be paired to one account at a time. If another user pairs their smartphone to the product, the previous account will lose their control of the product.
- User who has already been paired can share their control rights with other users. For details, see “E. Sharing Control”.

Note:

If APP cannot find the product, or during Pairing Sequence, if APP shows an exclamation mark icon, it means pairing is unsuccessful. Please use method 2 below for pairing.

Operation Instructions

Method 2: Bluetooth Pairing



1. Click “+” on the upper right corner of the APP homepage, then click “Add Device”.

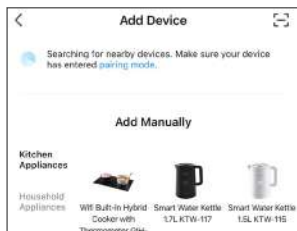

2. In the “Add Manually “ column, find the product model that needs to be paired, and click the product to pair.



3. Follow the instructions on the APP to pair.

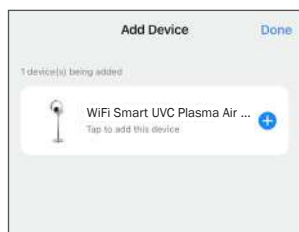

4. Click “+” on the right of product name.

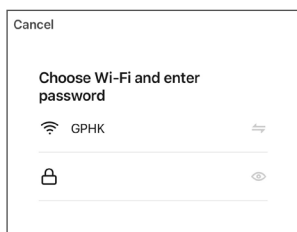

5. Select WiFi name and enter your WiFi password, then click “Next”.

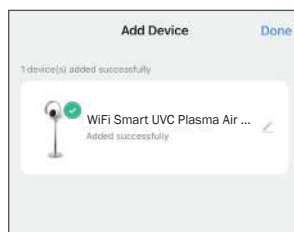

6. When pairing is completed, APP will show “Added successfully”. Click “Done” to return to homepage.

⚠ WARNING!

If Bluetooth is turned off or App is not permitted to access Bluetooth, the product cannot be paired. (Note: Even if Bluetooth is turned on, it does not mean the APP is allowed to access your Bluetooth.)

Operation Instructions

E. Sharing Control

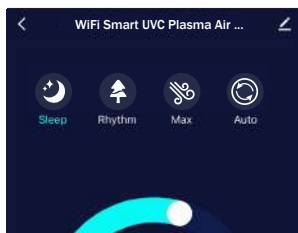

1. On the product's homepage, click “” on the upper right corner.

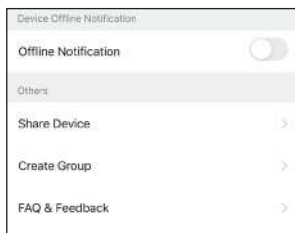

2. Click “Share Device” under “Others”.

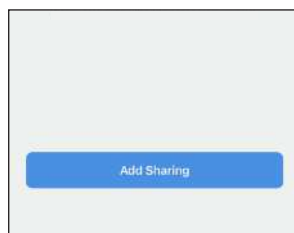

3. Click “Add Sharing”.



4. Set the number of users with whom you wish to share control, then click “Share with the Account Smart Control”.



5. Enter that account's registered email address, then click “Done” on the upper right corner.



6. Repeat step 3-5 to share with more accounts.

Note:





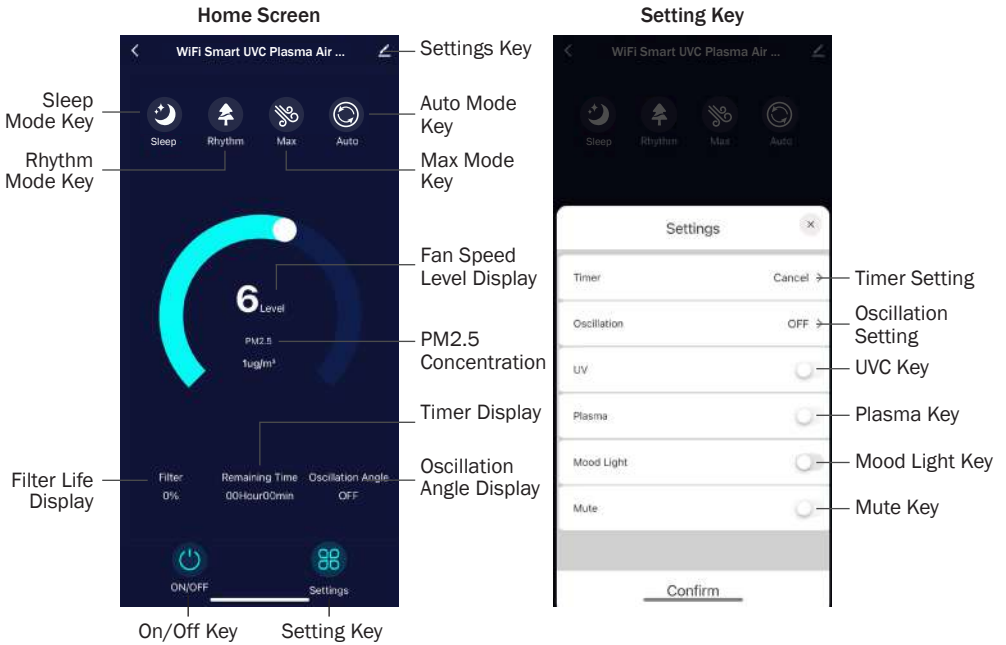

On the “Share Device” page, you can add or delete other accounts' control rights.

Operation Instructions

Controlling The Product With The APP



Operation Instructions

Key		Description
	Sleep Mode Key	Tap this key to select Sleep Mode
	Rhythm Mode Key	Tap this key to select Rhythm Mode
	Max Mode Key	Tap this key to select Max Mode
	Auto Mode Key	Tap this key to select Auto Mode
	Fan Speed Level Radial Slider	Tap and slide to adjust fan speed level (001-010)
	On/Off Key	Tap this key to turn product on or off (return to standby state)
Timer Setting		Tap this key to set the product to turn off in 1-8 hours, or cancel the timer
Oscillation Setting		Tap this key to adjust oscillation angle among 30°/60°/90°/120°/stop oscillation
UVC Key		Tap this key to turn UVC Sterilization Lamp on or off
Plasma Key		Tap this key to turn Plasma Function on or off
Mood Light Key		Press this button to turn mood light on or off
Mute Key		Tap this key to turn sound on or off

Cleaning & Maintenance

⚠ WARNING!

- Turn off the product and unplug from the power source before cleaning and maintenance.
- DO NOT immerse or wash the HEPA filter with water.
- DO NOT use or store this product or the HEPA filter in a humid environment to avoid reducing the filter's efficiency.

Changing The Filter

After a total of 720 hours of operation, Filter Change Indicator Light will light up, indicating the filter needs to be changed. After installing a new filter, long-press On/Off Key on the Remote Control for 5 seconds, Filter Change Indicator Light goes dark, and product will enter a new 720 hour cycle.

Cleaning The Product Surface

- DO NOT splash water on the product or allow product to get wet, in order to avoid liquid entering and damaging the motor.
- DO NOT use benzine, gasoline, alcohol, bleach or metal object to clean the surface of the product, as it may cause discoloration or damage to the casing.
- Use a soft dry cloth to lightly wipe the product surface; if the surface is particularly dirty, wipe it gently with a soft cloth moistened with diluted neutral cleanser, then dry off with a soft dry cloth.

Air Inlet / Air Outlet

Use a soft brush or vacuum cleaner to clean off dust accumulated on the air inlet and outlet; DO NOT allow heavy dust to accumulate on the vents as it will reduce the product's efficiency.

Remote Control

Use a soft dry cloth to lightly wipe the remote control's surface. If the remote control will not be used in an extended period of time, please remove the batteries to avoid battery drainage.

Power Plug

Use a soft dry cloth to wipe off any accumulated dust.

Troubleshooting

Problem	Possible Cause	Solution
Product does not turn on	Power cord is not plugged in properly	Plug in the power cord properly
	Product is damaged	Contact German Pool Customer Service & Repair Centre
Product cannot turn off	Product is damaged	Contact German Pool Customer Service & Repair Centre
Remote Control doesn't respond	Battery is dead or the polarity is reversed	Replace batteries and make sure the polarity is correct
	Remote control is not aimed directly at the signal receptor	Aim remote control directly at the Control Panel

Technical Specification

Model	BEF-351DC-SC
Power	35 W
Voltage	24V DC
Frequency	50/60 Hz
Product Dimensions	(H) 1162 (W) 380 (D) 358.5 mm
Net Weight	7 kg

- Specifications are subject to change without prior notice.
- If there is any inconsistency or ambiguity between the English version and the Chinese version, the Chinese version shall prevail.
- Refer to www.germanpool.com for the most up-to-date version of the Operating Instructions.

目錄

警告及注意事項	26
產品結構	28
安裝說明	29
使用說明	32
清潔及保養	45
故障檢修	46
技術規格	46
保用條款	47

警告及注意事項

⚠ 警告！

使用本產品前，請仔細閱讀所有說明。

- 本產品只限家居室內日常使用，如產品作任何商業、工業、出租或其他用途，保用證即告失效。
- 請勿讓兒童或身體有殘障、精神不健全及對本產品缺乏經驗或知識的人士單獨使用本產品；如需使用，必須要在負責任的成年人監管下方可使用。
- 應照顧好兒童，確保他們不會玩弄本產品。
- 無成年人監管下，勿讓兒童清潔及維護本產品。
- 使用前，請先檢查所有電壓是否與本產品標籤上的電壓相符。
- 如果電源線損壞，為免發生意外，電源線必須由廠方、廠方指定的維修中心或同等合格的技術人員進行更換。
- 清潔或檢查本產品前，必須先關機及拔掉插頭。
- 請聯繫德國寶授權的技術人員進行維修或保養本產品。

1. ⚠ 警告！為避免火災、電擊、人身傷害，必須遵守以下要求；其他必須遵循所在地方的有關電氣法規。
2. 兒童、老年或殘障人士以及沒有使用經驗的人必須在監護和指導下使用本產品，小孩必須在監管下接觸本產品以確保他們不會把本產品當成玩具。
3. 必須單獨使用與本產品電流一致的插座，嚴禁用萬用插座與其他電器同時使用。
4. 如本產品不運作，維修時必須切斷電源並由專業人員維修。
5. 嚴禁帶電移動本產品，插拔電源插頭時，必須用手持插頭，嚴禁拉扯電源線。
6. 如電源換轉器損壞，請聯絡德國寶客戶服務及維修中心，嚴禁自行更換。
7. 嚴禁拉伸或拉緊電源線，保持電源線遠離過熱的表面。
8. 電源線嚴禁擺放在地毯下，不能被小地毯、其他裝置或類似材料覆蓋，電源線應遠離交通區，放置在不會被絆倒的區域。
9. 插頭拔出前必須關閉所有的操作裝置。
10. 長時間不用本產品時，拔離插座，為避免絆倒危險，必須安全收好電源線。
11. 嚴禁把任何物體放在進風口或出風口處，確保風口暢通，保持無灰塵、皮棉、頭髮和任何可能減少氣流的障礙。
12. 本產品應放置在遠離熱源、周圍無腐蝕性氣體，通風良好乾燥的無傾斜平面上，本產品周圍必須留有150mm的空間，以保證空氣流動。
13. 本產品只適合放在乾燥的地方使用，不能在室外或潮濕的表面使用。
14. 嚴禁將本產品、電源線、電源插頭浸入水中或其他液體中，以免發生危險，非專業人員檢測，嚴禁使用其他外延電源線。
15. 嚴禁直接將空氣清新機或類似產品放在本產品旁邊使用，嚴禁對本產品使用任何清潔劑或潤滑劑，清洗或進行任何維修前必須拔除插頭。
16. 嚴禁使用水直接清洗過濾網。
17. 不要攝入電池，可能導致化學灼傷危險。

警告及注意事項

18. ⚠ **警告！**本產品包含鈕扣電池。如果鈕扣電池被吞下，可能在2小時內造成嚴重的內部燒傷，並可能導致死亡。
19. 新電池和舊電池應遠離兒童。
20. 如果電池蓋不能安全關閉，請停止使用遙控器，並將其遠離兒童。
21. 如果您認為電池可能被吞食或放置在身體任何部位，請立即就醫。
22. 電池含有對環境有害的材料；在報廢前，必須將其從設備中取出，並進行安全處理。

產品結構

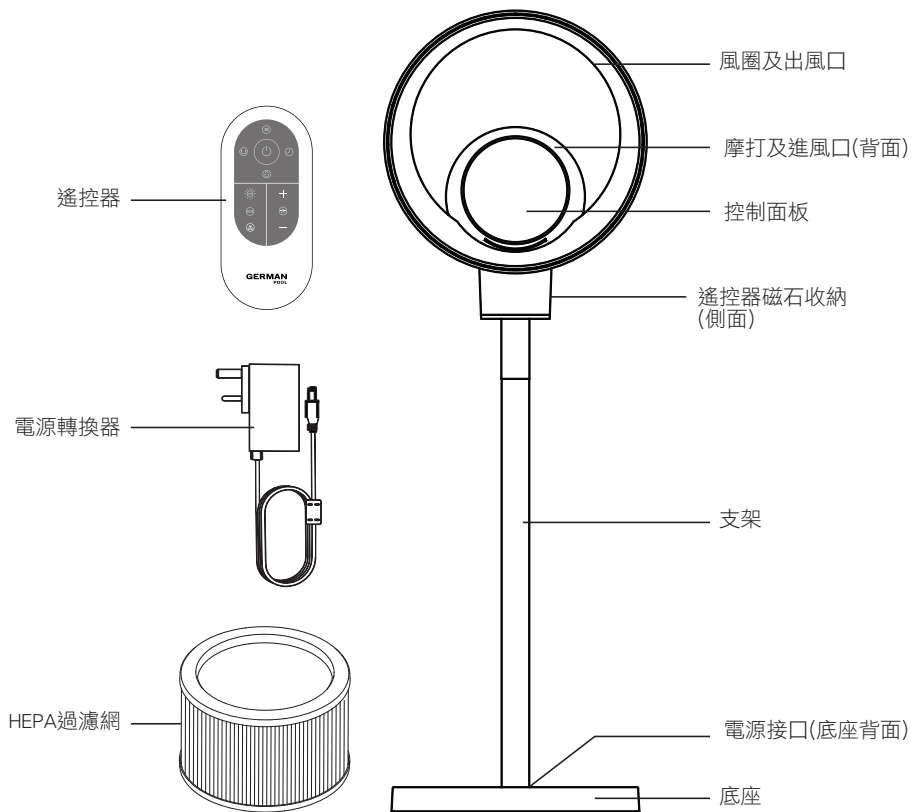

安裝說明

首次使用前，請先拆除所有包裝物，然後按以下說明進行安裝。

安裝機身

1. 將風圈安裝至摩打上 **a**。
2. 將跟機附送的螺絲插入風圈底部的螺絲孔 **b**，使用跟機附送的專用扳手順時針擰緊螺絲 **c**。
3. 將支架插入摩打底部 **d**，順時針旋轉支架鎖緊 **e**。
4. 將支架下端插入底座上的卡槽 **f**，將跟機附送的螺栓插入底座底部的孔位 **g**，再使用專用扳手順時針擰緊底座螺栓 **h**。
5. 檢查本產品各部份是否穩妥，安裝完成。

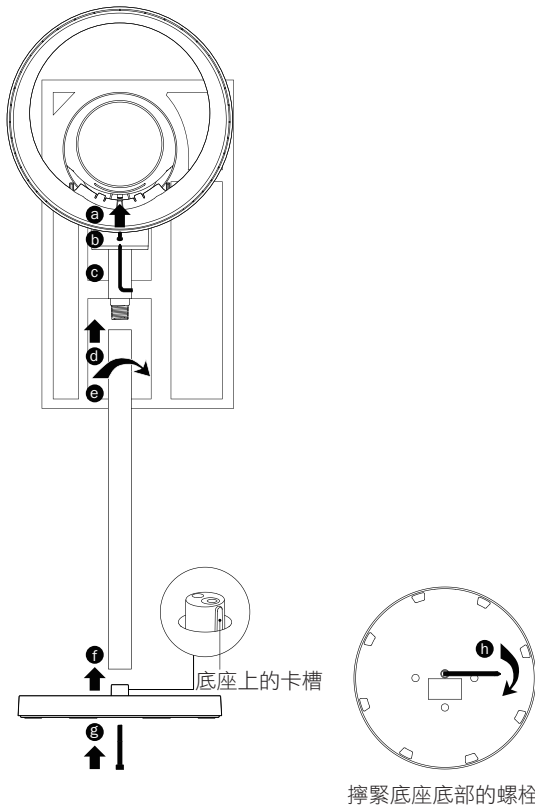

安裝說明

安裝過濾網

本產品配備HEPA過濾網，使用前必須先將HEPA過濾網安裝到摩打內部。

1. 逆時針旋轉並拆下摩打背部的濾網蓋。
2. 將HEPA過濾網拆除包裝袋後，放入摩打內部。
3. 將濾網蓋裝回摩打背部，順時針旋轉鎖緊。

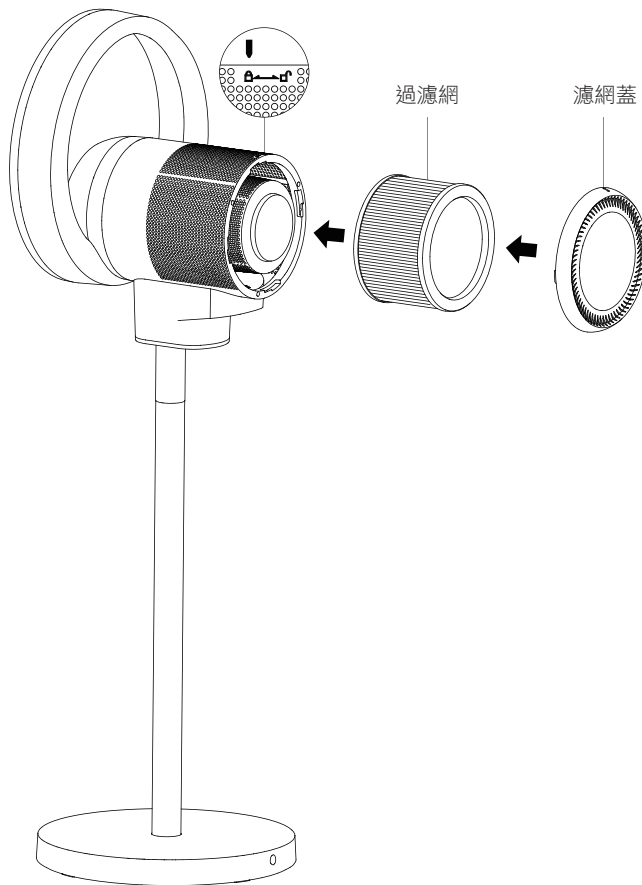

安裝說明

安裝位置

- 將本產品放置在水平位置使用，嚴禁放置在不穩定地方（如有斜度、柔軟的表面），以避免本產品翻倒造成損壞或故障；嚴禁在高溫潮濕的地方使用本產品（如浴室、廚房）。
- 在使用過程中，嚴禁擋住進風口，必須遠離裝有窗簾的地方使用，以避免物體堵住進風口導致本產品無法運作。
- 出風口前面1米內嚴禁放置任何物體以防減弱吹風效果。

安裝遙控器電池

1. 向內按住遙控器底部電池槽上的扣位，電池槽往外拉出。
2. 確認電池的極性，將電池裝進電池槽的凹槽內。
3. 將電池槽裝回遙控器的底部。

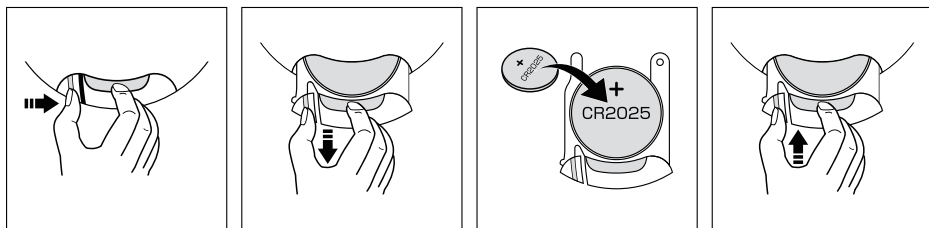

⚠ 警告!

- 本產品包含鈕扣電池。如果鈕扣電池被吞下，可能在2小時內造成嚴重的內部燒傷，並可能導致死亡。新電池和舊電池應遠離兒童。
- 此電池不能充電。嚴禁為本產品電池充電。
- 如果長時間不使用遙控器，請取出電池。

使用說明

主機操作方法

接通電源

1. 將電源線連接至底座的電源接口。
2. 接通電源後，蜂鳴器發出提示聲1聲，開關鍵  亮著，產品進入待機狀態。

風圈角度調整

運行停止後，朝向喜歡的方向擺動；請單手握住支架，另一隻手對風圈角度進行前後各15°調節。

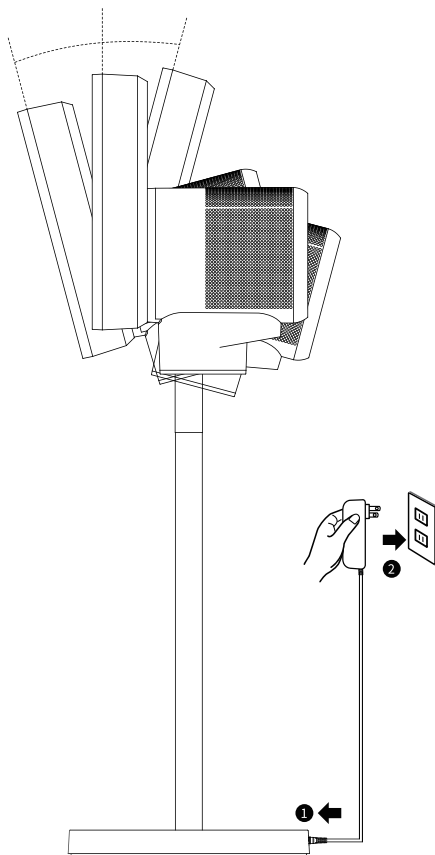





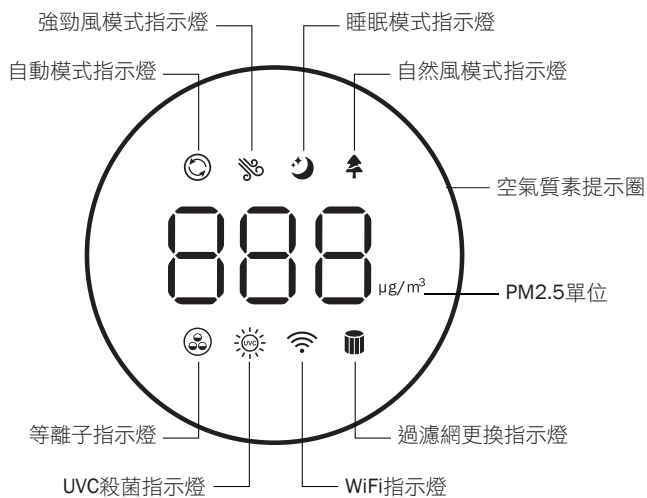





使用說明

控制面板



使用說明

控制面板按鍵說明

按鍵	說明															
 開關鍵	<ul style="list-style-type: none"> 當產品處於待機狀態下按此鍵，產品開始運行 當產品處於運行狀態下按此鍵，停止運行並返回待機狀態 長按此鍵5秒進入WiFi連接狀態，WiFi指示燈閃爍 															
 模式鍵	<ul style="list-style-type: none"> 按此鍵循環選擇「自動模式」、「強勁風模式」、「睡眠模式」、「自然風模式」、「手動模式」 自動模式下， 指示燈常亮，根據檢測到的PM2.5數值自動調節至相應風速檔位，顯示屏上的空氣質素提示圈亦會按下表自動變色 <table border="1" data-bbox="319 550 991 734"> <thead> <tr> <th>PM2.5 數值</th> <th>0-35$\mu\text{g}/\text{m}^3$</th> <th>36-70$\mu\text{g}/\text{m}^3$</th> <th>71-120$\mu\text{g}/\text{m}^3$</th> <th>121-999$\mu\text{g}/\text{m}^3$</th> </tr> </thead> <tbody> <tr> <td>風速檔位</td> <td>004</td> <td>006</td> <td>008</td> <td>010</td> </tr> <tr> <td>顯示屏顏色</td> <td>綠色</td> <td>黃色</td> <td>橙色</td> <td>紅色</td> </tr> </tbody> </table> <ul style="list-style-type: none"> 強勁風模式下， 指示燈常亮，風速檔位自動調節至最大 睡眠模式下， 指示燈常亮，風速檔位自動調節至最小，顯示屏變暗 自然風模式下， 指示燈常亮，風速檔位自動調節以模擬自然風 手動模式下，按「風速鍵」調節風速檔位 	PM2.5 數值	0-35 $\mu\text{g}/\text{m}^3$	36-70 $\mu\text{g}/\text{m}^3$	71-120 $\mu\text{g}/\text{m}^3$	121-999 $\mu\text{g}/\text{m}^3$	風速檔位	004	006	008	010	顯示屏顏色	綠色	黃色	橙色	紅色
PM2.5 數值	0-35 $\mu\text{g}/\text{m}^3$	36-70 $\mu\text{g}/\text{m}^3$	71-120 $\mu\text{g}/\text{m}^3$	121-999 $\mu\text{g}/\text{m}^3$												
風速檔位	004	006	008	010												
顯示屏顏色	綠色	黃色	橙色	紅色												
 定時鍵	<ul style="list-style-type: none"> 按此鍵可設置1-8小時定時關機，當定時設置為「0」時即取消定時 當手動進行關機後，定時設置將自動取消 															
 搖擺鍵	按此鍵循環選擇搖擺角度30°/60°/90°/120°/停止搖擺，顯示屏顯示「030/060/090/120/當前風速檔位」，5秒後顯示當前PM2.5數值															
 風速鍵	<ul style="list-style-type: none"> 按此鍵循環選擇001-010風速檔位 長按此鍵2秒進入強勁風模式，風速檔位自動調節至最大 調整風速後，顯示屏顯示當前風速，5秒後顯示當前PM2.5數值 															

注意：

在自動模式、強勁風模式、睡眠模式或自然風模式下按風速鍵，直接退出當前模式。

使用說明

遙控器功能介紹

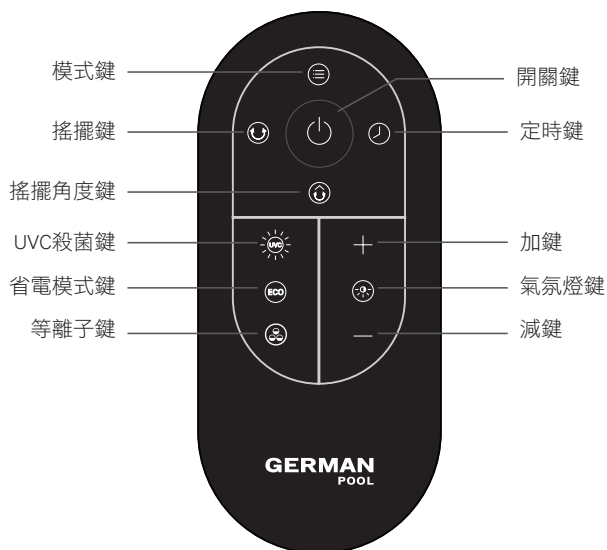

注意：

1. 使用遙控器操作時，需將遙控器對準控制面板，使遙控信號接收達到最好。
2. 使用本產品的遙控器時，其他電器可能會產生反應。這是由於遙控器的頻率產生重疊而發生的現象，產品本身並無品質問題。為了避免誤操作，操作時請將遙控器遠離其他電器。
3. 遙控器的開關鍵不能使本產品電源完全關閉，如長時間不使用本產品，請拔掉電源插頭。

使用說明

遙控器按鍵說明

按鍵	說明
 開關鍵	<ul style="list-style-type: none">按此鍵開機或關機返回待機狀態當過濾網更換指示燈常亮，更換過濾網後長按此鍵5秒將累計時間清零，濾網更換指示燈熄滅（詳見「清潔與保養」）
 定時鍵	<ul style="list-style-type: none">按此鍵可調置1-8小時定時關機，當定時設置為「0」時即取消定時當手動進行關機後，定時設置將自動取消
 加/減鍵	<ul style="list-style-type: none">按加鍵增加風速檔位1檔；按減鍵減少風速檔位1檔調整風速後，顯示屏顯示當前風速檔位，5秒後顯示當前PM2.5數值
 氣氛燈鍵	按此鍵開啟或關閉氣氛燈
 模式鍵	<ul style="list-style-type: none">按此鍵循環選擇「自動模式」、「強勁風模式」、「睡眠模式」、「自然風模式」、「手動模式」功能說明與「控制面板及按鍵說明」相同
 搖擺鍵	按此鍵開啟或關閉搖擺功能，預設為90°（按此鍵無法調整搖擺角度）
 搖擺角度鍵	搖擺功能開啟後，按此鍵循環選擇搖擺角度30°/60°/90°/120°，顯示屏顯示「030/060/090/120」，顯示屏5秒後顯示當前風速檔位，再5秒後顯示當前PM2.5數值
 UVC殺菌鍵	<ul style="list-style-type: none">按此鍵開啟或關閉UVC殺菌燈UVC殺菌燈連續開啟1小時後會自動關閉
 省電模式鍵	<ul style="list-style-type: none">按此鍵熄滅或亮著顯示屏上的按鍵及品牌標誌在省電模式下按任意鍵退出省電模式，按鍵及品牌標誌亮著
 等離子鍵	按此鍵開啟或關閉等離子功能

注意：

在自動模式、強勁風模式、睡眠模式或自然風模式下按加鍵 **+** 或減鍵 **-**，直接退出當前模式。

使用說明

使用WiFi連接本產品

本產品可透過德國寶智能控制應用程式「German Pool Smart Control」APP以智能手機操控。

注意：

必須使用頻率為2.4 GHz的WiFi進行連接，不適用於頻率為5.0 GHz的WiFi。

A. 下載應用程式

連接頻率為2.4 GHz的WiFi後，掃描下方二維碼，或於蘋果iOS系統上的App Store或安卓Android系統上的 Google Play搜尋「German Pool Smart Control」，下載並安裝APP。



蘋果iOS系統
App Store



安卓Android系統
Google Play

B. 設置APP語言

蘋果iOS系統

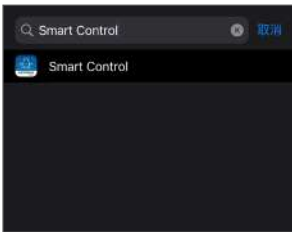

1. 在手機的設定中搜尋「Smart Control」。



2. 點擊「偏好的語言」。



3. 在「建議的語言」一欄中選擇繁體中文或英文（注意：選擇「繁體中文(香港)」APP將會顯示英文）。

安卓Android系統

預設為系統所使用的語言，如需更改APP語言，需在設置中更改系統語言。

使用說明

C. 註冊用戶資料

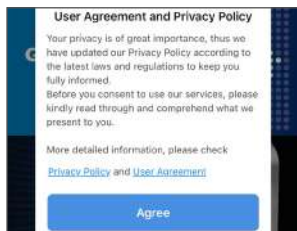

1. 打開APP，點擊「用戶協議與隱私政策」上的「同意」。
2. 點擊「註冊」註冊用戶資料。
3. 輸入電郵地址，剔選「我同意隱私政策與用戶協議」後點擊「獲取驗證碼」。



4. 輸入電郵裡的驗證碼。
5. 設定您的登入密碼後點擊「完成」，完成註冊。

使用說明

D. 配對本產品

方法1：自動配對



1. 長按風扇上的「開關鍵」5秒，直至WiFi指示燈閃爍。



2. 點擊APP主頁右上角「+」，再點擊「添加設備」。



3. 配對前必須先打開藍牙權限，點擊「打開藍牙」（如已打開，可忽略此步驟）。



4. 點擊「去設定」（如已打開，可忽略此步驟）。



5. 點擊藍牙一欄以打開藍牙權限（如已打開，可忽略此步驟）。



6. APP顯示「正在搜索附近的設備...」。



7. 數秒後APP顯示「發現設備...」，點擊「添加」。



8. 點擊產品名稱右方的「+」。



9. 配對時建議開啟位置權限，點擊「立即設置」（如已開啟，可忽略此步驟）。

使用說明



10. 點擊「使用App時允許」（如已開啟，可忽略此步驟）。



11. 輸入手機所連接的WiFi名稱及密碼，點擊「下一步」。



12. APP顯示「正在添加」，產品與APP自動配對中。



13. 配對完成後APP顯示「添加成功」，按右上角「完成」進入產品主界面。

⚠ 警告！

如沒有開啟藍牙或沒有打開藍牙權限，將無法配對產品；注意，即使電話已開啟藍牙功能，並不代表已打開「藍牙權限」。

注意：

- 每次只可以一個帳戶進行配對，如由另一帳戶再次進行配對，先前已配對的帳號將失去本產品的操作權。
- 已配對的帳戶可以分享本產品的操作權予其他帳戶，詳見「E. 操作權分享」部份。

注意：

如無法搜索到本產品，或在配對期間APP顯示感嘆號符號，代表配對失敗，請使用下列的方法2進行配對。

使用說明

方法2：藍牙配對



1. 點擊APP主頁右上角「+」，再點擊「添加設備」。



2. 在「手動添加」一欄找到需要配對的產品型號，點擊該產品進行配對。



3. 按照APP上的指示進行配對。



4. 點擊產品名稱右方的「+」。



5. 輸入手機所連接的WiFi名稱及密碼，點擊「下一步」。



6. 配對完成後APP顯示「添加成功...」，按右上角「完成」進入產品主界面。

⚠ 警告！

如沒有開啟藍牙或沒有打開藍牙權限，將無法配對產品；注意，即使電話已開啟藍牙功能，並不代表已打開「藍牙權限」。

使用說明

E. 操作權分享



1. 在本產品操作主界面點擊右上角「」。



2. 在「其他」一欄中點擊「共用設備」。



3. 點擊下方「添加共用」。



4. 在「分享給其他人」一欄中可設定所需分享的人數，再點擊「分享給 SmartControl 賬號」。



5. 輸入該帳戶的註冊電郵地址，再點擊右上角「完成」即可。



6. 重複步驟3-5添加更多其他帳戶。

注意：







在「共用設備」頁面裡，你可隨時添加或移除帳戶的操作權。

使用說明

使用APP操作



使用說明

按鍵		說明
	睡眠模式鍵	按此鍵選擇睡眠模式
	自然風模式鍵	按此鍵選擇自然風模式
	強勁風模式鍵	按此鍵選擇強勁風模式
	自動模式鍵	按此鍵選擇自動模式
	風速檔位調節欄	滑動調節風速檔位（001-010）
	開關鍵	按此鍵開機或關機返回待機狀態
定時設置		按此可選擇1-8小時定時，或取消定時功能
搖擺角度設置		按此可選擇30° /60° /90° /120° 搖擺角度，或關閉搖擺功能
UVC殺菌鍵		按此鍵開啟或關閉UVC殺菌燈
等離子鍵		按此鍵開啟或關閉等離子功能
氣氛燈鍵		按此鍵開啟或關閉氣氛燈
靜音鍵		按此鍵關閉或開啟蜂鳴器

清潔及保養

⚠ 警告!

- 清潔或保養前，必須先關機及拔下電源插頭。
- 嚴禁水洗HEPA過濾網或將其浸入水中。
- 嚴禁將本產品或HEPA過濾網放在潮濕位置使用，以免影響過濾網效率。

過濾網更換

本產品累計運行720小時後LED顯示屏上的過濾網更換指示燈常亮，表示需要更換過濾網；更換過濾網後長按遙控器「開關鍵」5秒，指示燈熄滅並重新累計時間。

產品表面

- 嚴禁讓產品沾上水或者潑上水，可能會導致機器進水而損壞。
- 嚴禁使用香蕉水、汽油、酒精、漂白劑或者金屬物體擦拭產品表面，可能會導致表面變色、變質。
- 使用乾的軟布輕輕擦拭產品表面；如果表面比較髒，可使用中性洗滌劑稀釋後用濕軟布擦拭；擦拭乾淨後再用乾軟布進行擦拭。

進氣口及出風口

使用軟刷或吸塵器清潔進風口和出風口處的灰塵，集聚太多灰塵的話可能會影響使用效果，請在灰塵較少的時候及時進行清潔。

遙控器

使用乾的軟布輕輕擦拭遙控器表面。如果長時間不使用，避免電池消耗，請取出遙控器內的電池。

電源插頭

使用乾的軟布清潔電源插頭。

故障檢修

故障情況	可能原因	解決方法
無法開機	電源線沒有插上或接觸不良	插上電源保證接觸良好
	機體損壞	聯絡德國寶客戶服務及維修中心
無法關機	機體損壞	聯絡德國寶客戶服務及維修中心
遙控器失靈	電池沒電或電池方向安裝錯誤	更換新電池，確保電池按正確方向重新安裝好
	遙控器沒有對準主機的信號接收器	對準控制面板

技術規格

型號	BEF-351DC-SC
功率	35 W
電壓	24V DC
頻率	50/60 Hz
產品尺寸	(H) 1162 (W) 380 (D) 358.5 mm
淨重	7 kg

產品規格及設計如有變更，恕不另行通知。
中英文版本如有出入，一概以中文版為準。
本產品使用說明書以 www.germanpool.com 網上版為最新版本。

保用條款

此保用提供德國寶產品之機件在正常使用下壹年保用 (自購買日起計算)。

Warranty Terms & Conditions

Under normal operations, the product will guarantee a 1-year full warranty provided by German Pool (effective from the date of purchase).

* 貴戶須在購機十天內，以下列其中一種方式向本公司登記資料，保用手續方正式生效：

- 1) 填妥德國寶VIP手機應用程式保用登記表 (掃描右方二維碼)
- 2) 填妥本公司網頁保用登記表
www.germanpool.com/warranty
- 3) 填妥保用卡郵寄至本公司。



* This warranty is not valid until customer registration information is received by our Service Centre within 10 days of purchase via one of the following means:

- 1) Visit our VIP App and register online:
(Scan the QR Code on the right)
- 2) Visit our website and register online:
www.germanpool.com/warranty
- 3) Complete the attached Warranty Card and mail it back to our Customer Service Centre.



另請填妥以下表格並與正本發票一併保存，以便維修時核對資料。用戶提供之所有資料必須正確無誤，否則免費保用將會無效。 Please fill out the form below. This information and the original purchase invoice will be required for any repairs. Warranty will be invalidated if information provided is found to be inaccurate.

型號 Model No. : BEF-351DC-SC

機身號碼 Serial No. : _____ 發票號碼 Invoice No. : _____

購買商號 Purchased From : _____ 購買日期 Purchase Date : _____

1. 未能出示購買發票正本者，將不獲免費維修服務。
2. 用戶應依照說明書的指示操作。本保用並不包括：
 - 上門安裝、檢驗、維修或更換零件之人工以及一切運輸費用；
 - 因天然與人為意外造成的損壞 (包括運輸及其他)；
 - 電源接合不當、不依說明書而錯誤或疏忽使用本機所引致之損壞。
3. 於下列情況下，用戶之保用資格將被取消：
 - 購買發票有任何非認可之刪改；
 - 產品被用作商業或工業用途；
 - 產品經非認可之技術人員改裝或加裝任何配件；
 - 機身編號被擅自塗改、破壞或刪除。
4. 總代理有權選擇維修或更換配件或其損壞部份。
5. 產品一經被轉讓，其保用即被視作無效。

1. Customer who fails to present original purchase invoice will not be eligible for free warranty service.
2. Customer should always follow the operating instructions. This warranty does not apply to:
 - labour costs for on-site installation, check-up, repair, replacement of parts and other transportation costs;
 - damages caused by accidents of any kind (including material transfer and others);
 - operating failures resulting from applying incorrect voltage, improper usage, and unauthorized installations or repairs.
3. This warranty is invalid if:
 - the purchase invoice is modified by an unauthorized party;
 - the product is used for any commercial or industrial purposes;
 - the product is repaired or modified by unauthorized personnel, or unauthorized parts are installed;
 - the serial number is modified, damaged or removed from the product.
4. German Pool will, at its discretion, repair or replace any defective part.
5. This warranty will be void if there is any transfer of ownership from the original purchaser.

客戶服務及維修中心

中國香港

九龍大業街59號

三湘九龍灣貨運中心地下B室

電話：+852 2333 6249

傳真：+852 2356 9798

電郵：repairs@germanpool.com

中國澳門

澳門青洲大馬路(青洲新路)

515號美居廣場第二期1樓A座

電話：+853 2875 2699

傳真：+853 2875 2661

Customer Service & Repair Centre

Hong Kong, China

Unit B, G/F, Sunshine Kowloon Bay

Cargo Centre, 59 Tai Yip Street,

Kowloon, Hong Kong

Tel : +852 2333 6249

Fax : +852 2356 9798

Email : repairs@germanpool.com

Macau, China

A, 1 Andar, Mei Kui Kuong Cheong Fase 2,

No.515 Avenida Do Conselheiro Borja

Macau

Tel : +853 2875 2699

Fax : +853 2875 2661

此保用只適用於香港及澳門

This warranty is valid only in Hong Kong and Macau

German Pool (Hong Kong) Limited

Hong Kong, China

Room 113, Newport Centre Phase II, 116 Ma Tau
Kok Road, Tokwanan, Kowloon, Hong Kong.
Tel: +852 2773 2888
Fax: +852 2765 8215

Mainland China

8th, Xinxiang Road, Wusha Industrial Park,
Daliang, Shunde, Foshan, Guangdong
Tel: +86 757 2219 6888
Fax: +86 757 2219 6809

Macau, China

A, 1 Andar, Mei Kui Kuong Cheong Fase 2,
No.515 Avenida Do Conselheiro Borja, Macau
Tel: +853 2875 2699
Fax: +853 2875 2661



香港《S MARK》
安全認證



中國櫥櫃/家電行業
十大影響力品牌



CEO非凡品牌大賞



香港優質商標



香港工商業獎



2007
最具潛質
創星品牌企業獎



香港中小企業
最佳成績大獎



香港消費者推祟品牌



香港《心博》
優質服務證書



香港名牌十年成就獎
HONG KONG TOP BRAND TEN YEAR
ACHIEVEMENT AWARD

© All rights reserved. Copying, reproducing or using the contents of this manual is not allowed without prior authorization from German Pool, violators will be prosecuted.