

3D Auto-Spin Healthy Air Fryer | CKF-215



Online Warranty Registration



Please read these instructions and warranty information carefully before use and keep them handy for future reference.

USER MANUAL

請即進行保用登記!

有關保用條款細則，請看本說明書最後一頁。

Please register your warranty information now!

For Warranty Terms & Conditions,

please refer to the last page of this user manual.

Table of Contents

Warnings and Recommendations	04
Product Structure	09
Operating Instructions	10
Cleaning & Maintenance	12
Accessories	13
Technical Specifications	13
Warranty Terms & Conditions	23

Warnings and Recommendations

1. Use of any electrical appliances require the following safety rules

- Do not use the appliance outdoors.
- Use the original supplied Pot. Do not use any other substitute pots and pans.
- Keep it away from other cookers.
- Do not use it too close to flammable materials such as curtains, cabinets, and the wall.
- Keep it away from any hot stove or oven.

2. When turning off the power

- Turn off the power before removing the plug from the socket.
- Do not expose the power cord to hot surfaces; allow the product to cool down completely before unplugging the power cord.

3. To properly use the product

- Keep the product out of reach of children. When using this product, do not let children get close to it.

Warnings and Recommendations

- Appliances are not intended to be operated by means of an external timer or separate remote-control system.
- This appliance is intended to be used in household and similar applications such as:
 - staff kitchen areas in shops, offices and other working environments;
 - farm house;
 - by clients in hotels, motels and other residential type environments;
 - bed and breakfast type environments
- This appliance is not intended for use by persons (including children) with reduced physical, sensory or mental capabilities, or lack of experience and knowledge, unless they have been given supervision or instruction concerning use of the appliance by a person responsible for their safety.
- Children should be supervised to ensure that they do not play with the appliance.

4. Safety considerations

- Do not use the product if damaged or malfunctions. Do not use accessories not recommended by the manufacturer, as this can lead to fire hazard and electric shock.
- Do not use this product other than its intended purposes.
- When the cooker is switched off, unplug it from the wall socket.
- The Pot can be immersed in water to cool down.
- The Glass Cover of the product is breakable, please handle with care.
- If there is a problem with the cooker, do not repair it yourself. Repair should be handled by a professional.

5. Electrical requirements

- Check if the rated voltage of the appliance matches the local mains voltage.
- If the socket does not match the plug, install the right plug before using the unit.

Warnings and Recommendations

6. Warning

- To prevent the risk of electric shock, do not splash water on the Power Cord or Plug.
- Do not disassemble the product arbitrarily, as incorrect configuration may cause electric shock when used.
- Do not touch the lid with bare hand during operation.
- If the Pot has not been cooled, use oven gloves or a piece of cloth to cover the sides of the Pot when taking it out.

7. Operating Instructions

- Please note: when using the product for the first time, you may smell a slight odor. Do not worry. This is due to the combustion of production residue, which is completely normal. It will slowly disappear.

8. Introduction to Operation

- Please read the Instruction Manual and the

Warnings and Recommendations

Label on the product before use.

- Only use after full understanding.
- Use soapy water to clean the Pot and the Lid, but make sure it is dry before use.
- Product accessories, such as Spinning Air-Fry Basket, Rotisserie, Dual Rack and Plate Lifter are allowed to be washed clean.
- Do not immerse the entire unit in water. Use a soft dish cloth to wipe the dirty parts, especially around the Inner Cover where the Halogen Light is. Wait for it to dry before use.
- Do not spray water on the appliance, lest water seeps into the appliance and damage its electrical components to cause accidents.
- The appliance can only be used with the Pot put in place.

Product Structure

Main Body



Control Panel

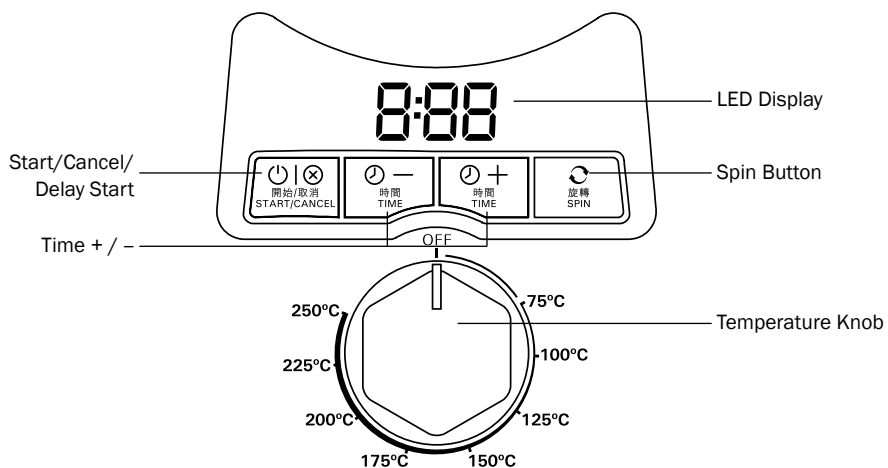

Operating Instructions







Standby Mode

After the power is turned on, the buzzer gives a beep sound, the LED display starts, and the time displays “0:00” to enter the Standby Mode.













Cook Mode







There are two ways to start cooking :

1. During Standby Mode, set the Time by using the “TIME +/-” Button  +  — and set the Temperature by turning the Knob. Press “START/CANEL” Button  |  to confirm.
2. During Standby Mode, set the Temperature and set the Time. Press “START/CANEL” Button  |  to confirm.



Delay Start Function

1. During the Standby Mode, the LED display shows “0:00”. Press both “START/CANEL” Button  |  and “TIME -” Button  — at the same time, hold down for 3 seconds, the machine will continue to beep until the entire setting is done. The LED display will be blinking “P”, “0:00” and “A” one by one. Set the time for Delay Start by pressing “Time +”  +, and then press “START/CANEL” Button  |  to confirm. Set the Cooking time for by pressing “Time +”  +, and then press “START/CANEL” Button  |  to confirm. Then turn the knob to set the temperature. The product defaults to SPIN. If you do not require the SPIN function, press the “SPIN” Button  to turn it off.
2. Setting is now done. The beep sound stopped. If the Delay Start is set for 2 hours, the LED display will be blinking “P”, “2:00”, and “A” if spinning is required. If no spinning is required, the LED display will be blinking “P” and “2:00” alternatively.

Changing the Time Setting







During the Standby Mode or Delayed Start Mode, can change the time setting by pressing the “TIME +/-” Button  +  — to set the Delay Start Time or Cooking Time. The LED display records the time changes. Press the “TIME +/-” Button  +  — each time adds or minus 1 minute. Press and hold the “TIME +/-” Button  +  — each time adds or minus 10 minutes. The range of time adjustment is from 0:00 to 9:59 and can be adjusted cyclically.

Auto-Spin Function



During the Cook Mode, the product defaults to spin. Press the “SPIN” Button  to stop spinning, and press the “SPIN” Button  again to resume spinning.

Operating Instructions

Temperature Adjustment

1. After setting the time, adjust the Temperature by turning the Temperature Knob so that the Knob Arrow indicator points to the desired Temperature, then press the “START/CANEL” Button  |  to enter the Cook Mode with Burner Motor and the Optical Tube turned on.
2. After setting the time, press the “START/CANEL” Button  | , the motor of the burner spins automatically, then adjust the Temperature by turning the Temperature Knob to start heating. During In the heating, press the “START/CANEL” Button  | , the LED display time is displayed as 0:00, then the motor continues to work until the Temperature of the Pot dropped to below 100° C to stop working.

Motor Speed Adjustment

During the Cook Mode, can adjust the Motor Speed by turning the Knob. There are two gears: High Speed  and Low Speed .

Pause Function

During the Cook Mode, when the Lid is lifted and the LED Display showing remaining cooking time will be paused and saved, any other buttons will be locked, and the Motor and Optical Tube will stop working. The cooking and LED display time countdown will resume from where it is left behind once the Lid is put back in place. However, the countdown towards delayed start time won't be affected by lifting the Lid.

Sleep Mode

After the power is turned on and the Standby Mode is reached, if there is no operation for 10 seconds, the LED display will go out until any button is pressed or the Knob is turned. If the operation is to press any of the 4 Buttons, the LED display will only display 0:00 (so the secondary button only wakes up the LED display, not the function setting), when the display shows 0:00, then Start the above setup operation.

Care & Maintenance

Note:

- Unplug power cord and cool down cooking pot before cleaning or washing.
- While cleaning the cooking pot, avoid any form of tapping, knocking or striking against the glass container lest cracks or breakage may result.





Watch the video clip



1. The glass container and the lid can be cleaned by soap water. Dry the unit thoroughly after cleaning.
2. Product accessories, such as Spinning Air-Fry Basket, Rotisserie, Dual Rack and Plate Lifter are allowed to be washed clean.
3. Do not immerse the whole unit in water. Instead, gently wipe stains with a soft cloth. Thoroughly dry the unit for the next application.
4. Do not spray water on the appliance lest water seeps into the appliance and damage its components.

Accessories

Supplied Accessories

Spinning Air-Fry Basket		Suitable for cooking small pieces of foods, such as French fries, nuts, and dried fruit, etc.
Rotisserie		Suitable for cooking a large poultry such as chicken, duck and goose.
Dual Rack		Allow food to be placed near heat source, e.g. skewers, BBQ pork, pork neck, chicken wings.
Plate Lifter		To carry food or plate in and out of the cooking pot.

Technical Specifications

Model	CKF-215
Voltage/Frequency	220 V / 50 Hz
Power	1500 W
Dimensions	(H) 362mm (W) 375mm (D) 410mm
Capacity	9 L
Net Weight	Approx. 5.48 kg

Specifications are subject to change with prior notice.

If there is any inconsistency or ambiguity between the English and the Chinese version, the Chinese Version shall prevail.

Refer to www.germanpool.com for the most up-to-date version of the Operating Instructions.

目錄

注意事項 15

產品結構 17

操作說明 18

清潔與保養 20

配件 21

技術規格 22

保用條款 23

注意事項

1. 使用任何電器均需要注意以下安全規則：

- 不要於戶外使用。
- 使用時要用原配的鍋，不能用其他煮食器具。
- 必須遠離其他爐具。
- 不要在靠近窗簾、牆壁、櫥櫃等易燃材料的位置使用。
- 將本產品遠離任何熱爐和加熱烤箱。

2. 拔出電源線時：

- 要將插座先關閉，然後再從插座中拔出。
- 不要讓電源線接觸發熱表面，並讓設備完全冷卻才拔出。

3. 妥善使用：

- 不得放在兒童能觸碰的地方，尤其在使用本產品的時候，不得讓兒童走近。
- 不應透過外部計時器或單獨的遠程控制系統來操作本產品。

本產品旨在用於家庭和相類似的應用，例如：

- 商店、辦公室和其他工作環境中的員工廚房區域；
- 農舍；
- 酒店、旅館和其他住宅類型環境；
- 民宿、早餐類型的環境。

本設備不適用於肢體、感官或心理缺憾，或缺乏經驗和知識的人（包括兒童）使用，除非有負責其安全的人員監督或指導他們使用本產品。

應該督導兒童，以確保他們不會玩耍本產品。

4. 安全考慮：

- 本產品損壞或故障後請勿使用；請勿使用未經製造商推薦的配件，因為這可能會導致火災或觸電受傷。
- 不要使用超過其他用途的設備。
- 當本產品處於關閉時，請從插座插頭拔出電源。
- 鍋可以浸在水中冷卻。
- 煮食器具帶有玻璃製品容易破碎，請小心處理。

注意事項

- 如果本產品有故障或其他問題，不得自行修理，維修應由專業人士處理。
- 5. 電器要求：**
- 請您檢查產品功率標籤的電壓和插座與您使用的電壓和插座是否相一致。
 - 如果與本產品不一致，請使用一致的電壓和插座。
- 6. 警告：**
- 為防止觸電危險，不要把水濺在電源線或插頭上。
 - 不要自行拆卸設備，因為不正確的組裝在使用時可能導致觸電危險。
 - 在操作過程中切勿用手觸摸蓋子。
 - 當鍋身還未冷卻，取出鍋時應使用烤箱手套或用布包住鍋邊。
- 7. 操作說明：**
- 請注意，初次使用時您可能會聞到一陣輕微的氣味，這是由於生產殘留物燃燒時所致，屬於正常現象，使用後就會慢慢消失。
- 8. 操作入門：**
- 在使用前請閱讀說明書和產品上的使用標籤。
 - 了解清楚後才能使用。
 - 清洗鍋和蓋子時可使用肥皂水，清洗完請晾乾或擦乾才再次使用。
 - 產品配件亦可清洗，旋轉烤籠、旋轉烤叉、高架、取物夾。
 - 請勿將機體直接放在水中清洗，只可以用軟抹布在有污漬處拭擦，然後等各部分的水漬晾乾後才能繼續使用。
 - 不能將水澆於機身上，避免水漬侵入各部分電器元件造成安全事故。
 - 必須將鍋放入機體後才能使用。

產品結構

主機



控制面板

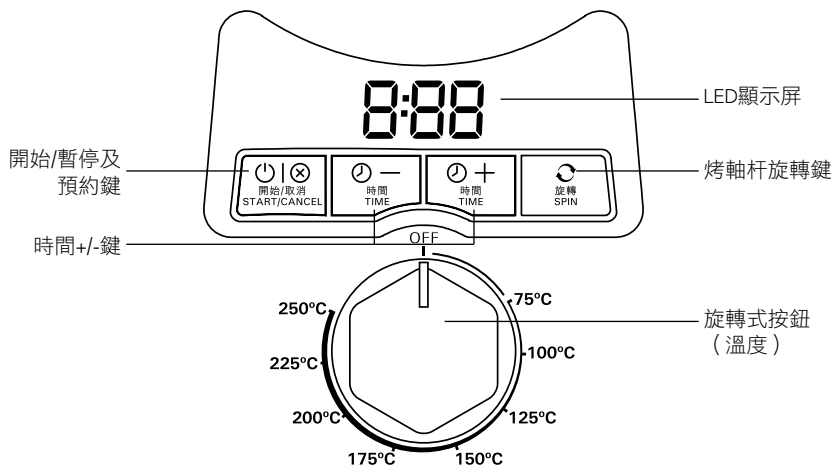

操作說明

開機狀態

接通電源後，蜂鳴器發出提示聲響一聲，LED顯示屏啟動，時間顯示「0:00」，進入待機狀態。

觀看操作視頻



開始烹調

您可透過以下兩種方式開始烹調：

1. 在待機狀態下，按「時間+/-鍵」 $\odot + \odot$ — 設置烹調時間，然後旋轉旋鈕設置溫度，按「開始/暫停鍵」 $\odot | \otimes$ 開始烹調。
2. 在待機狀態下，旋轉旋鈕設置溫度，然後按「時間+/-鍵」 $\odot + \odot$ — 設置烹調時間，按「開始/暫停鍵」 $\odot | \otimes$ 開始烹調。

預約設置

1. 在待機狀態下，長按「開始/暫停鍵」 $\odot | \otimes$ 及「時間-鍵」 $\odot -$ 3秒進入預約設置狀態，蜂鳴器提示聲響長響直至操作完成，此時LED顯示屏顯示「P」、「0:00」與「A」交互閃爍，通過「時間+/-鍵」 $\odot + \odot$ — 設置需要預約的時間，再按「開始/暫停鍵」 $\odot | \otimes$ 進入烹調設定，此時LED顯示屏顯示「0:00」，通過「時間+/-鍵」 $\odot + \odot$ — 設置烹調時間，然後旋轉旋鈕設置溫度，如果不需要電機轉動，按「烤軸杆旋轉鍵」 $\odot \curvearrowright$ （如需要轉動，則不需要按此鍵）。
2. 完成操作後，按「開始/暫停鍵」 $\odot | \otimes$ 結束預約設置並進入倒數。此時LED顯示屏的顯示方式為兩種（如設置2小時的預約）：需要同步電機轉動「P」、「2:00」與「A」交互閃爍；不需電機轉動「P」、「2:00」交互閃爍。

時間調節

在待機或預約狀態下，按下「時間+/-鍵」 $\odot + \odot$ — 調節預約或烹調時間，LED顯示屏隨著調節而變化，每按一下以1分鐘變化，若連續按住不放，時間會以10分鐘步進變化。時間調節範圍為0:00至9:59，可循環調節。

烤軸杆旋轉



在烹調狀態下，產品默認為轉動，按「烤軸杆旋轉鍵」 $\odot \curvearrowright$ ，烤軸杆會停止轉動，再按「烤軸杆旋轉鍵」 $\odot \curvearrowleft$ ，烤軸杆恢復轉動；在預約狀態下也如此。

溫度調節



在待機狀態下，調節溫度旋鈕，使旋鈕指示箭頭指向所需要的溫度，再按「開始/暫停鍵」 $\odot | \otimes$ ，爐頭電機、光波管進入工作狀態。在待機狀態下，按「開始/暫停鍵」 $\odot | \otimes$ ，爐頭電機轉動，再調節旋鈕對應溫度後，光波管進入加熱工作。在加熱工作中，按下「開始/暫停鍵」 $\odot | \otimes$ ，LED顯示屏時間顯示為0:00，此時電機繼續工作，直至爐心溫度低於100°C才停止工作。

操作說明

風速調節

在工作狀態下，調節風速旋鈕，可改變電機轉速，兩檔分別為：高速檔  及低速檔 。

暫停功能

在烹調過程中，把上蓋掀起，LED顯示屏的數值會停頓（剩餘烹調時間會被暫停及保存），除「開始/暫停鍵」|外，任何按鍵操作都會處於保護狀態，同時電機和光波管也都停止工作；將上蓋放下即可繼續烹調；此功能由微動開關斷通控制。

睡眠功能

接通電源進入待機狀態後，如10秒鐘內沒有任何操作，LED顯示屏將會熄滅，直至按下任意一個按鍵或旋動旋鈕為止。如操作是按下4個按鍵中的任意一個，LED顯示屏都只顯示0:00（因此次按鍵只為喚醒LED顯示屏，並不是進行功能設置），當顯示屏顯示0:00時，再開始上述的設置操作。

清潔與保養

注意：

- 清潔煮食鍋機件前必須先拔下電源，待機件完全冷卻後方可進行。
 - 清洗時，請避免碰撞玻璃鍋體，以免造成暗傷或導致破裂。
1. 可用肥皂水清洗玻璃鍋和鍋蓋，清洗完畢後需晾乾或擦乾方可繼續使用。
 2. 產品配件亦可清洗，旋轉烤籠、旋轉烤叉、高架、取物夾。
 3. 不可將機器直接放在水中清洗，只可以用軟抹布輕輕拭擦發熱線等容易積聚污漬的地方。待全部水漬乾了之後才能繼續使用。
 4. 不可澆水於機身上，避免水漬滲透電器元件造成損壞。

觀看操作視頻



配件

隨機配件

旋轉烤籠		適用於烹調較零碎的食物，如：薯條、堅果、果乾等。
旋轉烤叉		適用於烹調大型家禽類食物，如：原隻雞、鴨、鵝等。
高架		適用於需靠近發熱體的食物，如：串燒、叉燒、豬頸肉、雞翼。
取物夾		用以取出器皿或食物，以防燙手。

技術規格

型號	CKF-215
電壓 / 頻率	220 V / 50 Hz
功率	1,500 W
機身尺寸	(H) 362mm (W) 375mm (D) 410mm
容量	9 L
淨重	約5.48 kg

產品規格及設計如有變更，恕不另行通知。
中英文版本如有出入，一概以中文版為準。
本產品使用說明書以 www.germanpool.com 網上版為最新版本。

保用條款

此保用提供德國寶產品之機件在正常使用下壹年保用(自購買日起計算)。

* 貴戶須在購機十天內，以下列其中一種方式向本公司登記資料，保用手續方正式生效：

1) 填妥本公司網頁內之保用登記表格

www.germanpool.com/warranty

2) 填妥保用登記卡，郵寄至本公司。



Warranty Terms & Conditions

Under normal operations, the product will guarantee a 1-year full warranty provided by German Pool (effective from the date of purchase).

* This warranty is not valid until customer registration information is received by our Service Centre within 10 days of purchase via one of the following means:

1) Visit our website and register online:

www.germanpool.com/warranty

2) Complete all the fields on the attached Warranty Card and mail it back to our Customer Service Centre.



另請填妥以下表格並與正本發票一併保存，以便維修時核對資料。用戶提供之所有資料必須正確無誤，否則免費保用將會無效。 Please fill out the form below. This information and the original purchase invoice will be required for any repairs. Warranty will be invalidated if information provided is found to be inaccurate.

型號 Model No. : **CKF-215**

機身號碼 Serial No. : _____ 發票號碼 Invoice No. : _____

購買商號 Purchased From : _____ 購買日期 Purchase Date : _____

- 未能出示購買發票正本者，將不獲免費維修服務。
- 用戶應依照說明書的指示操作。本保用並不包括：
 - 上門安裝、檢驗、維修或更換零件之人工以及一切運輸費用；
 - 因天然與人為意外造成的損壞 (包括運輸及其他)；
 - 電源接合不當、不依說明書而錯誤或疏忽使用本機所引致之損壞。
- 於下列情況下，用戶之保用資格將被取消：
 - 購買發票有任何非認可之刪改；
 - 產品被用作商業或工業用途；
 - 產品經非認可之技術人員改裝或加裝任何配件；
 - 機身編號被擅自塗改、破壞或刪除。
- 總代理有權選擇維修或更換配件或其損壞部份。
- 產品一經被轉讓，其保用即被視作無效。

- Customer who fails to present original purchase invoice will not be eligible for free warranty service.
- Customer should always follow the operating instructions. This warranty does not apply to:
 - labour costs for on-site installation, check-up, repair, replacement of parts and other transportation costs;
 - damages caused by accidents of any kind (including material transfer and others);
 - operating failures resulting from applying incorrect voltage, improper usage, and unauthorized installations or repairs.
- This warranty is invalid if:
 - the purchase invoice is modified by an unauthorized party;
 - the product is used for any commercial or industrial purposes;
 - the product is repaired or modified by unauthorized personnel, or unauthorized parts are installed;
 - the serial number is modified, damaged or removed from the product.
- German Pool will, at its discretion, repair or replace any defective part.
- This warranty will be void if there is any transfer of ownership from the original purchaser.

客戶服務及維修中心

香港

九龍灣啟興道1-3號

九龍貨倉10樓

電話：+852 2333 6249

傳真：+852 2356 9798

電郵：repairs@germanpool.com

澳門

澳門俾利喇街145號

寶豐工業大廈3樓

電話：+853 2875 2699

傳真：+853 2875 2661

Customer Service & Repair Centre

Hong Kong

10/F, Kowloon Godown

1-3 Kai Hing Road, Kowloon Bay,

Kowloon, Hong Kong

Tel : +852 2333 6249

Fax : +852 2356 9798

Email : repairs@germanpool.com

Macau

3/F, Edificio Industrial Pou Fung,

145 Rua de Francisco Xavier Pereira,

Macau

Tel : +853 2875 2699

Fax : +853 2875 2661

此保用只適用於香港及澳門

This warranty is valid only in Hong Kong and Macau

German Pool (Hong Kong) Limited

Hong Kong

Room 113, Newport Centre Phase II, 116 Ma Tau
Kok Road, Tokwawan, Kowloon, Hong Kong
Tel: +852 2773 2888
Fax: +852 2765 8215

China

8th, Xinxiang Road, Wusha Industrial Park,
Daliang, Shunde, Foshan, Guangdong
Tel: +86 757-2219 6888
Fax: +86 757-2219 6809

Macau

3/F, Edificio Industrial Pou Fung,
145 Rua de Francisco Xavier Pereira, Macau
Tel: +853 2875 2699
Fax: +853 2875 2661



香港《S MARK》
安全認證



中國標榜/家電行業
十大影響力品牌

CEO

CEO非凡品牌大賞



香港優質商標



香港工商業獎



2007
最具潛質
創星品牌企業獎



香港中小企業
最佳拍檔大獎



香港消費者推祟品牌



香港《O獎》
優質服務證書



香港名牌十年成就獎
HONG KONG TOP BRAND TEN YEAR
ACHIEVEMENT AWARD

©All rights reserved. Copying, reproducing or using the contents of this manual is not allowed without prior authorization from German Pool, violators will be prosecuted.