

WiFi Smart Mirror Bathroom Heater

HTW-M20-SC



Online Warranty Registration



Please read these instructions and warranty information carefully before use and keep them handy for future reference.

## USER MANUAL

# Table of Contents

---

|                               |    |
|-------------------------------|----|
| Warnings & Safety Precautions | 03 |
| Product Structure             | 05 |
| Installation Instructions     | 06 |
| Operation Instructions        | 09 |
| Cleaning & Maintenance        | 23 |
| Troubleshooting               | 24 |
| Technical Specification       | 24 |
| Warranty Terms & Conditions   | 47 |

# Warnings & Safety Precautions

---

## Note:

- IP24 protection rating only applies to wall-mounted installation.
- This product is a heater. Do not use this product as a fan.

## **WARNING!**

Read all instructions carefully before using this product.

- This product is for domestic indoor use only. If this product is used for any commercial, industrial, rental or other purposes, product warranty will be VOIDED.
  - This product is not intended for use by children or persons with reduced physical, sensory or mental capabilities, or lack of experience and knowledge, unless they have been given supervision or instruction concerning use of this product by an adult responsible for their safety.
  - Mind your children and DO NOT let children play with this product.
  - Cleaning and user maintenance shall not be made by children without supervision.
  - Check the voltage indicated on the rating label before using this product.
  - If the supply cord is damaged, it must be replaced by the manufacturer, its service agent or similarly qualified persons in order to avoid hazards.
  - Unplug this product from the power source before cleaning and maintenance.
  - Contact German Pool authorized service technician for repair or maintenance of this product.
1. Please read all instructions carefully before using this product.
  2. Before use, please check whether the voltage used is consistent with the voltage on the rating label of this product.
  3. This product can be used by children aged from 8 years and above and persons with reduced physical, sensory or mental capabilities or lack of experience and knowledge if they have been given supervision or instruction concerning use of this product in a safe way and understand the hazards involved. Cleaning and user maintenance shall not be made by children without supervision.
  4. Children of less than 3 years should be kept away from this product unless continuously supervised.
  5. Children aged from 3 years and less than 8 years shall only switch on/off this product provided that it has been placed or installed in its intended normal operating position and they have been given supervision, instruction, or assistance concerning use of this product in a safe way and understand the hazards involved. Children aged 3-8 years old are only allowed to turn this product on/off. Children aged from 3 years and less than 8 years shall not plug in, regulate and clean this product or perform user maintenance.
  6.  **WARNING!** some parts of this product can become very hot and cause burns. Particular attention must be given where children and vulnerable people are present.
  7. This product is not intended for use by persons (including children) with reduced physical, sensory or mental capabilities, or lack of experience and knowledge, unless are supervised by a person responsible for their safety.

# Warnings & Safety Precautions

---

8. Children should be supervised to ensure that they do not play with this product.
9. ⚠ **WARNING!** In order to avoid overheating, DO NOT cover this product.
10. DO NOT use this product in the immediate surroundings of a bath, a shower or a swimming pool.
11. DO NOT use this product if it has been dropped.
12. This product must not be located immediately below a socket-outlet.
13. DO NOT use if there are visible signs of damage to this product.
14. If the supply cord is damaged, it must be replaced by a special cord or assembly available from the manufacturer or its service agent.
15. Use this product on a flat and stable surface. (Note: After installation, the bottom of the product should be 1-1.8 meter off the ground, and distance to the sidewall should be more than 0.3 meter. If this product is used in the bathroom, it should be at least 1 meter away from the water source).
16. ⚠ **WARNING!** DO NOT use this product in small rooms when they are occupied by persons not capable of leaving the room on their own, unless constant supervision is provided.
17. ⚠ **WARNING!** In order to avoid a hazard for very young children, this product should be installed so that the lowest heated rail is at least 1 meter above the floor.
18. This product must be placed in a location where switches and other controls cannot be touched by a person in the bath or shower.
19. This product for household and indoor use only.
20. Switch and control panel cannot be touched by wet hand.
21. For additional protection, the installation of a residual current device (RCD) having a rated residual operating current not exceeding 30 mA is advisable in the electrical circuit supplying the bathroom. Ask your installer for advice.
22. This product is intended only for drying textiles washed in water.
23. The plug of this product shall be protected, for example, away from the water source, or the plug shall be protected with a waterproof box.
24. DO NOT ingest battery, Chemical Burn Hazard.
25. ⚠ **WARNING!** This product contains a coin / button cell battery. If the coin / button cell battery is swallowed, it can cause severe internal burns in just 2 hours and can lead to death.
26. Keep new and used batteries away from children.
27. If the battery compartment does not close securely, stop using the remote control and keep it away from children.
28. If you think batteries might have been swallowed or placed inside any part of the body, seek immediate medical attention.
29. The batteries contain materials which are hazardous to the environment; they must be removed from this product before it is scrapped and that they are disposed of safely.
30. ⚠ **WARNING!** To reduce the risk of fire, keep textiles, curtains, or any other flammable material a minimum distance of 1 m from the air outlet.

# Product Structure

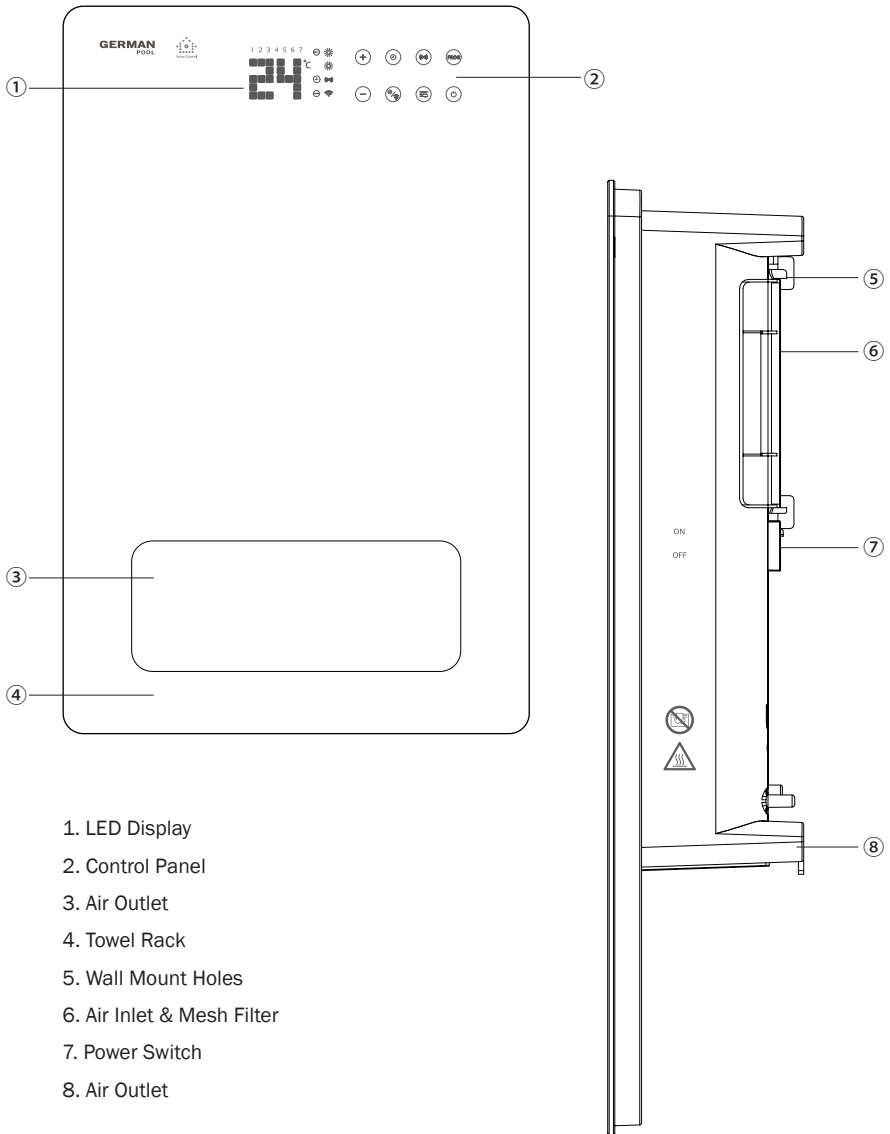

# Installation Instructions

## Installation Safety Requirements

### Wall-Mounted Installation

To meet IP24 protection rating, this product must be mounted on the wall. If it is used in the bathroom, it should be installed at least 1 meter away from the water source.

#### ⚠ WARNING!

When installing this product, must leave ample space on all sides to ensure adequate ventilation and heat dissipation.

1. Leave at least 500mm above the product.
2. Leave at least 300mm on either side of the product.
3. Leave 1,000-1,800mm from the ground.

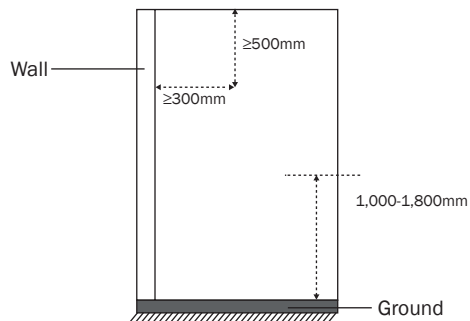

#### ⚠ WARNING!

- This product can only be installed beyond ZONE 1 and 2.
- This product must be installed so that switches and other controls cannot be touched by a person in the bath or shower.

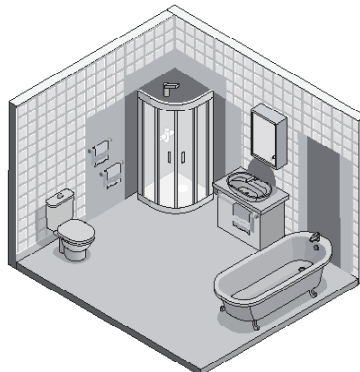
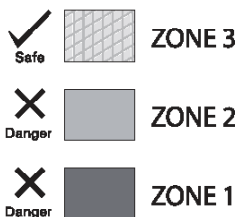

# Installation Instructions

## Installation Steps

1. Drill three  $\varnothing 6$  holes in a load-bearing wall according to the dimensions below.

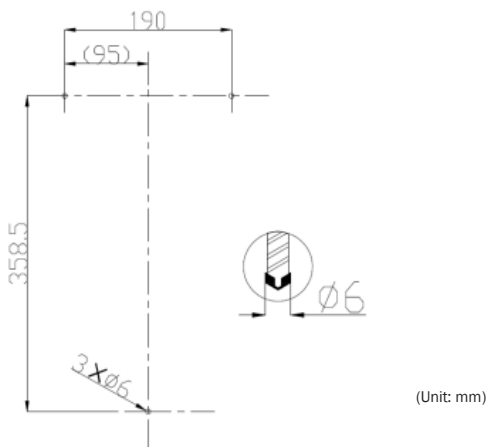

2. Insert plastic wall plugs into the three holes, and screw two ST4\*35 large flat head self-tapping screws into the top two holes (Note: must leave 4mm space between the screw head and the wall).

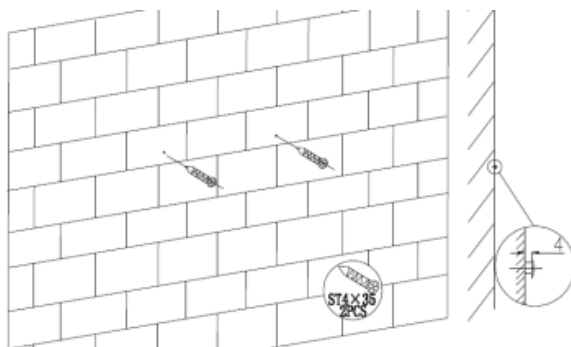

# Installation Instructions

---

3. Align the screw holes on the back of this product with the screws on the wall, then gently pull the product downwards until the screws fit snugly over the holes and the product hangs securely on the wall.

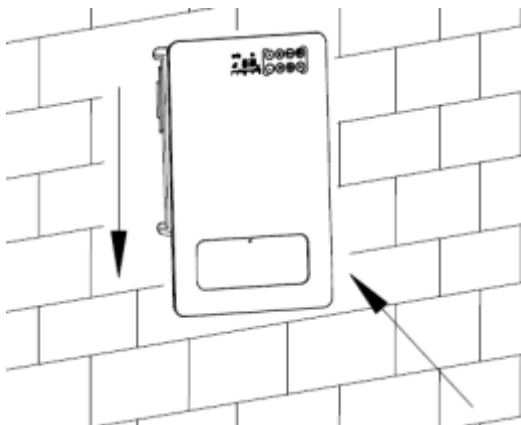

4. Align the bottom hole of the product back casing with the bottom plastic plug, and screw in one ST4\*35 large flat head self-tapping screw until the product is securely mounted onto the wall.

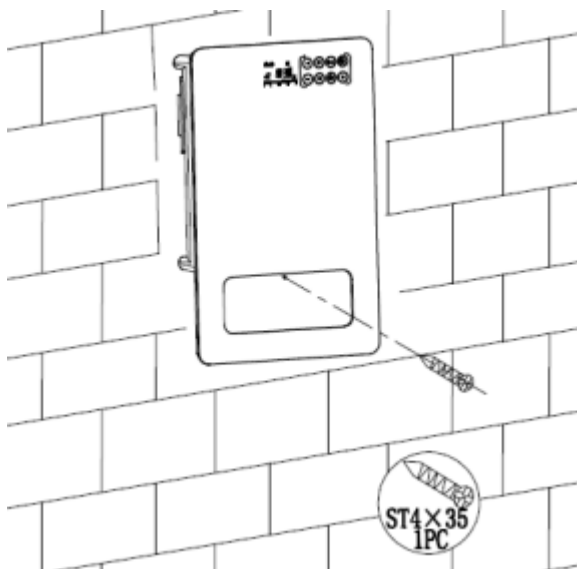



# Operation Instructions

## Control Panel

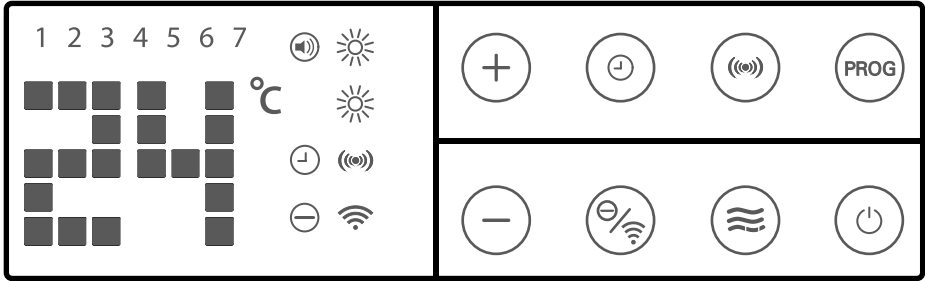

| LED Display   |                                 | Control Keys (Same For Remote Control) |                   |
|---------------|---------------------------------|--|-------------------|
| 1 2 3 4 5 6 7 | Day Of The Week Display         |  | Increase Key      |
|               | Temperature / Time Display      |  | Decrease Key      |
|               | Temperature Indicator Light     |  | Clock / Timer Key |
|               | Clock / Timer Indicator Light   |  | Anion / WiFi Key  |
|               | Quiet Mode Indicator Light      |  | Motion Sensor Key |
|               | High / Low Mode Indicator Light |  | Mode Key          |
|               | Motion Sensor Indicator Light   |  | Program Key       |
|               | Anion Indicator Light           |  | On / Off Key      |
|               | WiFi Indicator Light            |  |                   |

# Operation Instructions

---

## Remote Control

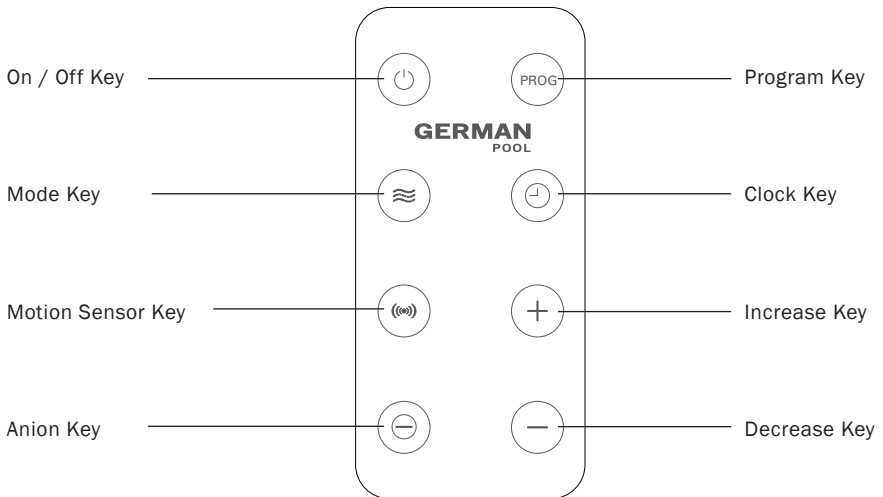

# Operation Instructions

---

## A. Basic Operation

### Note:











- Whether you are operating this product via the control panel on the main unit or via the remote control, the procedure is the same. (“Set Current Day and Time”, “Off Timer Function” and WiFi Connection are not support by remote control)
- When operating with the remote control, make sure to point it directly towards this product’s LED panel to maximize the signal reception.

### A1. Set Current Day and Time (when using this product for the first time)

1. Connect to the power source. Switch on the Power Switch located on the back of the product. Buzzer beeps twice, all function keys light up constant and Temperature/Time Display shows the current room temperature, and product enters standby state. In standby state, tap On/Off Key  to turn on the product.

### Note:



If the product receives no command in 10 seconds, Display Panel will go dark except for Temperature/Time Display and On/Off Key . Tap any key and all function keys will light up again.

2. When product is turned on, tap and hold Clock/Timer Key  for 3 seconds to enter “Day and Time Setting”.
3. Tap Increase Key  or Decrease Key  to select current day of the week (1-7 refer to Monday - Sunday), tap Clock/Timer Key  to confirm.
4. Tap Increase Key  or Decrease Key  to select current hour (00-23 refer to 12am-11pm), tap Clock/Timer Key  to confirm.
5. Tap Increase Key  or Decrease Key  to select current minute (00-59), tap Clock/Timer Key  to confirm. Current day and time are now set.
6. After the clock is set, Temperature/Time Display will show current ambient temperature.

### Note:

To check the current time: When the product is turned on, tap Clock/Timer Key  once, Temperature/Time Display will show current hour for 2 seconds, then show current minute for 2 seconds, then show back the current temperature.

### A2. Turn On/Turn Off

1. Turn On: In standby state, tap any key to wake up Control Panel, then tap On/Off Key  to turn on the product, and the product will run according to its previously set parameters.
2. Turn Off: When product is operating, tap On/Off Key  to turn off the product. Product will stop heating immediately, and the heat-dissipating fan will continue to run for 30 seconds, after which the product will return to standby state.





# Operation Instructions

---





## Note:

If product is running but control keys have turned dark, tap any key to wake up the Control Panel first, then tap On/Off Key  to turn off the product.

## A3. High Mode / Low Mode / Quiet Mode

1. Connect to the power source. Product enters standby state, buzzer beeps twice, LED Display shows current ambient temperature and current day and time.
2. Press On/Off Key  to turn on the product. If using for the first time, the product is set to target temperature of 24 °C and High Mode by defaults, icon lights up, Temperature/Time Display shows current ambient temperature.
3. Tap Mode Key  to cycle among Low Mode / Quiet Mode / High Mode.
4. To adjust target temperature, tap Increase Key  to increase temperature or Decrease Key  to decrease temperature by 1 °C increments. User can tap and hold key to speed up adjustment.
5. To turn off the product, tap On/Off Key  and product will return to standby state.





## A4. Setting The Temperature

1. When the product is operating, tap Increase Key  or Decrease Key  to enter Temperature Setting, Temperature Display shows current set temperature. Tap Increase Key  or Decrease Key  again to increase or decrease target temperature to between 5 °C-40 °C.
2. After setting the target temperature, product will automatically confirm setting, and 5 seconds later Temperature Display will show current room temperature.

## Note:

- If product is in Anti-Freeze Mode, target temperature is not adjustable. User must tap Program Key  to exit Anti-Freeze Mode first. (For details, see “B.Advanced Operation”)
- When product has reached target temperature, it will automatically stop heating; when room temperature drops 1 °C below the target temperature, the product will resume heating.

## A5. Off-Timer Function

1. Tap Clock/Timer Key  twice to enter Off-Timer Setting. Temperature/Time Display blinks “0” by default, Clock/Timer Indicator Light blinks.
2. Tap Increase Key  or Decrease Key  to adjust off-timer from 0-24 hr; after setting is complete, product will automatically confirm setting after 5 seconds, Temperature/Time Display Indicator Light lights up constant, and product will start to countdown.
3. To cancel the timer, tap Clock/Timer Key  twice again.

# Operation Instructions

## Note:

- During countdown, Temperature/Time Display will show current temperature and countdown time alternately.
- Off-Timer is only available in P1 program. P2-P5 programs do not support personal setting of off-timers. (For details, see “B.Advanced Operation”)

## B. Advanced Operation

### Preset Weekly Program Mode





This product is equipped with preset weekly programs P1-P5. Product will run in Comfort Mode (product operates at user’s selected temperature and High/Low/Quiet Mode) or Anti-freeze Mode at specific times according to the program selected (Anti-freeze Mode is set to 5 °C by default and not adjustable).

P1: All Day Program / P2: Family Program / P3: Office Program / P4: Commercial Program / P5: Anti-Freeze Program

| Mode | Day Of The Week | Operation  | Description   |
|------|-----------------|--|---|
| P1   | 1-7             | 00:00-24:00 Comfort Mode   | Suitable for daily use  |
| P2   | 1-5             | 00:00-06:30 Anti-freeze Mode/Standby State<br>06:30-08:30 Comfort Mode<br>08:30-17:00 Anti-freeze Mode/Standby State<br>17:00-22:30 Comfort Mode<br>22:30-24:00 Anti-freeze Mode/Standby State   | Suitable for families who work during weekdays and are home during weekends                         |
|      | 6-7             | 00:00-07:30 Anti-freeze Mode/Standby State<br>07:30-10:00 Comfort Mode<br>10:00-12:00 Anti-freeze Mode/Standby State<br>12:00-14:00 Comfort Mode<br>14:00-17:00 Anti-freeze Mode/Standby State<br>17:00-22:30 Comfort Mode<br>22:30-24:00 Anti-freeze Mode/Standby State |   |
| P3   | 1-5             | 00:00-06:00 Anti-freeze Mode/Standby State<br>06:00-17:00 Comfort Mode<br>17:00-24:00 Anti-freeze Mode/Standby State   | Suitable for offices that are open during normal office hours on weekdays and closed on weekends    |
|      | 6-7             | 00:00-24:00 Anti-freeze Mode/Standby State   |   |
| P4   | 1-7             | 00:00-06:00 Anti-freeze Mode/Standby State<br>06:00-22:00 Comfort Mode<br>22:00-24:00 Anti-freeze Mode/Standby State   | Suitable for commercial spaces that are open all week   |
| P5   | 1-7             | 00:00-24:00 Anti-freeze Mode/Standby State   | Suitable for when the room will not be occupied for a prolonged period of time (eg. family on trip) |

# Operation Instructions

---

1. When product is operating, tap Program key  repeatedly to cycle among P1-P5. After selecting desired program, the product will automatically confirm setting after 3 seconds, and Temperature/Time Display will show current temperature.
2. In P1 program, the product will operate in Comfort Mode all day long, user can choose to set temperature, High/Low/Quiet mode and Off Timer if desired; in P2-P5 programs, user can only set temperature, High/Low/Quiet mode and Off Timer for the Comfort Mode time sections. Settings are not adjustable for Anti-freeze Mode time sections.
3. When product is operating in P2-P5 programs, user can tap On/Off key  to manually turn off the product; when user tap On/Off key  to manually turn on the product again, the product will resume running on the previously selected Weekly Program.
4. To exit Preset Weekly Program Mode, tap Program key  and select P1.

## Note:

Anti-freeze Mode is designed specifically for use in cold climate regions, to prevent the product from freezing under extremely cold conditions. In Anti-freeze Mode, the product operates at a target temperature of 5°C:

- If indoor temperature is below 5°C, the product will maintain a constant temperature and warm up the room to 5°C.
- If indoor temperature is above 5°C, the product will automatically deactivate Anti-freeze Mode and enter standby state.

# Operation Instructions

---



## Power-Off Memory Function

1. When power is cut off, the product will stop operating. After power is reconnected, product enters standby state. Tap On/Off Key  to restart the product, product will operate according to its previously set parameters before power cut-off.
2. If product was set to Quiet Mode prior to power cut-off, after power is reconnected, product will first run in High Mode for 15 seconds, then resume Quiet Mode.



### Note:

When power is out off, settings and time data will only be stored for 72 hours. If power is not turned back on within 72 hours, user will need to reset current day and time again.





## Motion Sensor Function

- When product is operating, tap Motion Sensor Key  to turn on this function. When this function is turned on, every time the product detects motion, Motion Sensor Indicator Light will light up, and product will automatically start heating; if no motion is detected in 15 minutes, the product will stop heating, Temperature/Time Display will show current temperature, and all other indicator lights and function keys will go dark.
- To turn off this function, tap Motion Sensor Key  again, and Motion Sensor Indicator Light will turn off.



## Anion Function

- When product is operating, tap Anion/WiFi Key  to turn on anion purification function, Anion Indicator Light will light up constant.
- To turn off this function, tap Anion/WiFi Key  again, and Anion Indicator Light will turn off.

## Child Lock Function

- When product is operating, tap and hold Increase Key  or Decrease Key  for 3 seconds to activate child lock, Temperature/Time Display will show [ ] for 5 seconds then return to original display status, and all keys will be rendered inoperable.
- To deactivate child lock, tap and hold tap and hold Increase Key  or Decrease Key  for 3 seconds again.

## Reset To Factory Default Setting

When product is operating, tap Increase Key  or Decrease Key  simultaneously twice, and product will return to factory default setting of High Mode and 24°C.

# Operation Instructions

## Connecting The Product To WiFi

This product can be controlled via smartphone with German Pool Smart Control APP.

### Note:

To connect the product to WiFi, please use WiFi with a frequency of 2.4 GHz, does not work with WiFi with a frequency of 5.0 GHz.

## A. How To Set Up The APP

1. Connect your phone to 2.4 GHz WiFi then scan the QR Code below, or search "German Pool Smart Control" in App Store or Google Play to download and install the APP.



Apple iOS System  
App Store



Android System  
Google Play

## B. Change The Language

### Apple iOS System

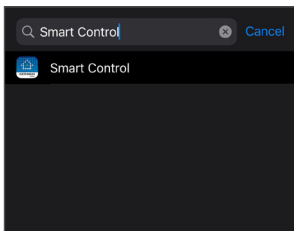

1. Search "Smart Control" in Settings.

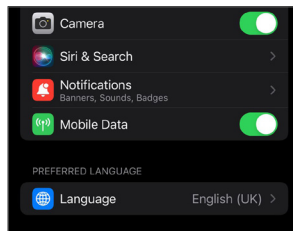

2. Click "Preferred Language".

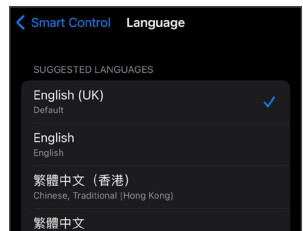

3. Select Traditional Chinese or English in the "Suggested Languages" column (Note: if user select "Traditional Chinese (Hong Kong)", app will display in English).

### Android System

App will appear in your preset phone language. If you need to change APP language, you need to change the system language in your phone settings.



# Operation Instructions

## C. Register Your Account

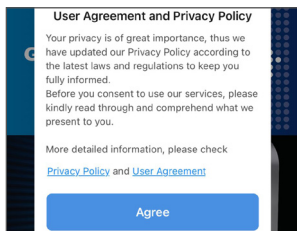

1. Open the APP , click “Agree” on “User Agreement and Privacy Policy”.

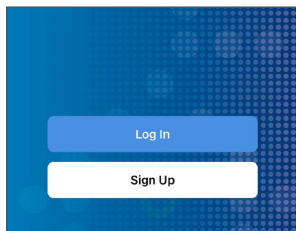

2. Click “Sign Up” to register your account.

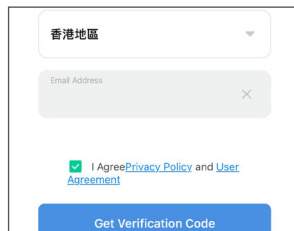

3. Enter your email address, tick “I agree Privacy Policy and User Agreement”, then click “Get Verification Code”.

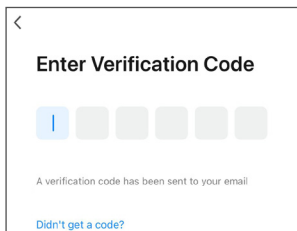

4. Enter one-time verification code from your email.

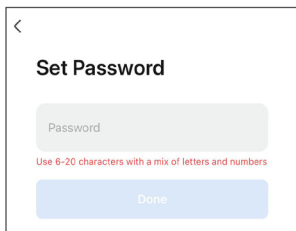

5. Set up your password then click “Done”.

# Operation Instructions

## D. Pairing Sequence

### Method 1: Auto Pairing

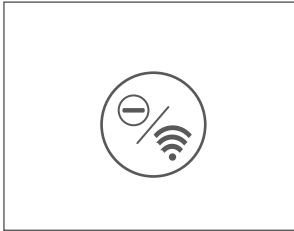

1. Long-press Anion/WiFi Key on the product's control panel for 5 seconds until WiFi Indicator Light blinks and buzzer beeps.

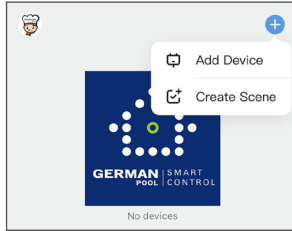

2. Click "+" on the upper right corner of the APP homepage, then click "Add Device".

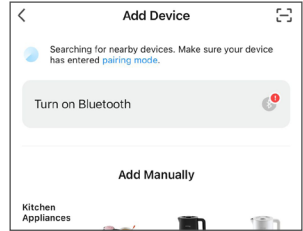

3. Before pairing, user must allow the App to access your Bluetooth. Tap on "Turn on Bluetooth" (if Bluetooth is already on, ignore this step).

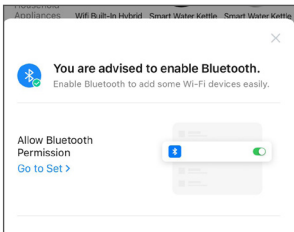

4. Tap "Go To Set" (if Bluetooth is already on, ignore this step).

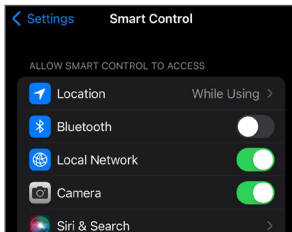

5. Turn on Bluetooth (if Bluetooth is already on, ignore this step).

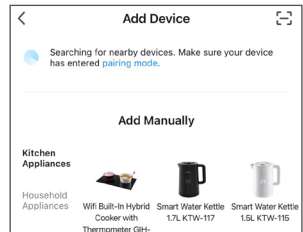

6. APP will show "Searching for nearby devices...".

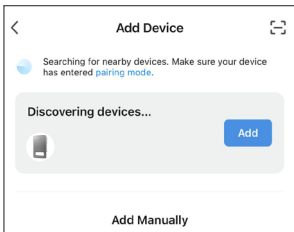

7. APP will show "Discovering devices...", click "Add".

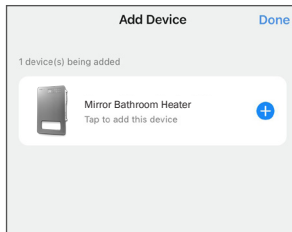

8. Click "+" on the right of product name.

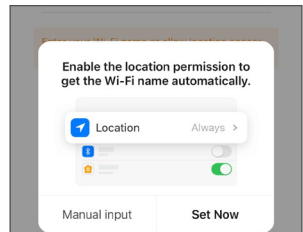

9. it is recommended to allow the APP to access your location. Tap "Set Now" (if Location is already on, ignore this step).

# Operation Instructions

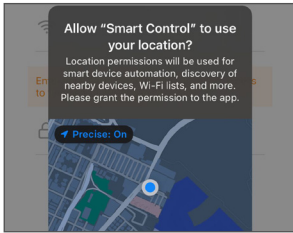

10. Tap “Allow While Using App” (if Location is already on, ignore this step).

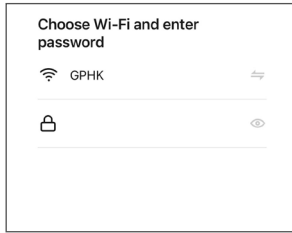

11. Select WiFi name and enter your WiFi password, then click “Next”.

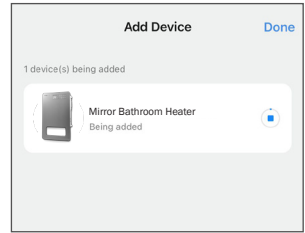

12. APP will show “Being Added”, the product and APP will automatically pair up.

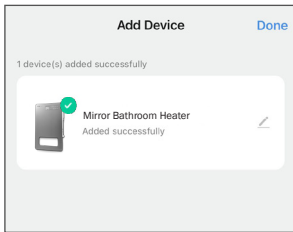

13. When pairing is completed, APP will show “Added successfully”. Click “Done” to return to homepage.

## **⚠ WARNING!**

If Bluetooth is turned off or App is not permitted to access Bluetooth, the product cannot be paired. (Note: Even if Bluetooth is turned on, it does not mean the APP is allowed to access your Bluetooth.)

## **Note:**

- The product can only be paired to one account at a time. If another user pairs their smartphone to the product, the previous account will lose their control of the product.
- User who has already been paired can share their control rights with other users. For details, see “E. Sharing Control”.

## **Note:**

If APP cannot find the product, or during Pairing Sequence, if APP shows an exclamation mark icon, it means pairing is unsuccessful. Please use method 2 below for pairing.

# Operation Instructions

## Method 2: Bluetooth Pairing

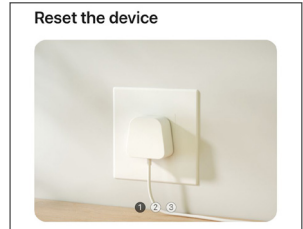
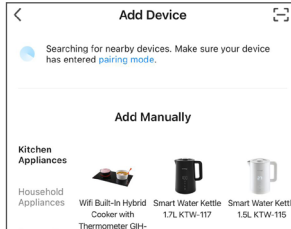
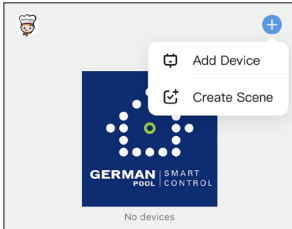

1. Click “+” on the upper right corner of the APP homepage, then click “Add Device”.

2. In the “Add Manually “ column, find the product model that needs to be paired, and click the product to pair.

3. Follow the instructions on the APP to pair.

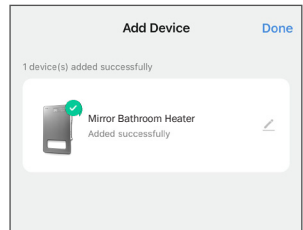
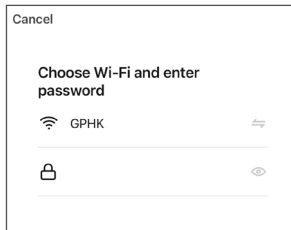
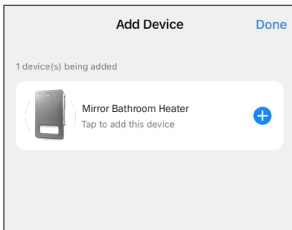

4. Click “+” on the right of product name.

5. Select WiFi name and enter your WiFi password, then click “Next”.

6. When pairing is completed, APP will show “Added successfully”. Click “Done” to return to homepage.

### ⚠ WARNING!

If Bluetooth is turned off or App is not permitted to access Bluetooth, the product cannot be paired. (Note: Even if Bluetooth is turned on, it does not mean the APP is allowed to access your Bluetooth.)

# Operation Instructions

## E. Sharing Control

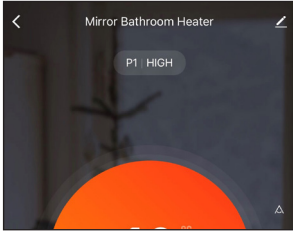

1. On the product's homepage, click “” on the upper right corner.

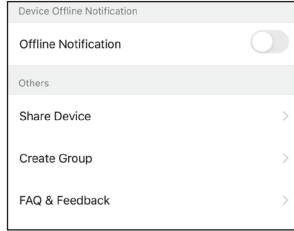

2. Click “Share Device” under “Others”.

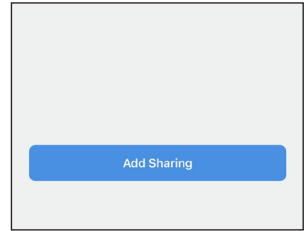

3. Click “Add Sharing”.

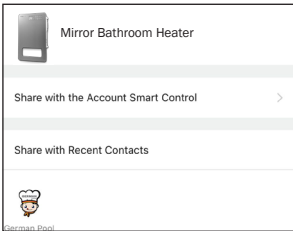

4. Set the number of users with whom you wish to share control, then click “Share with the Account Smart Control”.

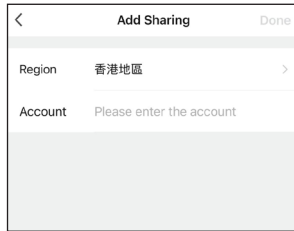

5. Enter that account's registered email address, then click “Done” on the upper right corner.

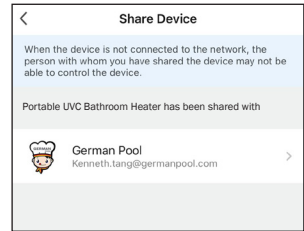

6. Repeat step 3-5 to share with more accounts.

### Note:

On the “Share Device” page, you can add or delete other accounts' control rights.

# Operation Instructions

## Using The App

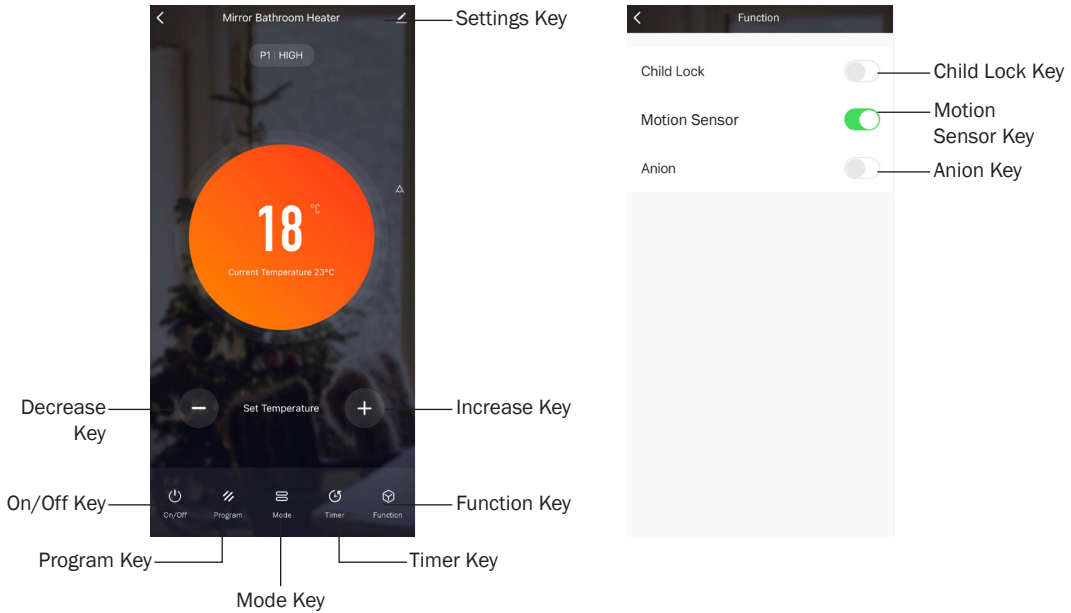

| Key               | Description  |
|-------------------|--|
| On/Off Key        | Tap to turn product on or off                                  |
| Program Key       | Tap to select Preset Weekly Program P1-P5                      |
| Mode Key          | Tap to select High, Low or Quiet mode                          |
| Timer Key         | Tap to select 1-24 hr off timer                                |
| Function Key      | Tap to enter Child Lock, Motion Sensor and Anion function page |
| Decrease Key      | Tap to decrease target temperature                             |
| Increase Key      | Tap to increase target temperature                             |
| Child Lock Key    | Tap to turn child lock function on or off                      |
| Motion Sensor Key | Tap to turn motion sensor function on or off                   |
| Anion Key         | Tap to turn anion function on or off                           |

# Cleaning & Maintenance

## **⚠ WARNING!**

Before cleaning and maintenance, turn off the product and unplug the power plug first. DO NOT immerse this product in water and DO NOT splash water on it.

### **Cleaning The Surface**

Clean the surface of the product with a wrung out soft cloth. DO NOT immerse, rinse or wet product directly with water. DO NOT use gasoline, thinner, or corrosive cleaners or solvent.

### **Cleaning The Filter**

If too much foreign matter adheres to the mesh filter, it will affect the air outlet performance, so it should be cleaned at least every other month.

1. Remove the mesh filter from the back casing of the product, and use vacuum cleaner to vacuum off any accumulated dust.
2. If mesh filter is too dirty, rinse it in water and diluted neutral detergent, then allow it to completely air dry before installing it back.

### **Maintenance**

1. If the product won't be used for a long time, pull out the power plug, pack the heater to prevent dust from entering it.
2. Before packing, make sure that the outer surface and the filter are dry.
3. After packaging, it should be stored in a dry and ventilated place away from direct sunlight.

### **Changing Battery For Remote Control**

1. To open the battery cover at the bottom of the remote control, press the buckle on the battery cover inward and pull it out.
2. Identify the polarity of the battery, and insert the battery into the battery slot.
3. Reinsert the battery cover into the bottom of the remote control.

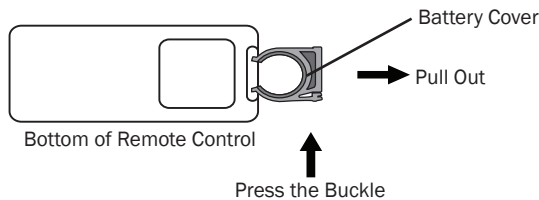

## **⚠ WARNING!**

This product contains a coin / button cell battery. If the coin / button cell battery is swallowed, it can cause severe internal burns in just 2 hours and can lead to death. Keep new and used batteries away from children.

# Troubleshooting

---

| Error Code | Problem                        | Solution   |
|------------|--------------------------------|--|
| E1         | Sensor short circuit           | Contact German Pool Customer Service & Repair Centre           |
| E2         | Sensor open circuit            | Contact German Pool Customer Service & Repair Centre           |
| E3         | Temperature too high (> 50 °C) | Use this product in a suitable ambient temperature environment |
| E4         | Temperature too low (< -40 °C) | Use this product in a suitable ambient temperature environment |

# Technical Specification

---

|                     |                            |
|---------------------|----------------------------|
| <b>Model</b>        | <b>HTW-M20-SC</b>          |
| Voltage / Frequency | 220-240 V ~ 50 Hz          |
| Power               | 2000 W                     |
| Product Dimensions  | (H) 535 (W) 340 (D) 110 mm |
| Net Weight          | 4.16 kg                    |
| Protection Rating   | IP24*                      |

\*IP24 protection rating only applies to wall-mounted installation.

- Specification is subject to change without prior notice.
- If there is any inconsistency or ambiguity between the English version and the Chinese version, the Chinese version shall prevail.
- Refer to [www.germanpool.com](http://www.germanpool.com) for the most update version of the user manual.



# 目錄

---

警告及注意事項 26

產品結構 28

安裝說明 29

使用說明 32

清潔與保養 45

故障檢修 46

技術規格 46

保用條款 47

# 警告及注意事項

## 注意：

- IP24防水防塵級別只適用於掛牆安裝。
- 本產品不可作風扇用途。

## ⚠ 警告！

使用本產品前，請仔細閱讀所有說明。

- 本產品只限家居室內日常使用，如產品作任何商業、工業、出租或其他用途，保用證即告失效。
- 請勿讓兒童或身體有殘障、精神不健全及對本產品缺乏經驗或知識的人士單獨使用本產品；如需使用，必須要在負責任的成年人監管下方可使用。
- 應照顧好兒童，確保他們不會玩耍本產品。
- 無成年人監管下，勿讓兒童清潔及維護本產品。
- 使用前，請先檢查所有電壓是否與本產品標籤上的電壓相符。
- 如果電源線損壞，為免發生意外，電源線必須由廠方、廠方指定的維修中心或同等合格的技术人員進行更換。
- 清潔或檢查本產品前，必須先關機及拔掉插頭。
- 請聯繫德國寶授權的技术人員進行維修或保養本產品。

1. 使用本產品前，請仔細閱讀所有說明。
2. 使用前，請先檢查所用電壓是否與本產品標籤上的電壓相符。
3. 當本產品由8歲或以上兒童、感官或精神有缺陷、及缺乏必要經驗和知識的人使用時，必須有對其安全負責的人進行監管，並確保使用者的安全及其明白當中潛在危險。當兒童對本產品進行清潔和維護時，必須有對其安全負責的人進行監管。
4. 3歲以下的幼兒應遠離本產品，除非有對其安全負責的人進行持續監管。
5. 當本產品被放置或安裝在正常工作位置時、在有對其安全負責的人的指導或協助、並確保使用者的安全及其明白當中潛在危險的前提下，3至8歲的兒童只可開啟/關閉本產品。3至8歲的兒童不可調節、清潔、保養本產品，亦不可把本產品插頭連接電源。
6. ⚠ **警告！** 本產品的某些部分可能變得非常熱並導致燒傷，兒童和弱勢群體在場時請特別注意。
7. 本產品不適用於身體、感官或精神有缺陷，及缺乏必要經驗和知識的人群（包括小孩），除非在能對其安全負責的人的監管下使用。
8. 兒童應進行監管，以確保他們不玩耍本產品。
9. ⚠ **警告！** 為避免過熱，禁止覆蓋本產品。
10. 在浴缸、花灑、噴頭或泳池的四周不得使用本產品。
11. 如果本產品有跌落過，請勿使用。
12. 本產品不得直接置於電源插座下面。
13. 如果本產品有明顯的損壞跡象，請勿使用。
14. 如果電源軟線損壞，為了避免危險，必須由製造商、其維修部或類似部門的專業人員更換。
15. 在水平和穩定的表面上使用本產品。（注意：安裝後本產品底部必須距離地面1-1.8米，距離牆壁大於0.3米，如在浴室使用，必須垂直安裝，並確保安裝位置離水源的距離大於1米）。

# 警告及注意事項

---

16. ⚠ **警告！**當小房間內有無法自行離開房間的人員時，請勿在小房間內使用本設備，除非提供持續的監督。
17. ⚠ **警告！**為了避免對年幼兒童造成危險，該設備的安裝應確保最低加熱面至少高出地板1米。
18. 本產品的擺放應確保開關和其他控制裝置不會被沐浴或淋浴的人觸及。
19. 本產品僅供家用和室內使用。
20. 不能用濕手觸摸開關和控制面板。
21. 對於附加保護，建議在浴室供電電路中安裝額定工作電流不超過30mA的過流保護裝置（RCD）。請向安裝人員諮詢。
22. 本產品僅用於烘乾水洗過的紡織品。
23. 應保護電器插頭，例如遠離水源，或用防水盒保護插頭。
24. 不要攝入電池，可能導致化學灼傷危險。
25. ⚠ **警告！**本產品包含鈕扣電池。如果鈕扣電池被吞下，可能在2小時內造成嚴重的內部燒傷，並可能導致死亡。
26. 新電池和舊電池應遠離兒童。
27. 如果電池蓋不能安全關閉，請停止使用遙控器，並將其遠離兒童。
28. 如果您認為電池可能被吞食或放置在身體任何部位，請立即就醫。
29. 電池含有對環境有害的材料；在報廢前，必須將其從設備中取出，並進行安全處理。
30. ⚠ **警告！**為避免引起火警，出風口1米範圍內，嚴禁擺放任何布料、窗簾或其他易燃物料。

# 產品結構

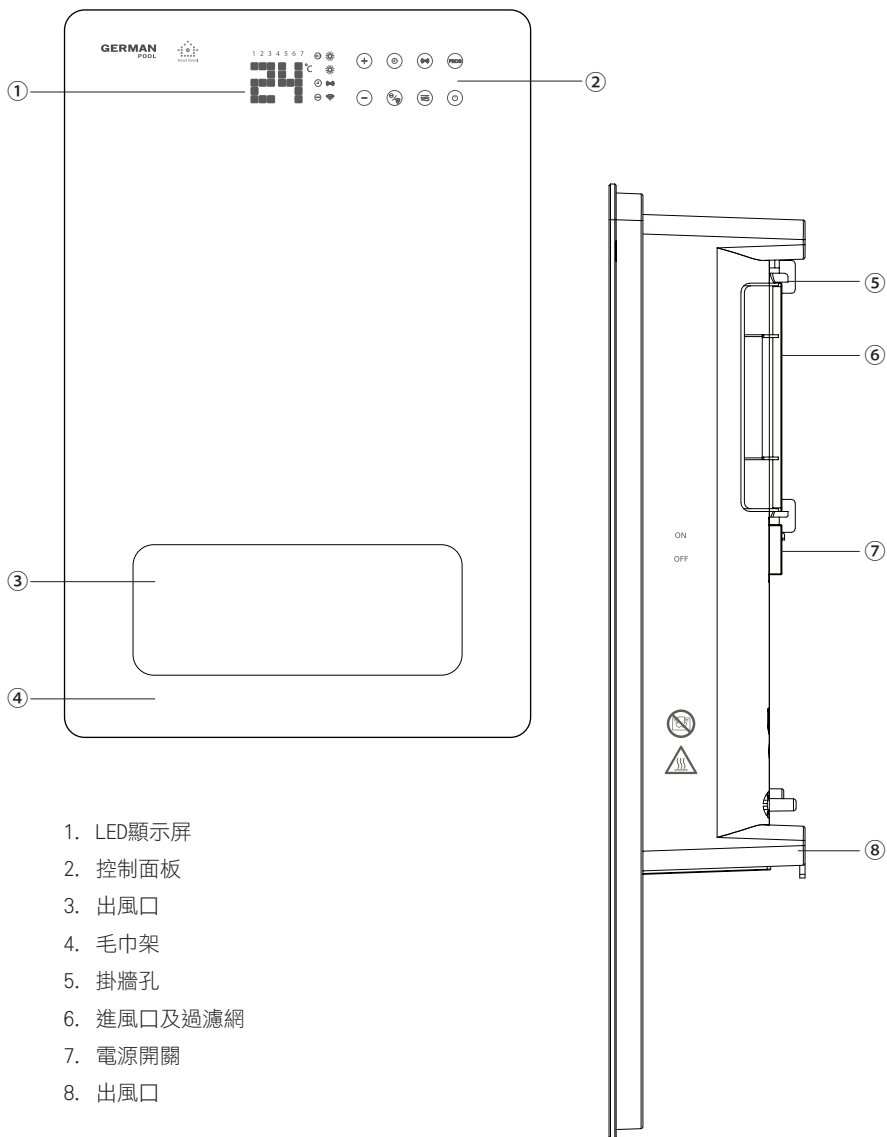

# 安裝說明

## 安全注意事項

### 掛牆安裝

要符合IP24防水防塵級別，本產品必須掛牆安裝。如果在浴室使用，請確保安裝位置離水源的距離大於1米。

### ⚠ 警告！

請確保該安裝距離滿足下圖要求：

1. 頂部距離應不少於500mm。
2. 側壁距離應不少於300mm。
3. 地面距離應為至1,000-1,800mm。

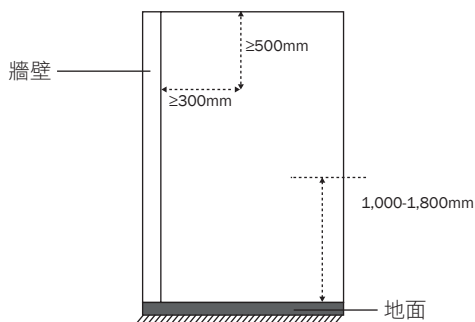

### ⚠ 警告！

- 本產品不得安裝在區域1或2（如下圖）。
- 安裝時必須確保開關和其他控制裝置不會被沐浴或淋浴中的人觸摸。

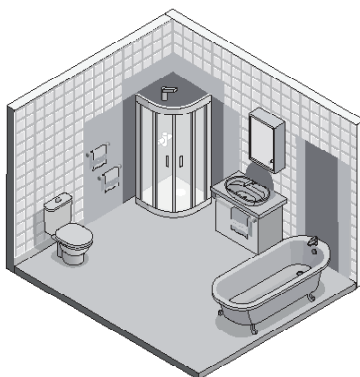
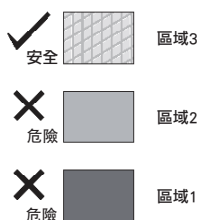

# 安裝說明

## 安裝步驟

1. 按圖示尺寸在安裝的承重牆上打3個 $\text{\O}6$ 的孔。

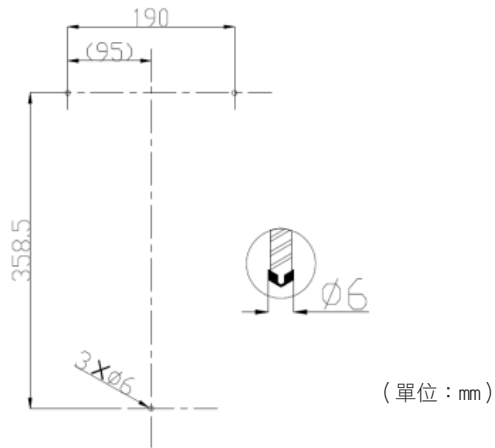

2. 將三顆膨脹膠塞打進孔內。分別用兩顆 $\text{ST4}\times\text{35}$ 的大扁頭自攻螺絲，擰入頂部的兩顆膨脹膠塞內（注意：螺絲頭與牆的距離必須留4mm的間隙）。

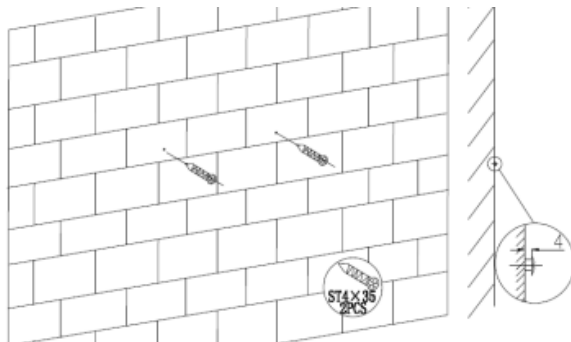

# 安裝說明

3. 將本產品後殼的掛牆孔掛進牆上的兩顆螺絲上，然後往下輕拉，確保安裝到位及穩固。

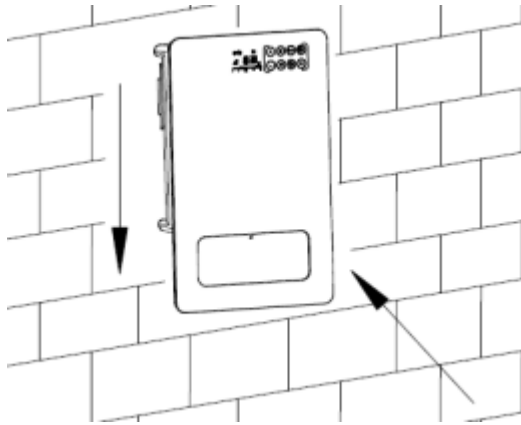

4. 將 1 顆ST4\*35的大扁頭自攻螺絲，穿過機背底部的螺絲孔擰入膨脹膠粒內，將本產品完全固定。



# 使用說明

## 控制面板

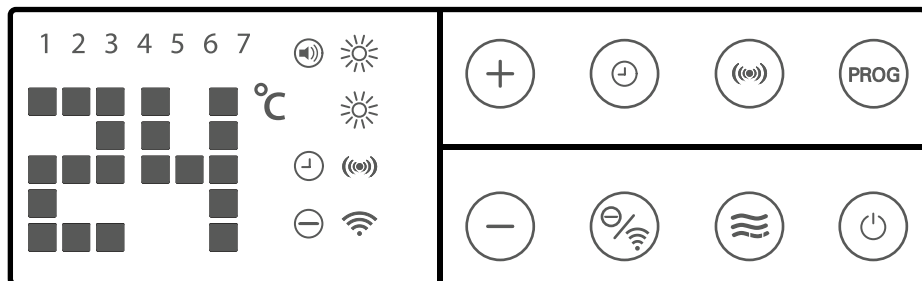

| LED 顯示屏       |          | 控制按鍵 (遙控相同) |           |
|---------------|----------|-------------|-----------|
| 1 2 3 4 5 6 7 | 星期顯示     |             | 加鍵        |
|               | 溫度/時間顯示  |             | 減鍵        |
|               | 溫度指示燈    |             | 時鐘/定時鍵    |
|               | 時鐘/定時指示燈 |             | 負離子/WiFi鍵 |
|               | 靜音模式指示燈  |             | 人體感測鍵     |
|               | 高/低檔指示燈  |             | 模式鍵       |
|               | 人體感測指示燈  |             | 程式鍵       |
|               | 負離子指示燈   |             | 開關鍵       |
|               | WiFi 指示燈 |             |           |



# 使用說明

---

## 遙控器

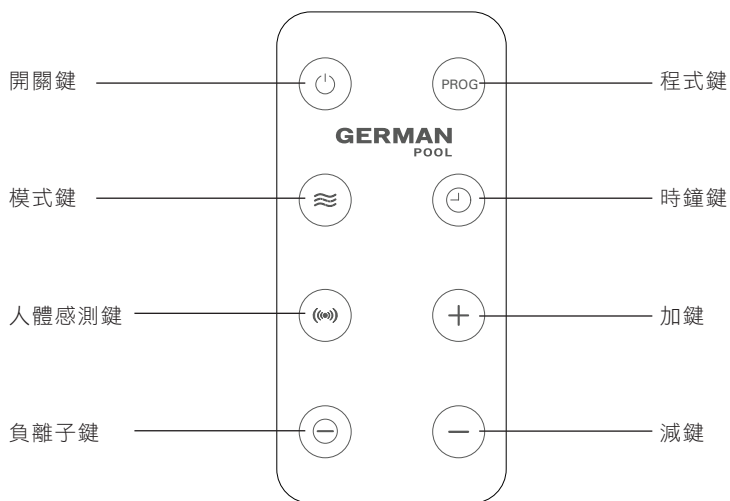

# 使用說明

## A. 基本操作

### 注意：











- 使用控制面板按鍵與遙控器按鍵的操作相同。  
(「設置當前星期和時間」、「定時關機功能」及WiFi連接無法使用遙控器進行操作。)
- 使用遙控器操作時，需將遙控器對準LED顯示屏，令遙控信號達到最好。

### A1. 設置當前星期和時間（初次使用）

1. 插上電源後，按機背的電源鍵開機，蜂鳴器發出聲響兩聲，所有功能鍵亮起，顯示屏上的「溫度/時間顯示」顯示當前室溫，產品進入待機狀態。在待機狀態下，按「開關鍵 」開機。

### 注意：



如產品在10秒內無任何操作，顯示屏所有燈熄滅（除卻溫度/時間顯示及開關鍵仍亮起）。按任意鍵，所有功能鍵會重新亮起。

2. 開機後，長按「時鐘/定時鍵 」3秒進入「當前星期和時間設置」。
3. 按「加鍵 」或「減鍵 」選擇當前日子（1-7對應星期一至星期日），按「時鐘/定時鍵 」確認。
4. 按「加鍵 」或「減鍵 」選擇當前小時（00-23對應凌晨12時至晚上11時），按「時鐘/定時鍵 」確認。
5. 按「加鍵 」或「減鍵 」選擇當前分鐘（00-59），按「時鐘/定時鍵 」確認。
6. 設定時鐘後，「溫度/時間顯示」會顯示當前室內溫度。

### 注意：

檢視當前時間：產品運行期間，按「時鐘/定時鍵 」一次，「溫度/時間顯示」會顯示當前小時2秒，再顯示分鐘2秒，然後回復顯示當前溫度。

### A2. 開機 / 關機

1. 開機：在待機狀態下，按任意鍵喚醒控制面板，然後按「開關鍵 」開機，產品會按上次開機前的設置運行。
2. 關機：產品運行期間，按「開關鍵 」關機。產品會立即停止加熱，散熱風扇會延遲30秒停止運行，產品返回待機狀態。





### 注意：

如果產品在運作但控制鍵已熄滅，需先按任意鍵喚醒控制面板後，再按「開關鍵 」關機。





### A3. 高檔 / 低檔 / 靜音模式

1. 連接電源，產品進入待機狀態，蜂鳴器發出聲響兩聲，顯示屏顯示當前室溫及當前星期時間。
2. 按「開關鍵 」開機。如首次使用，產品預設目標溫度24°C及高檔模式，指示燈常亮，「溫度/時間顯示」顯示當前室溫。

# 使用說明

3. 按「模式鍵」 循環選擇低檔/靜音模式/高檔。
4. 要調節目標溫度，可按「加鍵」 或「減鍵」，每次按鍵上升或減低1°C。長按加減鍵可加快調節速度。
5. 如要關機，按「開關鍵」 關機，產品即回復待機狀態。





## A4. 設置目標溫度

1. 產品運行期間，按「加鍵」 或「減鍵」 進入溫度設置，「溫度/時間顯示」顯示當前設定溫度。再按「加鍵」 或「減鍵」 增加或減低目標溫度於5°C-40°C之間。
2. 設置目標溫度後，產品會自動確認設置，5秒後「溫度/時間顯示」會顯示當前室溫。

### 注意：

- 如果產品正運行「防凍模式」正在運行，目標溫度不可調。必須先按「程式鍵」 關閉「防凍模式」。（詳見「B. 進階操作」）
- 產品達到目標溫度後會自動停止加熱；當室內溫度下降至目標溫度以下1°C，產品會重新加熱。

## A5. 定時關機功能

1. 按「時鐘/定時鍵」 2次進入「定時關機設置」，產品預設「溫度/時間顯示」閃爍「0」，「時鐘/定時指示燈」閃爍。
2. 按「加鍵」 或「減鍵」 調校定時關機（0-24小時）；完成設置後，產品會在5秒後自動確認設置，「溫度/時鐘指示燈」常亮，產品開始進入倒數。
3. 要取消定時關機功能，再按「時鐘/定時鍵」 2次。

### 注意：

- 倒數期間，「溫度/時鐘顯示」會交替顯示當前溫度及倒數時間。
- 「定時關機功能」只有在P1程式下方可使用。P2至P5程式並不支援個人設置定時關機。（詳見「B. 進階操作」）

# 使用說明





## B. 進階操作

### 一周預設程式

本產品內置預設一周程式P1-P5，依據所選程式在指定時間運行「舒適模式」（由用戶設定溫度及高/低/靜音模式）或防凍模式。（固定為5°C，不可自行設定）

P1：全日程式 / P2：家庭程式 / P3：辦公室程式 / P4：商場程式 / P5：防凍程式

| 程式 | 星期幾 | 舒適/防凍模式運行時間  | 適合用戶                   |
|----|-----|--|------------------------|
| P1 | 1-7 | 00:00-24:00 舒適模式   | 適合日常使用                 |
| P2 | 1-5 | 00:00-06:30 防凍模式/休眠<br>06:30-08:30 舒適模式<br>08:30-17:00 防凍模式/休眠<br>17:00-22:30 舒適模式<br>22:30-24:00 防凍模式/休眠  | 適合星期一至五上班，周末在家的家庭      |
|    | 6-7 | 00:00-07:30 防凍模式/休眠<br>07:30-10:00 舒適模式<br>10:00-12:00 防凍模式/休眠<br>12:00-14:00 舒適模式<br>14:00-17:00 防凍模式/休眠<br>17:00-22:30 舒適模式<br>22:30-24:00 防凍模式/休眠 |                        |
| P3 | 1-5 | 00:00-06:00 防凍模式/休眠<br>06:00-17:00 舒適模式<br>17:00-24:00 防凍模式/休眠   | 適合星期一至五正常時間開放、周末關閉的辦公室 |
|    | 6-7 | 00:00-24:00 防凍模式   |                        |
| P4 | 1-7 | 00:00-06:00 防凍模式/休眠<br>06:00-22:00 舒適模式<br>22:00-24:00 防凍模式/休眠   | 適合全周開放的商業場所            |
| P5 | 1-7 | 00:00-24:00 防凍模式/休眠  | 適合長時間沒有人的場所（例如外遊的家庭）   |

1. 產品運行期間，重覆按「程式鍵 」循環選擇P1-P5。選擇完成3秒後產品會自動確認設置，「溫度/時間顯示」顯示當前溫度。
2. 在P1程式下，全日任何時段皆為「舒適模式」，用戶可自行設置溫度、高/低/靜音模式、定時關機功能；在P2-P5程式下，只有上表所列的「舒適模式」時段期間用戶才可自行調節各項設定，在「防凍模式」運行期間產品則固定以5°C目標溫度運行，不可更改。
3. 在使用P2-P5程式期間，可按「開關鍵 」進行手動關機，產品將暫時退出一周預設程式；再按「開關鍵 」，手動開機後，產品將繼續以關機前的所選程式運行。
4. 如要退出一周預設程式，按「程式鍵 」選擇P1即可。

### 注意：

「防凍模式」專為氣候寒冷地區而設，目的在於讓本產品在嚴寒下避免處於冷凍狀態，因此「防凍模式」下產品固定以5°C目標溫度運行：

- 如室內溫度低於5°C，本產品將恆溫製暖，將室內溫度提升至5°C。
- 如室內溫度高於5°C，本產品將關閉「防凍模式」，並自動休眠。

# 使用說明



## 斷電記憶功能

1. 產品斷電即停止運行。回復供電後，產品進入待機狀態。按「開關鍵 」重新開機，產品默認為斷電前所設置的資料。
2. 如果斷電前，產品是設置成「靜音模式」，回復供電後，產品會先以高檔模式運行15秒，再回復至「靜音模式」。



### 注意：

斷電後，功能和時間設定只會儲存72小時，如72小時內不回復供電，用戶需重置當前星期和時間。





## 人體感測功能

- 產品運行期間，按「人體感測鍵 」啟動此功能。啟動功能後，每次產品感測到動態，「人體感測指示燈」會亮起，產品自動加熱；如15分鐘內再沒有任何動態，產品停止加熱，「溫度/時間顯示」顯示當前溫度，所有其他指示燈及功能鍵熄滅。
- 再按「人體感測鍵 」一次關閉此功能，「人體感測指示燈」熄滅。

## 負離子功能

- 產品運行期間，按「負離子/WiFi鍵 」啟動負離子淨化功能，「負離子指示燈」常亮。
- 再按「負離子/WiFi鍵 」一次關閉此功能，「負離子指示燈」熄滅。

## 童鎖功能

- 產品運行期間，同時長按「加鍵 」和「減鍵 」3秒啟動「童鎖功能」，「溫度/時間顯示」顯示[ ]5秒然後重新顯示原先設置狀態，所有按鍵無效。
- 再長按「加鍵 」和「減鍵 」3秒關閉此功能。

## 恢復出廠設置

產品運行中，同時按「加鍵 」和「減鍵 」兩次，產品即回復到出廠設置（預設高檔/24°C）。

# 操作說明

## 使用WiFi連接本產品

本產品可透過德國寶智能控制應用程式「German Pool Smart Control」APP以智能手機操控。

### 注意：

必須使用頻率為2.4 GHz的WiFi進行連接，不適用於頻率為5.0 GHz的WiFi。

### A. 下載應用程式

連接頻率為2.4 GHz的WiFi後，掃描下方二維碼，或於蘋果iOS系統上的App Store或安卓Android系統上的 Google Play搜尋「German Pool Smart Control」，下載並安裝APP。



蘋果iOS系統  
App Store



安卓Android系統  
Google Play

### B. 設置APP語言

#### 蘋果iOS系統

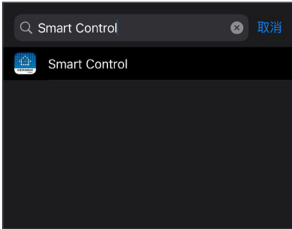

1. 在手機的設定中搜尋「Smart Control」。



2. 點擊「偏好的語言」。

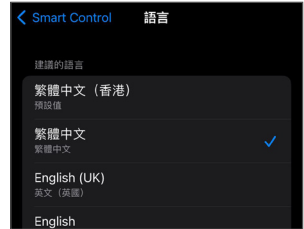

3. 在「建議的語言」一欄中選擇繁體中文或英文（注意：選擇「繁體中文(香港)」APP將會顯示英文）。

#### 安卓Android系統

預設為系統所使用的語言，如需更改APP語言，需在設置中更改系統語言。

# 操作說明

## C. 註冊用戶資料

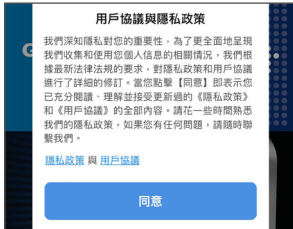

1. 打開APP，點擊「用戶協議與隱私政策」上的「同意」。
2. 點擊「註冊」註冊用戶資料。
3. 輸入電郵地址，剔選「我同意隱私政策與用戶協議」後點擊「獲取驗證碼」。



4. 輸入電郵裡的驗證碼。
5. 設定您的登入密碼後點擊「完成」，完成註冊。

# 操作說明

## D. 配對本產品

### 方法1：自動配對

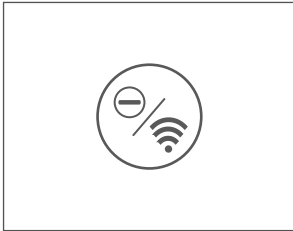

1. 長按暖風機上的「負離子/WiFi鍵」5秒，直至蜂鳴器發出提示聲，WiFi指示燈閃爍。



2. 點擊APP主頁右上角「+」，再點擊「添加設備」。



3. 配對前必須先打開藍牙權限，點擊「打開藍牙」（如已打開，可忽略此步驟）。



4. 點擊「去設定」（如已打開，可忽略此步驟）。

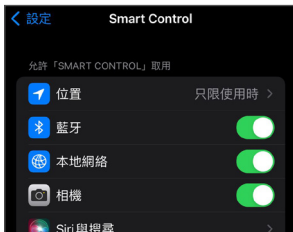

5. 點擊藍牙一欄以打開藍牙權限（如已打開，可忽略此步驟）。



6. APP顯示「正在搜索附近的設備...」。



7. 數秒後APP顯示「發現設備...」，點擊「添加」。



8. 點擊產品名稱右方的「+」。



9. 配對時建議開啟位置權限，點擊「立即設置」（如已開啟，可忽略此步驟）。



# 操作說明

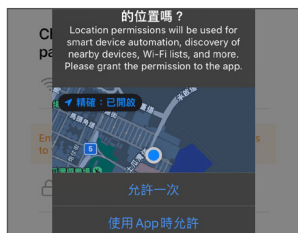

10. 點擊「使用APP時允許」（如已開啟，可忽略此步驟）。



11. 輸入手機所連接的WiFi名稱及密碼，點擊「下一步」。



12. APP顯示「正在添加」，產品與APP自動配對中。



13. 配對完成後APP顯示「添加成功」，按右上角「完成」進入產品主界面。

## ⚠ 警告！

如沒有開啟藍牙或沒有打開藍牙權限，將無法配對產品；注意，即使電話已開啟藍牙功能，並不代表已打開「藍牙權限」。

## 注意：

- 每次只可以一個帳戶進行配對，如由另一帳戶再次進行配對，先前已配對的帳號將失去本產品的操作權。
- 已配對的帳戶可以分享本產品的操作權予其他帳戶，詳見「E. 操作權分享」部份。

## 注意：

如無法搜索到本產品，或在配對期間APP顯示感嘆號符號，代表配對失敗，請使用下列的方法2進行配對。

# 操作說明

## 方法2：藍牙配對



1. 點擊APP主頁右上角「+」，再點擊「添加設備」。



2. 在「手動添加」一欄找到需要配對的產品型號，點擊該產品進行配對。



3. 按照APP上的指示進行配對。



4. 點擊產品名稱右方的「+」。



5. 輸入手機所連接的Wi-Fi名稱及密碼，點擊「下一步」。



6. 配對完成後APP顯示「添加成功...」，按右上角「完成」進入產品主界面。

### ⚠ 警告！

如沒有開啟藍牙或沒有打開藍牙權限，將無法配對產品；注意，即使電話已開啟藍牙功能，並不代表已打開「藍牙權限」。

# 操作說明

## E. 操作權分享

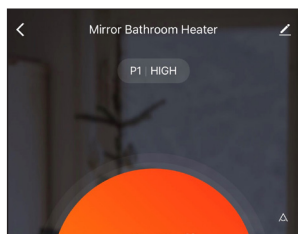

1. 在本產品操作主界面點擊右上角「」。



2. 在「其他」一欄中點擊「共用設備」。



3. 點擊下方「添加共用」。

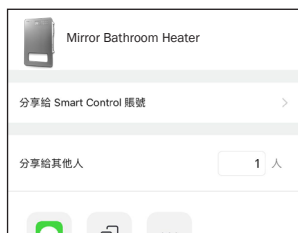

4. 在「分享給其他人」一欄中可設定所需分享的人數，再點擊「分享給 SmartControl賬號」。



5. 輸入該帳戶的註冊電郵地址，再點擊右上角「完成」即可。



6. 重複步驟3-5添加更多其他帳戶。

### 注意：

在「共用設備」頁面裡，你可隨時添加或移除帳戶的操作權。

# 操作說明

## 使用APP操作

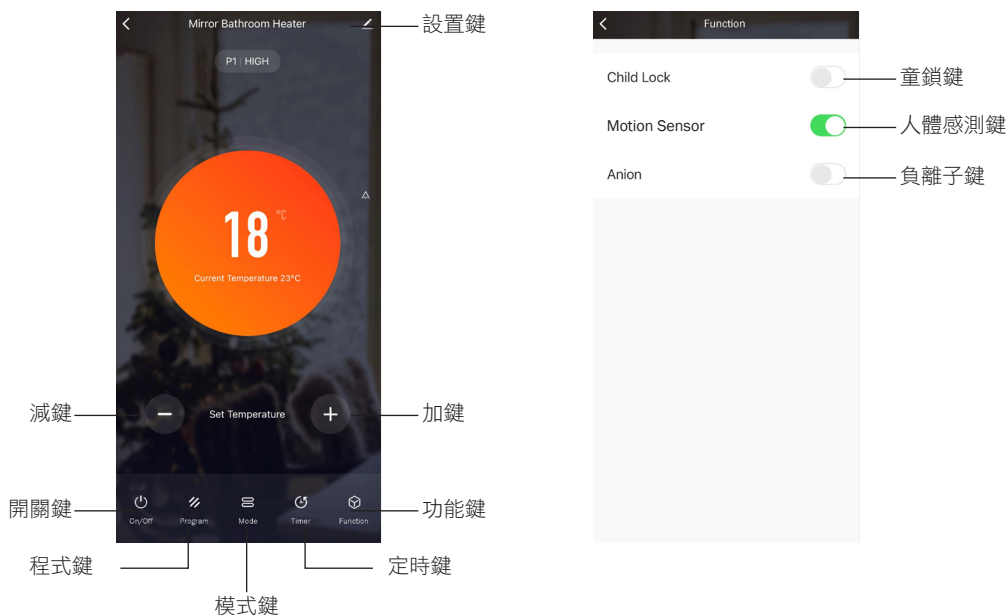

| 按鍵    | 說明                           |
|-------|------------------------------|
| 開關鍵   | 按此鍵開機或關機                     |
| 程式鍵   | 按此鍵選擇一周預設程式P1-P5             |
| 模式鍵   | 按此鍵選擇「高檔」、「低檔」或「靜音模式」        |
| 定時鍵   | 按此鍵選擇1-24小時定時關機              |
| 功能鍵   | 按此鍵進入「童鎖」、「人體感測」及「負離子」功能設置頁面 |
| 減鍵    | 按此鍵減低溫度                      |
| 加鍵    | 按此鍵提升溫度                      |
| 童鎖鍵   | 按此鍵開啟或關閉童鎖功能                 |
| 人體感測鍵 | 按此鍵開啟或關閉人體感測功能               |
| 負離子鍵  | 按此鍵開啟或關閉負離子功能                |

# 清潔與保養

## ⚠ 警告！

清潔與保養前，必須先關機並拔掉拔頭。  
禁嚴將本產品浸於水中或向機身淋水。

## 機身表面清先

機身表面清潔，應用扭乾軟布抹拭。嚴禁將機身浸水、以水沖洗或潑濕。嚴禁使用汽油、天拿水、稀釋劑或有腐蝕性的洗滌劑、溶劑之類進行清潔。

## 過濾網清洗

若過濾網上附著過多的異物，將影響出風效果，因此應至少每隔一個月清洗一次。

1. 將機身背面的濾網拆下，用吸塵機吸除濾網上的灰塵。
2. 如濾網太髒，可以清水及稀釋中性清潔劑清洗，然後讓其完全風乾後重新裝上。

## 維護保養

1. 當產品長期不使用時，應拔下電源插頭，包裝好本機以防止灰塵進入機體。
2. 包裝前應確保產品表面、過濾網等是乾燥的。
3. 包裝好後應放置於遠離陽光照射的乾燥通風處存放。

## 更換遙控器電池

1. 向內按住遙控器底部電池槽上的扣位，電池槽往外拉出。
2. 確認電池的極性，將電池裝進電池槽的凹槽內。
3. 將電池槽裝回遙控器的底部。

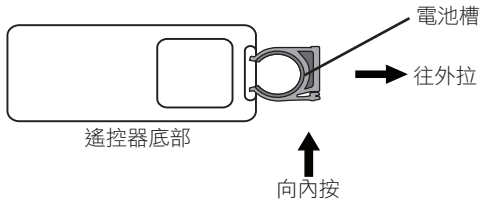

## ⚠ 警告！

本產品包含鈕扣電池。如果鈕扣電池被吞下，可能在2小時內造成嚴重的內部燒傷，並可能導致死亡。新電池和舊電池應遠離兒童。

# 故障檢修

| 故障代碼 | 可能原因             | 解決方法           |
|------|------------------|----------------|
| E1   | 傳感器短路            | 聯絡德國寶客戶服務及維修中心 |
| E2   | 傳感器開路            | 聯絡德國寶客戶服務及維修中心 |
| E3   | 超高溫顯示 (> 50 °C)  | 在適當溫度環境下使用本產品  |
| E4   | 超低溫顯示 (< -40 °C) | 在適當溫度環境下使用本產品  |

# 技術規格

|           |                            |
|-----------|----------------------------|
| <b>型號</b> | <b>HTW-M20-SC</b>          |
| 電壓 / 頻率   | 220-240 V ~ 50 Hz          |
| 功率        | 2000 W                     |
| 產品尺寸      | (H) 535 (W) 340 (D) 110 mm |
| 淨重        | 4.16 kg                    |
| 防水防塵級別    | IP24*                      |

\* P24防水防塵級別只適用於掛牆安裝。

- 產品規格及設計如有變更，恕不另行通知。
- 中英文版本如有出入，一概以中文版為準。
- 本產品使用說明書以[www.germanpool.com](http://www.germanpool.com)網上版為最新版本。

# 保用條款

# Warranty Terms & Conditions

此保用提供德國寶產品之機件在正常使用下壹年保用(自購買日起計算)。

Under normal operations, the product will guarantee a 1-year full warranty provided by German Pool (effective from the date of purchase).

\*貴戶須在購機十天內，以下列其中一種方式向本公司登記資料，保用手續方正式生效：

- 1) 填妥德國寶VIP手機應用程式保用登記表(掃描右方二維碼)
- 2) 填妥本公司網頁保用登記表  
[www.germanpool.com/warranty](http://www.germanpool.com/warranty)
- 3) 填妥保用卡郵寄至本公司



\* This warranty is not valid until customer registration information is received by our Service Centre within 10 days of purchase via one of the following means:

- 1) Visit our VIP App and register online:  
(Scan the QR Code on the right)
- 2) Visit our website and register online:  
[www.germanpool.com/warranty](http://www.germanpool.com/warranty)
- 3) Complete the attached Warranty Card and mail it back to our Customer Service Centre.



另請填妥以下表格並與正本發票一併保存，以便維修時核對資料。用戶提供之所有資料必須正確無誤，否則免費保用將會無效。Please fill out the form below. This information and the original purchase invoice will be required for any repairs. Warranty will be invalidated if information provided is found to be inaccurate.

型號 Model No. : HTW-M20-SC

機身號碼 Serial No. : \_\_\_\_\_

購買商號 Purchased From : \_\_\_\_\_

發票號碼 Invoice No. : \_\_\_\_\_

購買日期 Purchase Date : \_\_\_\_\_

1. 未能出示購買發票正本者，將不獲免費維修服務。
2. 用戶應依照說明書的指示操作。本保用並不包括：
  - 上門安裝、檢驗、維修或更換零件之人工以及一切運輸費用；
  - 因天然與人為意外造成的損壞(包括運輸及其他)；
  - 電源接合不當、不依說明書而錯誤或疏忽使用本機所引致之損壞。
3. 於下列情況下，用戶之保用資格將被取消：
  - 購買發票有任何非認可之刪改；
  - 產品被用作商業或工業用途；
  - 產品經非認可之技術人員改裝或加裝任何配件；
  - 機身編號被擅自塗改、破壞或刪除。
4. 總代理有權選擇維修或更換配件或其損壞部份。
5. 產品一經被轉讓，其保用即被視作無效。

1. Customer who fails to present original purchase invoice will not be eligible for free warranty service.
2. Customer should always follow the operating instructions. This warranty does not apply to:
  - labour costs for on-site installation, check-up, repair, replacement of parts and other transportation costs;
  - damages caused by accidents of any kind (including material transfer and others);
  - operating failures resulting from applying incorrect voltage, improper usage, and unauthorized installations or repairs.
3. This warranty is invalid if:
  - the purchase invoice is modified by an unauthorized party;
  - the product is used for any commercial or industrial purposes;
  - the product is repaired or modified by unauthorized personnel, or unauthorized parts are installed;
  - the serial number is modified, damaged or removed from the product.
4. German Pool will, at its discretion, repair or replace any defective part.
5. This warranty will be void if there is any transfer of ownership from the original purchaser.

## 客戶服務及維修中心

中國香港

九龍大業街59號

三湘九龍灣貨運中心地下B室

電話：+852 2773 2888

傳真：+852 2356 9798

電郵：[repairs@germanpool.com](mailto:repairs@germanpool.com)

中國澳門

澳門青洲大馬路(青洲新路)

515號美居廣場第二期1樓A座

電話：+853 2875 2699

傳真：+853 2875 2661

## Customer Service & Repair Centre

Hong Kong, China

Unit B, G/F, Sunshine Kowloon Bay

Cargo Centre, 59 Tai Yip Street,

Kowloon, Hong Kong

Tel : +852 2773 2888

Fax : +852 2356 9798

Email : [repairs@germanpool.com](mailto:repairs@germanpool.com)

Macau, China

A, 1 Andar, Mei Kui Kuong

Cheong Fase 2, No.515 Avenida

Do Conselheiro Borja Macau

Tel : +853 2875 2699

Fax : +853 2875 2661

此保用只適用於香港及澳門

This warranty is valid only in Hong Kong and Macau

## German Pool (Hong Kong) Limited

### Hong Kong, China

Room 113, Newport Centre Phase II, 116 Ma Tau  
Kok Road, Tokwawan, Kowloon, Hong Kong.  
Tel: +852 2773 2888  
Fax: +852 2765 8215

### Mainland China

8th, Xinxiang Road, Wusha Industrial Park,  
Daliang, Shunde, Foshan, Guangdong  
Tel: +86 757 2219 6888  
Fax: +86 757 2219 6809

### Macau, China

A, 1 Andar, Mei Kui Kuong Cheong Fase 2,  
No.515 Avenida Do Conselheiro Borja, Macau  
Tel: +853 2875 2699  
Fax: +853 2875 2661



香港 (S MARK)  
安全認證



中國電器/康電行業  
十大影響力品牌

CEO

CEO非凡品牌大賞



香港優質商號



香港工商業獎



最具素質  
創建品牌企業獎



香港中小企業  
最佳拍檔大獎



香港消費者推銷品牌



香港 (Q MARK)  
優質服務證書



香港名牌十年成就獎  
HONG KONG TOP BRAND TEN YEAR  
ACHIEVEMENT AWARD

© All rights reserved. Copying, reproducing or using the contents of this manual is not allowed without prior authorization from German Pool, violators will be prosecuted.