

Portable Air Conditioner

PAC-CH309
PAC-CH312



Online Warranty Registration



Please read these instructions and warranty information carefully before use and keep them handy for future reference.

USER MANUAL

Table of Contents

Warnings & Safety Precautions	03
Product Structure	05
Installation Instructions	06
Operation Instructions	10
Cleaning & Maintenance	15
Troubleshooting	16
Technical Specification	17
Warranty Terms & Conditions	31

Warnings & Safety Precautions

WARNING!

Read all instructions carefully before using this product.

- This product is for domestic indoor use only. If this product is used for any commercial, industrial, rental or other purposes, product warranty will be VOIDED.
 - This product is not intended for use by children or persons with reduced physical, sensory or mental capabilities, or lack of experience and knowledge, unless they have been given supervision or instruction concerning use of this product by an adult responsible for their safety.
 - Mind your children and DO NOT let children play with this product.
 - Cleaning and user maintenance shall not be made by children without supervision.
 - Check the voltage indicated on the rating label before using this product.
 - If the supply cord is damaged, it must be replaced by the manufacturer, its service agent or similarly qualified persons in order to avoid hazards.
 - Unplug this product from the power source before cleaning and maintenance.
 - Contact German Pool authorized service technician for repair or maintenance of this product.
1. DO NOT use means to accelerate the defrosting process or to clean, other than those recommended by the manufacturer.
 2. This product shall be stored in a room without continuously operating ignition sources (for example: open flames, an operating gas appliance or an operating electric heater.)
 3. DO NOT pierce or burn this product.
 4. Be aware that refrigerants may not contain an odour.
 5. Keep any required ventilation openings clear of obstruction.
 6. Servicing shall be performed only as recommended by the manufacturer.
 7. This product shall be stored in a well-ventilated area where the room size corresponds to the room area as specified for operation.
 8. Any person who is involved with working on or breaking into a refrigerant circuit should hold a current valid certificate from an industry-accredited assessment authority, which authorizes their competence to handle refrigerants safely in accordance with an industry recognized assessment specification.
 9. Servicing shall only be performed as recommended by the equipment manufacturer. Maintenance and repair requiring the assistance of other skilled personnel shall be carried out under the supervision of the person competent in the use of flammable refrigerants.
 10. All working procedure that affects safety means shall only be carried by competent persons.
 11. Be careful not to bump when moving to avoid leakage in the refrigeration line.
 12. This product is only suitable for indoor use, and is not suitable for other applications.
 13. Follow local grid interconnection rules while installing this product and ensure that it is properly grounded. If you have any question on electrical installation, follow the instructions of the manufacturer, and if necessary, ask a professional electrician to install it.
 14. Place this product in a flat and dry place and keep a distance of above 50cm between this product and the surrounding objects or walls.
 15. After this product is installed, ensure that the power plug is intact and firmly plugged into the power outlet, and place the power cord orderly to prevent someone from being tripped or pulling out the plug.
 16. DO NOT put any object into the air inlet and outlet of this product. Keep the air inlet and outlet free from obstructions.
 17. When drainage pipes are installed, ensure that the drainage pipes are properly connected, and are not distorted or bended.

Warnings & Safety Precautions

18. While adjusting the upper and lower wind-guide strips of the air outlet, pluck it with hands gently to avoid damaging wind-guide strips.
19. When moving this product, make sure that it is in an upright position.
20. This product must be placed away from gasoline, flammable gas, stoves and other heat sources.
21. DO NOT disassemble, overhaul and modify this product arbitrarily, otherwise it will cause a machine malfunction or even bring harm to persons and properties. To avoid danger, if a machine failure occurs, ask the manufacturer or professionals to repair it.
22. DO NOT install and use this product in the bathroom or other humid environments.
23. DO NOT pull the plug to turn off the machine.
24. DO NOT place cups or other objects on the body to prevent water or other liquids from spilling into this product.
25. DO NOT use insecticide sprays or other flammable substances near this product.
26. DO NOT wipe or wash this product with chemical solvents such as gasoline and alcohol. When you need to clean this product, you must disconnect the power supply, and clean it with a half-wet soft cloth. If the product housing is really dirty, scrub with a mild detergent.
27. This product can be used by children aged from 8 years and above and persons with reduced physical, sensory or mental capabilities if they have been given supervision or instruction concerning use of this product in a safe way and understand the hazards involved. Children shall not play with this product. Cleaning and maintenance shall not be made by children without supervision.
28. If the supply cord is damaged, it must be replaced by the manufacturer, its service agent or similarly qualified persons in order to avoid a hazard.
29. his product shall be installed in accordance with national wiring regulations.
30. ⚠ **WARNING!** This product's remote control contains batteries. If the battery is swallowed, it can cause severe internal burns in just 2 hours and can lead to death. Keep new and used batteries away from children. If the battery compartment does not close securely, stop using the remote control and keep it away from children. If you think batteries might have been swallowed or placed inside any part of the body, seek immediate medical attention. The batteries contain materials which are hazardous to the environment; they must be removed from the remote control before it is scrapped and that they are disposed of safely.
31. ⚠ **WARNING!** This product must be installed, operated and stored in a room with a floor area larger than 7m² (For PAC-CH309 only).



Correct Disposal of this product

This marking indicates that the product should not be disposed with other household wastes. To prevent possible harm to the environment or human health from uncontrolled waste disposal, recycle it responsibly to promote the sustainable reuse of material resources. To return your used device, please use the return and collection systems or contact the retailer where the product was purchased. They can take this product for environmentally safe recycling.

Product Structure

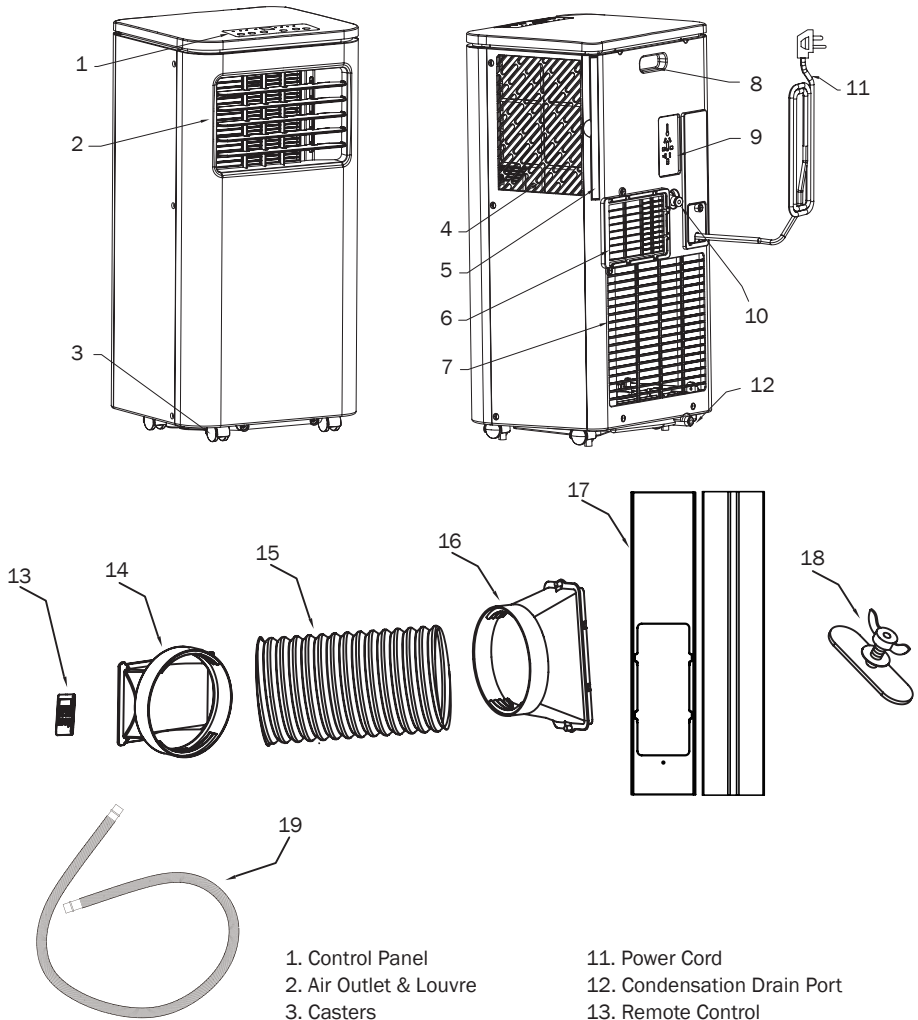

- | | |
|--------------------------------|----------------------------------|
| 1. Control Panel | 11. Power Cord |
| 2. Air Outlet & Louvre | 12. Condensation Drain Port |
| 3. Casters | 13. Remote Control |
| 4. Air Inlet | 14. Exhaust Hose Connector |
| 5. Filter | 15. Exhaust Hose |
| 6. Exhaust Hose Fastener | 16. Exhaust Hose Adaptor |
| 7. Air Inlet & Filter | 17. Window Adaptor Kit |
| 8. Handle | 18. Window Adaptor Butterfly Nut |
| 9. Power Plug Storage Slot | 19. Drain Hose |
| 10. Continuous Drainage Outlet | |

Installation Instructions

WARNING!

- Excessive Weight Hazard: It is recommended to have 2 or more persons to move and install this product. Failure to do so can result in back or other injury.
- During handling and transportation, always hold the product by the handle on the back panel, and maintain the unit in its upright position at all times.
- DO NOT move the product by gripping its louvers.
- Before moving or transporting this product, drain off the water in the unit completely to prevent water leakage wetting the floor or carpet.

Before Installation

1. This product must be placed on a firm foundation to minimize noise and vibration. For safe and secure positioning, place this product on a smooth and level floor strong enough to support this product.
2. This product has casters to aid moving it around, but it must only be rolled on smooth flat surfaces. Use caution when rolling on carpeted surfaces and hardwood floors. DO NOT roll this product over objects.
3. This product must be placed within reach of a properly rated grounded socket.

WARNING!

Electric Shock Hazard: This product must be plugged into a grounded 3-pin outlet; DO NOT pull on the cord to unplug the plug; DO NOT use an adaptor, DO NOT use with extension cord. Failure to do so can result in death, fire or electric shock.

4. DO NOT place any obstacles around the air inlet or outlet of this product.
5. The exhaust hose can be extended, but it is optimized when the hose is at its minimum length. Also make sure the hose does not have any sharp bends or sags.
6. The window adaptor kit is designed to fit most standard vertical and horizontal sliding window applications. However, it may be necessary to modify some aspects of the installation procedures for certain types of windows.

A. Remove Packing Materials

1. Remove all packing materials before using product for the first time.
2. It is recommended to save the carton box and styrofoam packing for storing the product when not in use.

Note:

- There are NO packing materials inside the product to remove. DO NOT disassemble the product body.
- Properly dispose/recycle all packing materials.
- Handle the product gently, and keep it upright and level at all times. DO NOT set this product on its side, front, back or upside down.

Installation Instructions

B. Install Exhaust Hose

1. Grasp both ends of the exhaust hose and gently pull to expand the hose.
2. Screw one end of the hose to the exhaust hose connector using a counterclockwise motion, until it is firmly attached.
3. Screw the other end of the hose to the exhaust hose adaptor using a counterclockwise motion, until it is firmly attached.

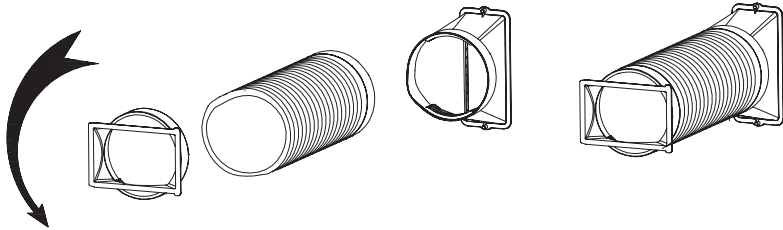

Note:

DO NOT attach additional hoses to extend the length, as it will decrease the cooling efficiency and may damage the product.

C. Connect Exhaust Hose To The Product

1. Align the exhaust host connector with the slots on the exhaust hose fastener on the back of the product.
2. Slide the connector into the exhaust hose fastener from left to right until it is firmly attached.

Installation Instructions

D. Install Window Adaptor Kit

Note:

- Window adaptor kit is designed to accommodate either a vertical slide or horizontal slide window.
- If the window opening is shorter than the minimum length of the window adaptor kit, cut the end without the hole until it is short enough to fit in the window opening. DO NOT cut out the hole in the window adaptor kit.

1. Depending on the size of your window, you may need to use the expansion panel in addition to the main adaptor panel.
2. Open the window, and place the main adaptor panel in the window opening.

Vertical Slide Window

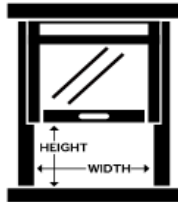

Horizontal Slide Window

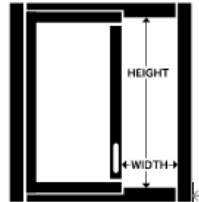

3. Take out the butterfly nut from the accessories bag, and unscrew the nut as shown in the diagram below.

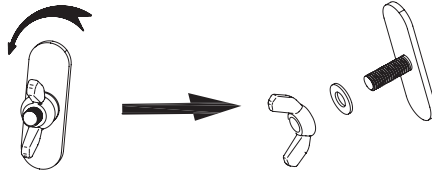

4. Thread the screw through the screw hole on the main adaptor panel, and screw on the butterfly nut, leaving a 2.5mm space.

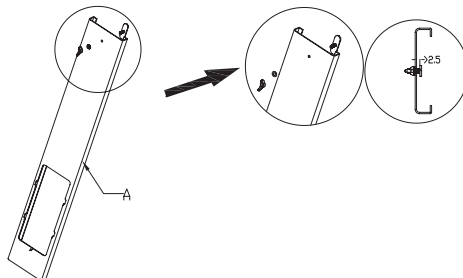

Installation Instructions

- Slide the extension panel between the main panel and the screw's 2.5mm gap and adjust the length needed to cover the window opening.

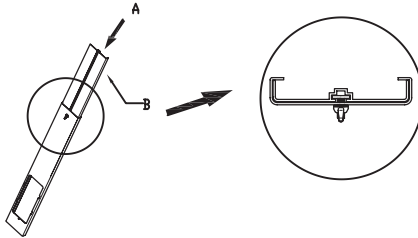

- Screw the butterfly nut tight to secure the adaptor kit.

E. Connect Exhaust Hose To Window Adaptor Kit

- Close the window till it fits snugly against the window adaptor kit.
- Lock the exhaust hose adaptor onto the opening in the window adaptor kit.

Note:

Place this product close to the window when connecting the exhaust hose. After exhaust hose is connected, move this product away from the window, and keep at least 20 inches (approx. 50cm) empty space between this product and any surrounding wall or object.

- DO NOT allow the exhaust hose to bend or flex more than 45° in order to keep good ventilation of exhaust hose.
- Make sure exhaust hose has been properly installed on both ends before using this product.
- When the Window Adaptor Kit is horizontally installed, make sure the "A" marked on the Exhaust Hose Adaptor faces upwards.

Operation Instructions

Control Panel

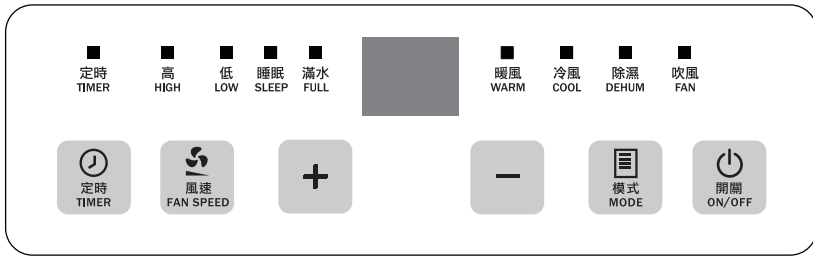

Icon	Description	Icon	Description	Icon	Description
	On/Off Button		Mode Button		Increase Button
	Timer Button		Fan Speed Button		Decrease Button
	Timer Indicator Light		High Fan Speed Indicator Light		Low Fan Speed Indicator Light
	Sleep Mode Indicator Light		Water Full Indicator Light		Warm Mode Indicator Light
	Cool Mode Indicator Light		Dehumidify Mode Indicator Light		Fan Mode Indicator Light

Turn On The Product





1. Connect product to the power source. Buzzer beeps once, control panel lights up for 1 second then turns dark, LED display shows current room temperature, and product enters standby state.
2. Press On/Off Button to turn on the product; by factory default, product runs in Cool Mode and High Fan Speed.
3. After using the product, press On/Off Button to turn off the product (product only returns to standby state, product will still be connected to power).

Note:

This product has built-in memory. When user presses On/Off Button to turn off the product, next time the product is turned on again, it will run in the previous setting. If the product is unplugged, the next time it is plugged in and turned on again, it will run in the factory default setting.



Operation Instructions

Mode Selection

1. When product is turned on, press Mode Button  to cycle among Cool Mode, Warm Mode, Dehumidify Mode and Fan Mode, the corresponding indicator light will light up constant.
2. After selecting your desired mode, press Increase Button  /Decrease Button  to adjust temperature, and press Fan Speed Button  to adjust fan speed (temperature only adjustable in Cool Mode or Warm Mode; fan speed non-adjustable in Dehumidify Mode).

Mode	Temperature	Fan Speed	LED Display
Cool Mode	Adjustable from 17°C-30°C	Adjustable (High/Low)	Shows set temperature
Warm Mode	Adjustable from 17°C-30°C	Adjustable (High/Low)	Shows set temperature
Dehumidify Mode	Not adjustable	Low Fan Speed by default, not adjustable	Shows current room temperature
Fan Mode	Not adjustable	Adjustable (High/Low)	Shows current room temperature

Sleep Mode



1. In Cool Mode or Warm Mode, press Timer Button  and Decrease Button  simultaneously to activate Sleep Mode.
2. In Sleep Mode, product runs in Low Fan Speed, fan speed is not adjustable; temperature is adjustable from 17°C-30°C; LED Display shows set temperature.

Note:

- Sleep Mode cannot be activated when product is running in Dehumidify Mode or Fan Mode.
- When product is running in Sleep Mode, pressing Mode Button will automatically exit Sleep Mode and return product to Dehumidify Mode or Fan Mode.

Off-Timer

To Set Off-Timer (time for product to automatically turn off):

1. Turn on the product, press Timer Button  to enter Timer Settings. Timer Indicator Light lights up constant.
2. Press Increase Button  /Decrease Button  to set off-timer from 1-24 hr. LED Display blinks timer duration.
3. If product does not receive any commands in 5 seconds, it will automatically confirm timer, and LED Display will switch back to show set temperature (if Cool Mode/Warm Mode has been selected) or show current room temperature (if Dehumidify Mode or Fan Mode has been selected).

On-Timer

To Set On-Timer (time for product to automatically turn on):

1. In standby state, press Timer Button  to enter Timer Settings. Timer Indicator Light lights up constant.

Operation Instructions

2. Press Increase Button **+** /Decrease Button **-** to set on-timer from 1-24 hr. LED Display blinks timer duration.
3. If product does not receive any commands in 5 seconds, it will automatically confirm timer, and LED Display will switch back to show current room temperature.
4. After countdown is completed, the product will automatically start to run in the setting before it was last turned off (memorized setting).

Cancel Timer

1. Press Timer Button **⌚** to enter Timer Settings, press Increase Button **+** /Decrease Button **-** until the timer reaches "0".
2. If product does not receive any further command in 5 seconds, it will automatically cancel the timer, and Timer Indicator Light will go dark.

Remote Control

Note:

- Before using the remote control, place in 2 AAA batteries. DO NOT use rechargeable batteries.
- When changing batteries, both batteries must be replaced together. DO NOT mix new and old batteries.
- If product will not be used for an extended period of time, remove batteries from the remote control and store batteries in a safe place.

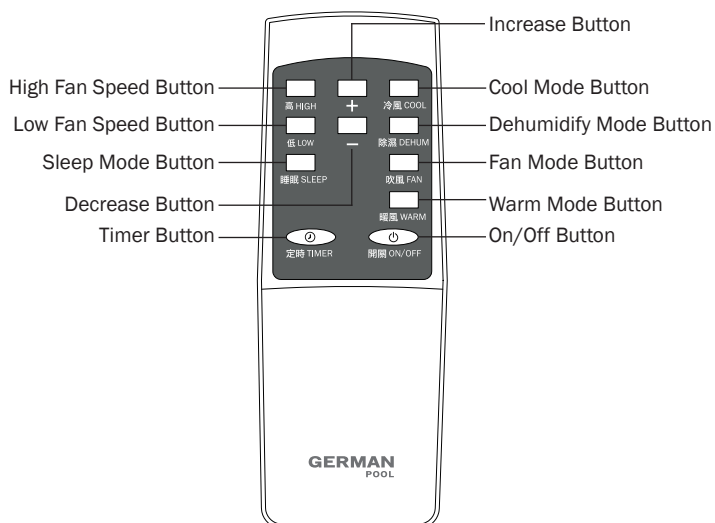

Operation Instructions

⚠ WARNING!

- If the remote control's battery fluid leaks onto skin or clothes, immediately rinse with large amount of water; DO NOT use remote control if battery is leaking.
- If battery fluid is swallowed, gargle and seek medical attention immediately. The chemicals in battery fluid can cause burning or other bodily harm.

Button	Description
On/Off	Press button to turn product on or off (return to standby state)
High Fan Speed	Press button to set fan speed to High (unavailable in Dehumidify Mode)
Low Fan Speed	Press button to set fan speed to Low (unavailable in Dehumidify Mode)
Timer	Press button to enter timer settings
Cool Mode	Press button to select Cool Mode
Dehumidify Mode	Press button to select Dehumidify Mode
Fan Mode	Press button to select Fan Mode
Warm Mode	Press button to select Warm Mode
Sleep Mode	Press button to select Sleep Mode (available only in Cool Mode or Warm Mode)
Increase/Decrease	Press button to adjust temperature (in Cool Mode or Warm Mode) or time (in Timer Settings)

Operation Instructions

Water Full Alert

When the water tank inside the main unit is full, buzzer will beep, Water Full Indicator Light on the Control Panel will light up constant. User must drain off the water inside the main unit before restarting the product.

Manual Drainage

1. Turn off the product and unplug product from the socket.
2. Place a tray or container (not included with product) under the Condensation Drain Port located at the bottom of the product's backside.
3. Unplug the Condensation Drain Port plug to let the water run out. User may tilt the product slightly to speed up drainage.
4. Re-plug the drain port after all the water has run out.

Note:

- Be careful not to let the water spill out when moving the product.
- If your container cannot hold all the water, please re-plug the drain port before the container is full, in order to avoid spillage wetting the floor or carpet.
- Make sure the plug has been re-plugged firmly before restarting the product so the new condensation will not spill out.

Continuous Drainage

1. Unplug the Continuous Drainage Outlet and connect a 13mm drain hose securely to the outlet.
2. Let the hose drain to the bathroom or outdoors.

Note:

- It is recommended NOT to use continuous drainage when product is operating in Cool Mode to ensure adequate water recycles in the unit to enhance the system's cooling effect.
- It is recommended to use continuous drainage when product is operating in Warm Mode and Dehumidify Mode to avoid frequent drainage.
- To avoid tripping over the drain hose, place it away from where people will be walking by. Also make sure the drain hose is not placed higher than the Continuous Drainage Outlet, and that the hose is not bent.

Compressor Delay Turn-On Protection

Aside from the first time the product is connected to the power source when the compressor may start to run immediately, each time the product is turned off and the compressor stops running, the product will activate a 3-minute delay turn-on safety mechanism whereby even if the product is turned on again immediately, the compressor will not restart until after 3 minutes.

Cleaning & Maintenance

WARNING!

Turn off the product and unplug from the power socket before cleaning and maintenance.

Surface Cleaning

- Unplug the product from the power source before cleaning.
- Wipe product surface with a soft moist cloth. **DO NOT** use alcohol, gasoline or other chemical solvents to avoid damaging this product. Using thinner, alcohol-glazer or other similar solvents to clean this product is strictly prohibited.
- Use moist soft cloth and neutral detergent to clean the air outlet and louvres. **DO NOT** use chemical solvents for cleaning, and **DO NOT** place such solvents near this product.

Filter Cleaning

- It is recommended to clean the filters once every two weeks, otherwise dust may clog the filters and affect the performance of this product.
- Grip the filters by their handles and gently pull them out. Immerse the filters in warm water (about 40°C) diluted with neutral detergent, rinse clean and allow them to air dry completely in the shade.

Note:

- Be careful when taking off the filters, take care not to twist or damage the filters.
- **DO NOT** squash or scratch the filters with sharp object or brush.
- **DO NOT** use this product without the filters installed.

Storage

Store this product away properly if it will not be used in an extended period of time.

1. Unplug the Condensation Drain Port on the back of the product and drain off the water completely (user can slightly tilt the product to speed up drainage).
2. Run the product in Fan Mode for **12** hours to let the interior of the product dry out completely in order to prevent the formation of mildew.
3. Turn off the product, unplug from the power socket, bundle up the power cord and plug the plug into the Power Plug Storage Slot at the back of the product, re-plug the Continuous Drainage Outlet and Condensation Drain Port.
4. Detach the exhaust hose, clean and let it air dry completely.
5. Remove the batteries from the remote control.

Note:

Store this product and all accessories in its original box, and place it in a dry and ventilated area out of children's reach.

Troubleshooting

Problem	Possible Cause	Solution
Product does not start	Power source failure	Connect the product to a live socket and restart product
	Water tank is full and Water Full Indicator Light is lit	Drain off water tank
	Ambient temperature too high or too low; room temperature is lower than the set temperature in Cool Mode, or room temperature is higher than the set temperature in Warm Mode	It is recommended to use this product in room temperature between 5-35 °C, or change the set temperature
Cooling or warming effect is not prominent	Product is placed in direct sunlight	Close the window curtains to avoid direct sunlight
	Window is open, room is crowded or there are other heat sources	Close door and window, and remove other heat sources
	Filters are dirty	Clean or replace filters
	Air inlet or outlet is blocked	Remove blockage
Product is very noisy	Product is placed on an uneven surface	Place product on an even and sturdy surface
Compressor does not run	Overheat protection activated	Wait 3 minutes until the product cools down and compressor will automatically restart
Remote control does not work	It is out of range	Bring remote control closer to the product, and aim it directly at the signal receptor
	Remote control is not aimed at the signal receptor on the unit	
	Battery is dead	Change the batteries
LED display shows "E1"	Room temperature sensor failure	Contact Customer Service & Repair Centre
LED display shows "E2"	Tube temperature sensor failure	
Water Full Indicator Light lights up constant	Water tank is full	Drain off the water then restart the product
Display shows temperature in °F (Fahrenheit) instead of °C (Celsius)	Accidentally tapped Increase Button and Decrease Button in Control Panel simultaneously	Simultaneously tap Increase Button and Decrease Button in Control Panel again to change °F back to °C

WARNING!

- DO NOT disassemble or repair this product on your own. Improper repair will cause the warranty to become voided, and may lead to personal injury and property damage.
- If problem persists or for problems not listed in the table above, please contact German Pool Customer Service & Repair Centre for assistance.

Technical Specification

Model	PAC-CH309	PAC-CH312
Voltage / Frequency	220-240V ~ 50 Hz	220-240V ~ 50 Hz
Power	960 W	1,250 W
Cooling Capacity (BTU)	9,000 BTU/hr	12,000 BTU/hr
Heating Capacity (BTU)	8,000 BTU/hr	11,000 BTU/hr
Maximum Allowable Pressure (Low Pressure)	2.0 MPa	2.0 MPa
Maximum Allowable Pressure (High Pressure)	2.6 MPa	5.0 MPa
Dehumidification Capacity (30 °C, RH80%)	1.25 L/hr	1.45 L/hr
Refrigerant / Charge	R290 / 140 g	R410a / 292 g
Product Dimensions	(H) 694 (W) 340 (D) 300 mm	
Net Weight	20.2 kg	22.3 kg

- Specification is subject to change without prior notice.
- If there is any inconsistency or ambiguity between the English version and the Chinese version, the English version shall prevail.
- Refer to www.germanpool.com for the most update version of the user manual.

目錄

警告及注意事項 19

產品結構 21

安裝說明 22

使用說明 25

清潔及保養 29

故障檢修 30

技術規格 30

保用條款 31

警告及注意事項

⚠ 警告！

使用本產品前，請仔細閱讀所有說明。

- 本產品只限家居室內日常使用，如產品作任何商業、工業、出租或其他用途，保用證即告失效。
 - 請勿讓兒童或身體有殘障、精神不健全及對本產品缺乏經驗或知識的人士單獨使用本產品；如需使用，必須要在負責任的成年人監管下方可使用。
 - 應照顧好兒童，確保他們不會玩弄本產品。
 - 無成年人監管下，勿讓兒童清潔及維護本產品。
 - 使用前，請先檢查所有電壓是否與本產品標籤上的電壓相符。
 - 如果電源線損壞，為免發生意外，電源線必須由廠方、廠方指定的維修中心或同等合格的技術人員進行更換。
 - 清潔或檢查本產品前，必須先關機及拔掉插頭。
 - 請聯繫德國寶授權的技術人員進行維修或保養本產品。
1. 除製造商推薦的方法外，嚴禁用任何其他方法加速除霜過程及進行清潔。
 2. 本產品必須存放在沒有持續點燃的火源（例如：明火、運行中的燃氣器具或運行中的電暖爐）的房間內。
 3. 嚴禁刺穿或燃燒本產品。
 4. 必須注意製冷劑可能沒有氣味。
 5. 必須保持所有必要的通風口暢通無阻。
 6. 本產品必須按照製造商的建議進行維修。
 7. 本產品必須放置在通風良好的地方，房間大小應與本產品適用的房間面積相符。
 8. 任何涉及製冷劑迴路工作的人員，都必須持有行業認可的評估機構頒發的有效證書，該證書授權他們有能力根據行業認可的評估規範安全處理製冷劑。
 9. 必須按照本產品製造商的建議進行維修。維護和修理必須在有能力使用易燃製冷劑的人員的監督下進行。
 10. 所有影響安全措施的工作程序必須由合資格人員進行。
 11. 移動時注意嚴禁碰撞本產品，以免製冷管路洩漏。
 12. 本產品只適合室內使用，嚴禁用於其他用途。
 13. 安裝本產品時必須遵守所在地區的規定，並確保正確接地。如您對電氣安裝有任何疑問，必須按照製造商的說明進行操作，且必須由專業電工進行安裝。
 14. 必須將本產品放置在平坦乾燥的地方，並使本產品與周圍物體或牆壁保持50cm以上的距離。
 15. 本產品安裝完畢後，必須確保電源插頭完好並牢固插入電源插座，電源線擺放整齊，防止絆倒或意外拔出插頭。
 16. 嚴禁將任何物品放入空調的進風口和出風口。保持進風口和出風口暢通無阻。
 17. 安裝排水管時，必須確保排水管連接正確，不得扭曲彎曲。
 18. 調整出風口上下導風板時，必須用手輕輕撥動，以免損壞導風條。
 19. 移動本產品時，必須確保本產品處於直立位置。
 20. 本產品必須遠離汽油、可燃氣體、火爐等熱源。

警告及注意事項

21. 嚴禁隨意拆卸、檢修和改裝本產品，否則會引起機器故障，甚至導至人身和財產危害。為避免發生危險，如本產品出現故障，必須由製造商或專業人員進行維修。
22. 嚴禁在浴室等潮濕環境中安裝和使用本產品。
23. 嚴禁以拔除插頭的方法關閉本產品。
24. 嚴禁在機身上放置杯子等物品，以免水或其他液體濺入本產品內。
25. 嚴禁在本產品附近使用殺蟲噴霧劑或其他易燃物質。
26. 嚴禁使用汽油、酒精等化學溶劑擦拭、清洗本產品。當您需要清潔本產品時，必須斷開電源，並用半濕的軟布清潔。如本產品太髒，建議用溫和的清潔劑擦洗。
27. 如8歲及以上的兒童以及身體、感官或精神上有缺陷的人在接受有關安全使用該設備的監督或指導並了解所涉及的危險的情況下，可以使用本產品。兒童嚴禁玩耍本產品。兒童嚴禁在沒有監督的情況下為本產品進行清潔和維護。
28. 如電源線損壞，必須由製造商、其服務代理或具有類似資格的人員更換，以免發生危險。
29. 本產品的安裝應符合所在地區的佈線規定。
30. ⚠ **警告！**本產品的遙控器包含電池。如果電池被吞下，可能在2小時內造成嚴重的內部燒傷，並可能導致死亡。新電池和舊電池應遠離兒童。如果電池蓋不能安全關閉，請停止使用遙控器，並將其遠離兒童。如果您認為電池可能被吞食或放置在身體任何部位，請立即就醫。電池含有對環境有害的材料；在報廢前，必須將其從設備中取出，並進行安全處理。
31. ⚠ **警告！**本產品必須在佔地面積大於7m²的房間內安裝、使用和存放（只適用於PAC-CH309）。



正確處置本產品

此標誌表明該產品不應與其他生活垃圾一起處理。為防止不受控制的廢物處理對環境或人類健康可能造成的危害，請負責任地回收本產品以促進材料資源的可持續再利用。要退回您用過的設備，請聯繫購買本產品的零售商，他們可將本產品用於對環境安全的回收。

產品結構

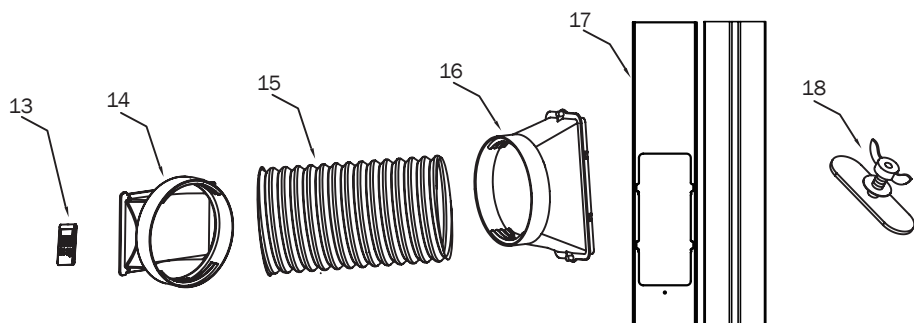
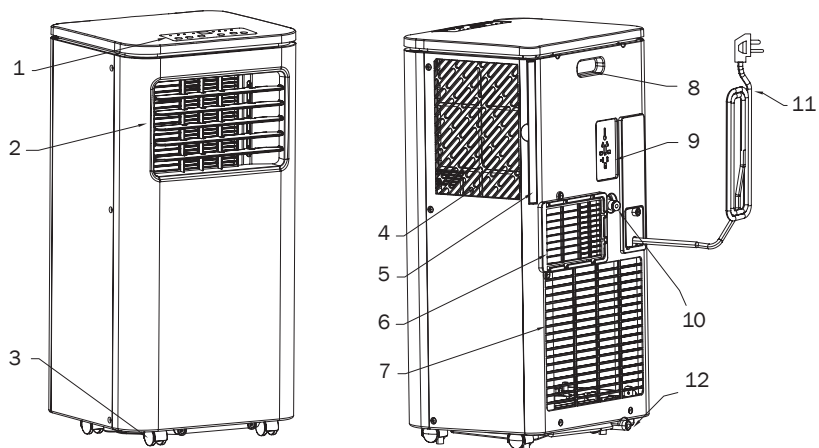

- | | |
|-------------|---------------|
| 1. 控制面板 | 11. 電源線 |
| 2. 出風口及導風板 | 12. 冷凝器排水口 |
| 3. 滾輪 | 13. 遙控器 |
| 4. 進風口 | 14. 排氣管接頭 |
| 5. 過濾網 | 15. 排氣管 |
| 6. 排氣管接頭固定槽 | 16. 排氣管外接頭 |
| 7. 進風口及過濾網 | 17. 窗戶密封板組件 |
| 8. 提手 | 18. 窗戶密封板組件螺絲 |
| 9. 電源插頭收納槽 | 19. 排水管 |
| 10. 連續排水孔 | |

安裝說明

⚠ 警告！

- 超重危險：建議由兩個或以上的人協助移動和安裝本產品。否則有機會導致背部或其他傷害。
- 搬運或移動本產品時必須握住機身的手柄，並確保本產品時刻處於直立位置。
- 嚴禁握住本產品出風口導風板進行移動。
- 在搬運或移動本產品前，必須將本產品中的水徹底排乾，以防止漏水弄濕地板或地毯。

安裝前注意事項

1. 本產品必須放置在堅固的平面上，以儘量減少噪音和振動。為了安全和牢固放置，請將本產品放置在足夠堅固的平穩水平地板上以支撐本機。
2. 本產品配備滾輪用以方便移動，但只能在平滑的平面上滾動。在地毯上滾動時要小心，在木地板上滾動時要小心並保護地板；嚴禁讓本產品滾過任何物體。
3. 本產品必須放置在能夠連接到適當的額定接地插座的地方。

⚠ 警告！

觸電危險：必須使用接地的三孔插座；嚴禁透過拉扯電源線從插座上拔下插頭；嚴禁使用萬能蘇；嚴禁使用拖板；否則可能導致死亡、火災或觸電。

4. 嚴禁在本產品的進風口和出風口周圍放置任何物品。
5. 排氣管可以拉長，但長度建議保持在所需的最短長度。必須確保排氣管沒有任何急轉彎或凹陷。
6. 跟機附送的窗戶密封板組件適用於大多數標準垂直滑動或水平滑動的窗戶，但是，對於其他窗戶類型，可能需要修改安裝程序。

A. 拆除包裝材料

1. 首次使用前必須先拆除包裝材料。
2. 建議保留紙箱和發泡膠包裝，以便在不使用時存放本產品。

注意：

- 本產品主機內沒有包裝材料可以拆除，嚴禁拆開機身。
- 妥善處理及回收所有包裝材料。
- 必須輕拿輕放，並保持本產品直立和水平。嚴禁將本產品側放或倒置。

安裝說明

B. 組裝排氣管

1. 握住排氣管的兩端，輕輕拉長排氣管。
2. 將排氣管開口端對準排氣管接頭，逆時針旋轉至扣緊。
3. 將排氣管另一開口端對準排氣管外接頭，逆時針旋轉至扣緊。

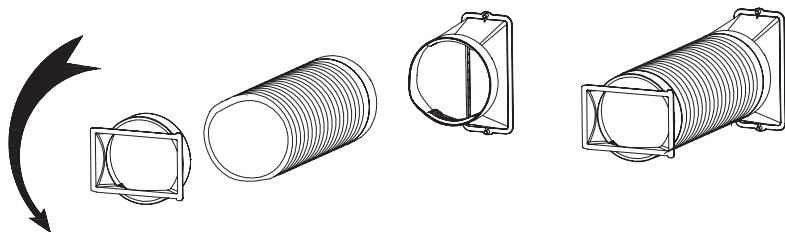

注意：

嚴禁連接額外的軟管來延長排氣管長度，避免降低本產品製冷效率，並有可能損壞本產品。

C. 連接排氣管至機身

1. 將排氣管接頭對準機身背面的排氣管接頭固定槽。
2. 將排氣管接頭從左向右滑動至扣緊，即成。

D. 安裝窗戶密封板組件

注意：

- 窗戶密封板組件適用於垂直滑動或水平滑動的窗戶。
- 如窗戶開口小於窗戶密封板元件的最小長度，請切掉窗戶密封板組件無孔側的末端，使其足夠短以適合窗戶開口。嚴禁切掉窗戶密封板組件中的孔。

1. 按窗戶開口的大小，使用主面板及擴展面板。
2. 打開窗戶，將主面板放入窗戶開口中。

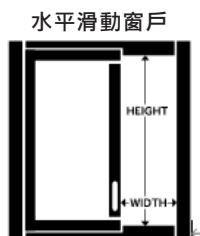
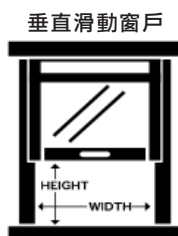

安裝說明

3. 使用跟機附送的螺絲，按下圖方法拆開螺絲。

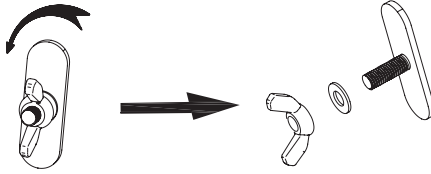

4. 將螺絲扣在主面板上，擰緊螺絲並預留約2.5mm間距的空隙。

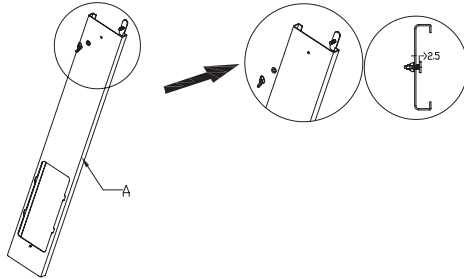

5. 將擴展面板卡入主面板與螺絲之間的空隙，將面板調整成窗口的寬度或高度。

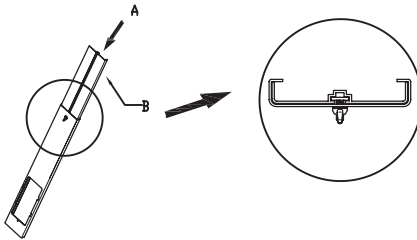

6. 擰緊螺絲以固定窗戶密封板組件。

E. 連接排氣管至窗戶

1. 將窗戶關閉到與窗戶密封板組件緊貼，完全覆蓋窗戶開口。
2. 將排氣管外接頭對準窗戶密封板組件上的卡槽，扣緊完成安裝。

注意：

- 連接排氣管時，本產品必須離窗戶足夠近；連接完成後，將本產品移離牆壁20英寸（約50厘米），並與周圍的物件保持至少20英寸（約50厘米）距離。
- 嚴禁將排氣管彎曲至超過45°，以保持排氣管良好通風。
- 使用前必須確保排氣管已安裝在正確位置及安裝穩妥。
- 當窗戶密封板組件水平安裝時，確保排氣管外接頭上帶「A」標記的一面朝上。

使用說明

控制面板

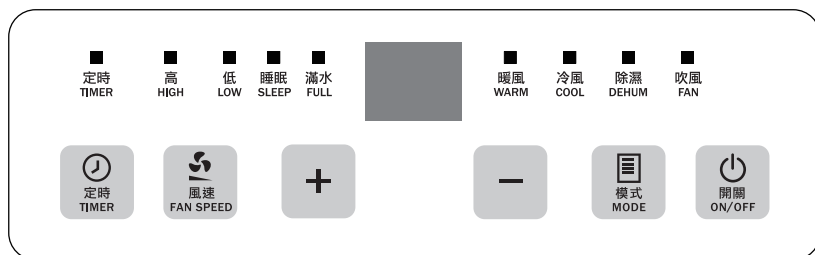

圖標	說明	圖標	說明	圖標	說明
	開關鍵		模式鍵		加鍵
	定時鍵		風速鍵		減鍵
	定時指示燈		高風速指示燈		低風速指示燈
	睡眠模式指示燈		滿水指示燈		暖風模式指示燈
	冷風模式指示燈		除濕模式指示燈		吹風模式指示燈

接通電源

1. 連接電源後，蜂鳴器發出提示聲一聲；控制面板全亮1秒後熄滅，顯示屏顯示當前室溫，進入待機模式。
2. 按「開關鍵 」開機，首次開機預設以冷風模式及高風速運行。
3. 使用完畢後，按「開關鍵 」關機（返回待機狀態，不會斷開本產品與電源的連接）。

注意：

本產品設有記憶功能，按「開關鍵 」關機後再重新開機，將以上一次關機前的設置繼續運行；直至斷開電源（拔除電源插頭）後再重新開機，以首次開機的預設模式運行。

選擇模式

1. 開機後按「模式鍵 」循環選擇冷風模式、暖風模式、除濕模式及吹風模式，相應指示燈常亮。
2. 選擇對應模式後，可按「加鍵 /減鍵 」調整溫度；按「風速鍵 」調整風速（溫度調整只適用於冷風模式及暖風模式；風速調整不適用於除濕模式）。

使用說明

模式	溫度	風速	顯示屏
冷風模式	可調17°C-30°C	可調高風速或低風速	顯示設定溫度
暖風模式	可調17°C-30°C	可調高風速或低風速	顯示設定溫度
除濕模式	不可調	預設低風速，不可調	顯示當前室溫
吹風模式	不可調	可調高風速或低風速	顯示當前室溫



睡眠模式

1. 在冷風模式或暖風模式下，同時按「定時鍵 」及「減鍵 」進入睡眠模式。
2. 在睡眠模式下，預設以低風速運行，風速不可調；溫度可調17°C-30°C，顯示屏顯示設定溫度。



注意：

- 在除濕模式及吹風模式下，無法使用睡眠模式。
- 如在睡眠模式下，按「模式鍵 」切換至除濕模式或吹風模式，將自動退出睡眠模式。



定時開機

1. 開機後按「定時鍵 」進入定時設置，定時指示燈常亮。
2. 按「加鍵  / 減鍵 」調整1-24小時定時，顯示屏閃爍顯示所選擇的時間。
3. 如5秒內無任何操作，將自動確認所選時間，顯示屏轉回顯示設定溫度（冷風模式或暖風模式）或當前室溫（除濕模式或吹風模式）。

定時開機

1. 在產品待機狀態下按「定時鍵 」進入定時設置，定時指示燈常亮。
2. 按「加鍵  / 減鍵 」調整1-24小時定時，顯示屏閃爍顯示所選擇的時間。
3. 如5秒內無任何操作，將自動確認所選時間，顯示屏轉回顯示當前室溫。
4. 倒數完成後，自動以上一次關機前的設置運行。

取消定時

1. 按「定時鍵 」進入定時設置，按「加鍵  / 減鍵 」將時間調整為0。
2. 如5秒內無任何操作，將自動確認取消定時，定時指示燈熄滅。

使用說明

遙控器

注意：

- 使用前請先插入兩節AAA電池；嚴禁使用充電電池。
- 更換電池時，必須同時更換2節電池，嚴禁混用新舊電池。
- 如長時間不使用本產品，必須取出遙控器的電池並妥善存放。

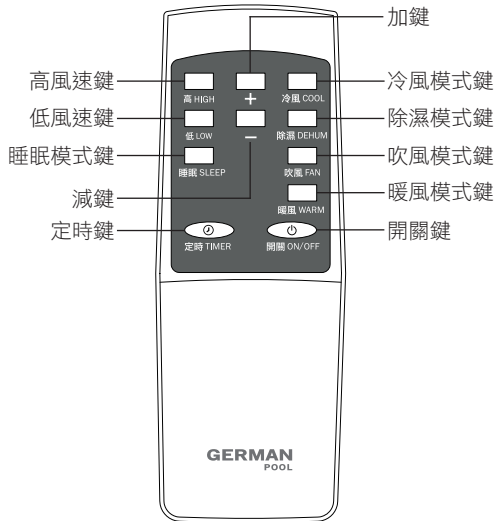

⚠ 警告！

- 如遙控器電池液漏到皮膚或衣服上，必須盡快用大量清水沖洗；發現洩漏，嚴禁使用遙控器。
- 如吞下電池液，必須盡快漱口並就醫。電池中的化學物質可能會燃燒或造成其他健康危害。

按鍵	說明
開關鍵	接通電源後按鍵開機或關機（返回待機狀態）
高風速鍵	按鍵設定風速為高風速（不適用於除濕模式）
低風速鍵	按鍵設定風速為低風速（不適用於除濕模式）
定時鍵	按鍵進入定時設置
冷風模式鍵	按鍵選擇冷風模式
除濕模式鍵	按鍵選擇除濕模式
吹風模式鍵	按鍵選擇吹風模式
暖風模式鍵	按鍵選擇暖風模式
睡眠模式鍵	按鍵進入睡眠模式（只適用於冷風模式及暖風模式）
加鍵/減鍵	按鍵調整溫度（冷風模式及暖風模式下）或調整時間（定時設置下）

使用說明

滴水提示

當機內水滿，產品將發出蜂鳴器提示聲，控制面板上的滴水指示燈常亮，需要排掉冷凝水並重新啟動本產品。

手動排水

1. 將本產品關機並拔除電源插頭。
2. 將托盤或容器（自備）放在機身背面冷凝器排水口下。
3. 打開冷凝器排水口的膠塞，將冷凝水完全排出，可輕輕傾斜本產品以加速排水。
4. 將冷凝水排清後，塞上膠塞。

注意：

- 移動本產品時必須小心以免漏水。
- 如果容器無法容納所有的水，請在裝滿前盡快堵住冷凝器排水口，以防止漏水弄濕地板或地毯。
- 膠塞必須安裝牢固，以免產品重新開始工作時，新的冷凝水弄濕地板或地毯。

連續排水

1. 打開連續排水孔的膠塞，用 $\phi 13\text{mm}$ 的排水管連接排水孔
2. 將排水管拉到浴室或室外進行排水。

注意：

- 建議避免在冷風模式時使用連續排水，以確保機內有足夠的水循環以增強系統冷卻效果。
- 建議在暖風模式及除濕模式下使用連續排水，避免頻繁手動排水。
- 將排水管放在不易接近的地方，避免高於排水孔，並保持排水管筆直，無任何彎曲。

壓縮機延時保護功能

除第一次接通電源後，壓縮機可能立即啟動外，每次關機壓縮機停止運行後，產品進入3分鐘延時再啟動保護，3分鐘內無法再啟動壓縮機。

清潔及保養

⚠ 警告！

在維修或保養前，必須先關機並拔除電源插頭。

清潔產品表面

- 清潔前必須拔除電源插頭。
- 用濕軟布清潔本產品表面，嚴禁使用酒精和汽油等化學溶劑，以免損壞本產品。清潔本產品時嚴禁使用任何稀釋劑、酒精或其他類似溶劑。
- 用濕軟布和中性清潔劑清潔出風口。嚴禁使用任何化學溶劑清洗機身組件或在本產品附近長期放置此類物品。

清潔過濾網

- 建議每兩星期清潔一次過濾網，否則過濾網被灰塵堵塞會影響本產品性能。
- 握住過濾網提手輕輕拉出，將過濾網浸入混有中性清潔劑的溫水（約40°C）中輕輕清洗，然後置於陰涼處晾乾。

注意：

- 拉出過濾網時必須小心，避免扭曲或損壞過濾網。
- 嚴禁用尖銳的物體或刷子擠壓或撞擊過濾網。
- 嚴禁在未安裝過濾網的情況下使用本產品。

收納本產品

不使用本產品時，請妥善存放。

1. 打開機身背面冷凝器排水口的膠塞，將冷凝水完全排出，可輕輕傾斜本產品以加速排水。
2. 使用本產品的「吹風模式」運行約12小時，使機內部件完全乾燥，防止發霉。
3. 關閉本產品並拔除插頭，將電源線收好並將插頭插入機身背面的電源插頭收納槽，裝好冷凝器排水口及連續排水孔的膠塞。
4. 拆下排氣管清洗乾淨後置於陰涼處風乾。
5. 從遙控器中取出電池並妥善保管。

注意：

確保本產品存放在乾燥的地方。所有配件必須一起妥善保護，並使本產品遠離兒童。

故障檢修

故障情況	可能原因	解決方法
產品無法開機	電源故障	將設備連接到帶電的插座並開機
	儲水箱滿水及滿水指示燈常亮	排乾本產品的積水
	環境溫度太高或太低；在冷風模式下室溫低於設定溫度，或暖風模式下室溫高於設定溫度	建議在室溫5-35°C之間使用本產品，更改設定溫度
製冷或製暖效果差	有陽光直射本產品	拉上窗簾避免陽光照射
	門窗打開，房間擁擠或有其他熱源	關閉門窗並移除其他熱源
	過濾網髒污	清潔或更換過濾網
	進風口或出風口堵塞	清除堵塞物
產品發出異常噪音	產品放置在不平坦的表面上	將本產品放置在平坦牢固的地方
壓縮機不運作	過熱保護啟動	等待約3分鐘直至溫度下降，壓縮機將自動重新啟動
遙控器無法使用	距離太遠	將遙控器靠近本產品，確保對準信號接收器
	遙控器沒對準主機上的信號接收器	信號接收器
	電池沒電	更換電池
顯示屏顯示「E1」	室溫傳感器故障	聯絡德國寶客戶服務及維修中心
顯示屏顯示「E2」	管溫傳感器故障	
滿水指示燈常亮	儲水箱滿水	排乾本產品的積水後重新開機
顯示屏溫度顯示為華氏°F而非攝氏°C	錯誤地同時按下控制面板上的加鍵及減鍵	同時按控制面板上的加鍵及減鍵將°F轉回°C

⚠ 警告！

- 嚴禁擅自拆卸或維修本產品，維修不當將使保養失效，並可能對您和您的財產造成傷害。
- 如果產品的問題未在上表中列出，請聯絡德國寶客戶服務及維修中心。

技術規格

型號	PAC-CH309	PAC-CH312
電壓/頻率	220-240V ~ 50 Hz	220-240V ~ 50 Hz
功率	960 W	1,250 W
製冷能力 (BTU)	9,000 BTU/hr	12,000 BTU/hr
製暖能力 (BTU)	8,000 BTU/hr	11,000 BTU/hr
最高可使用壓力 (低壓)	2.0 MPa	2.0 MPa
最高可使用壓力 (高壓)	2.6 MPa	5.0 MPa
除濕量 (30°C, RH80%)	1.25 L/hr	1.45 L/hr
製冷劑	R290 / 140 g	R410a / 292 g
產品尺寸	(H) 694 (W) 340 (D) 300 mm	
淨重	20.2 kg	22.3 kg

- 產品規格及設計如有變更，恕不另行通知。
- 中英文版本如有出入，一概以英文版為準。
- 本產品使用說明書以www.germanpool.com網上版為最新版本。

保用條款

此保用提供德國寶產品之機件在正常使用下壹年保用(自購買日起計算)。

Warranty Terms & Conditions

Under normal operations, the product will guarantee a 1-year warranty provided by German Pool (effective from the date of purchase).

* 貴戶須在購機十天內，以下列其中一種方式向本公司登記資料，保用手續方正式生效：

- 1) 填妥德國寶VIP手機應用程式保用登記表(掃描右方二維碼)
- 2) 填妥本公司網頁保用登記表
www.germanpool.com/warranty
- 3) 填妥保用卡郵寄至本公司。



* This warranty is not valid until customer registration information is received by our Service Centre within 10 days of purchase via one of the following means:

- 1) Visit our VIP App and register online:
(Scan the QR Code on the right)
- 2) Visit our website and register online:
www.germanpool.com/warranty
- 3) Complete the attached Warranty Card and mail it back to our Customer Service Centre.



另請填妥以下表格並與正本發票一併保存，以便維修時核對資料。用戶提供之所有資料必須正確無誤，否則免費保用將會無效。 Please fill out the form below. This information and the original purchase invoice will be required for any repairs. Warranty will be invalidated if information provided is found to be inaccurate.

型號 Model No. : PAC-CH309 PAC-CH312

機身號碼 Serial No. : _____ 發票號碼 Invoice No. : _____

購買商號 Purchased From : _____ 購買日期 Purchase Date : _____

1. 未能出示購買發票正本者，將不獲免費維修服務。
2. 用戶應依照說明書的指示操作。本保用並不包括：
 - 上門安裝、檢驗、維修或更換零件之人工以及一切運輸費用；
 - 因天然與人為意外造成的損壞(包括運輸及其他)；
 - 電源接合不當、不依說明書而錯誤或疏忽使用本機所引致之損壞。
3. 於下列情況下，用戶之保用資格將被取消：
 - 購買發票有任何非認可之刪改；
 - 產品被用作商業或工業用途；
 - 產品經非認可之技術人員改裝或加裝任何配件；
 - 機身編號被擅自塗改、破壞或刪除。
4. 總代理有權選擇維修或更換配件或其損壞部份。
5. 產品一經被轉讓，其保用即被視作無效。

1. Customer who fails to present original purchase invoice will not be eligible for free warranty service.
2. Customer should always follow the operating instructions. This warranty does not apply to:
 - labour costs for on-site installation, check-up, repair, replacement of parts and other transportation costs;
 - damages caused by accidents of any kind (including material transfer and others);
 - operating failures resulting from applying incorrect voltage, improper usage, and unauthorized installations or repairs.
3. This warranty is invalid if:
 - the purchase invoice is modified by an unauthorized party;
 - the product is used for any commercial or industrial purposes;
 - the product is repaired or modified by unauthorized personnel, or unauthorized parts are installed;
 - the serial number is modified, damaged or removed from the product.
4. German Pool will, at its discretion, repair or replace any defective part.
5. This warranty will be void if there is any transfer of ownership from the original purchaser.

客戶服務及維修中心

中國香港

九龍大業街59號

三湘九龍灣貨運中心地下B室

電話：+852 2333 6249

傳真：+852 2356 9798

電郵：repairs@germanpool.com

中國澳門

澳門青洲大馬路(青洲新路)

515號美居廣場第二期1樓A座

電話：+853 2875 2699

傳真：+853 2875 2661

Customer Service & Repair Centre

Hong Kong, China

Unit B, G/F, Sunshine Kowloon Bay

Cargo Centre, 59 Tai Yip Street,

Kowloon, Hong Kong

Tel : +852 2333 6249

Fax : +852 2356 9798

Email : repairs@germanpool.com

Macau, China

A, 1. Andar, Mei Kui Kuong Cheong Fase 2,

No.515 Avenida Do Conselheiro Borja

Macau

Tel : +853 2875 2699

Fax : +853 2875 2661

此保用只適用於香港及澳門

This warranty is valid only in Hong Kong and Macau

German Pool (Hong Kong) Limited

Hong Kong, China

Room 113, Newport Centre Phase II, 116 Ma Tau
Kok Road, Tokwanan, Kowloon, Hong Kong.
Tel: +852 2773 2888
Fax: +852 2765 8215

Mainland China

8th, Xinxiang Road, Wusha Industrial Park,
Daliang, Shunde, Foshan, Guangdong
Tel: +86 757 2219 6888
Fax: +86 757 2219 6809

Macau, China

A, 1 Andar, Mei Kui Kuong Cheong Fase 2,
No.515 Avenida Do Conselheiro Borja, Macau
Tel: +853 2875 2699
Fax: +853 2875 2661



香港《S MARK》
安全認證



中國櫥櫃/家電行業
十大影響力品牌



CEO非凡品牌大賞



香港優質商標



香港工商業獎



2007
最具潛質
創星品牌企業獎



香港中小企業
最佳拍攝大獎



香港消費者推祟品牌



香港《心博》
優質服務證書



香港名牌十年成就獎
HONG KONG TOP BRAND TEN YEAR
ACHIEVEMENT AWARD

© All rights reserved. Copying, reproducing or using the contents of this manual is not allowed without prior authorization from German Pool, violators will be prosecuted.