

WiFi Smart Portable Air Conditioner

PAC-CH416-SC



Online Warranty Registration



Please read these instructions and warranty information carefully before use and keep them handy for future reference.

## USER MANUAL

請即進行保用登記！  
有關保用條款細則，請看說明書最後一頁。

---

Please register your warranty information now !  
For Warranty Terms & Conditions,  
please refer to the last page of this user manual.

# Table of Contents

---

Warnings & Safety Precautions 04

Product Structure 08

Installation Instructions 09

Operation Instructions 14

Cleaning & Maintenance 29

Troubleshooting 30

Technical Specification 31

Warranty Terms & Conditions 59

# Warnings & Safety Precautions

## **WARNING!**

Read all instructions carefully before using this product.

- This product is for domestic indoor use only. If this product is used for any commercial, industrial, rental or other purposes, product warranty will be VOIDED.
- This product is not intended for use by children or persons with reduced physical, sensory or mental capabilities, or lack of experience and knowledge, unless they have been given supervision or instruction concerning use of this product by an adult responsible for their safety.
- Mind your children and DO NOT let children play with this product.
- Cleaning and user maintenance shall not be made by children without supervision.
- Check the voltage indicated on the rating label before using this product.
- If the supply cord is damaged, it must be replaced by the manufacturer, its service agent or similarly qualified persons in order to avoid hazards.
- Unplug this product from the power source before cleaning and maintenance.
- Contact German Pool authorized service technician for repair or maintenance of this product.

## **WARNING!**

This product uses a flammable refrigerant. If refrigerant leaks and comes in contact with fire or heating part, it will create harmful gas and there is risk of fire.



Caution, risk of fire  
R290



Appliance is filled with flammable gas R290.



Before using the appliance, read the manual.



Before installing the appliance, read the installation manual.



Any repairs you need, contact German Pool Customer Service and Repair Centre and strictly follow manufacturer's instruction only.

### The following should always be observed for safety:

1. This product can be used by children aged from 8 years and above and persons with reduced physical, sensory or mental capabilities or lack of experience and knowledge if they have been given supervision or instruction concerning use of this product in a safe way and understand the hazards involved. Children shall not play with this product. Cleaning and user maintenance shall not be made by children without supervision.
2. This product is designed only for use with R-290 (propane) gas as the designated refrigerant.
3. The refrigerant loop is sealed. Only a qualified technician should attempt to service!
4. Do not discharge the refrigerant into the atmosphere.
5. R-290 (propane) is flammable and heavier than air.
6. R-290 collects first in low areas but can be circulated by the fans.

# Warnings & Safety Precautions

---

7. If propane gas is present or even suspected, do not allow untrained personnel to attempt to find the cause.
8. The propane gas used in this product has no odor. The lack of smell does not indicate a lack of escaped gas.
9. If a leak is detected, immediately evacuate all persons from the room, ventilate the room and contact the local fire department to advise them that a propane leak has occurred.
10. Do not let any persons back into the room until the qualified service technician has arrived and that technician advises that it is safe to return to the room.
11. No open flames, cigarettes or other possible sources of ignition should be used inside or in the vicinity of this product.
12. Component parts are designed for propane and non-incentive and non-sparking. Component parts shall only be replaced with identical repair parts.
13. This product's remote control contains batteries. If the battery is swallowed, it can cause severe internal burns in just 2 hours and can lead to death. Keep new and used batteries away from children. If the battery compartment does not close securely, stop using the remote control and keep it away from children. If you think batteries might have been swallowed or placed inside any part of the body, seek immediate medical attention. The batteries contain materials which are hazardous to the environment; they must be removed from the remote control before it is scrapped and that they are disposed of safely
14. Failure to abide by the above warnings could result in an explosion, death, injury and property damage.

## **To reduce the risk of fire, electric shock or injury to persons or property:**

1. If the supply cord is damaged, it must be replaced by the manufacturer, its service agent or similarly qualified persons in order to avoid a hazard.
2. This product must be disconnected from its power source during service.
3. Always operate the unit from a power source of equal voltage, frequency and rating as indicated on the product identification plate.
4. Always use a power outlet that is grounded.
5. Unplug the power cord when cleaning or when this product is not in use.
6. DO NOT operate this product with wet hands. Prevent water from spilling onto this product.
7. DO NOT immerse or expose this product to rain, moisture or any other liquid.
8. DO NOT leave this product running unattended. DO NOT tilt or turn over this product.
9. DO NOT unplug while this product is operating.
10. DO NOT unplug this product by pulling on its power cord.
11. DO NOT use an extension cord or an adaptor plug.
12. DO NOT put objects on this product.
13. DO NOT climb or sit on this product.
14. DO NOT insert fingers or other objects into the air outlet.
15. DO NOT touch the air inlet or the aluminum fins of this product.
16. DO NOT operate this product if it is dropped, damaged or showing signs of product malfunction.
17. DO NOT clean this product with any chemicals.
18. Ensure this product is far away from fire, inflammable, or explosive substances.
19. This product shall be installed in accordance with your local wiring regulations.
20. DO NOT use means to accelerate the defrosting process or to clean, other than those recommended by the manufacturer.

# Warnings & Safety Precautions

---

21. This product shall be stored in a room without continuously operation sources (for example: open flames, an operating gas appliance or an operating electric heater).
22. This product shall be stored so as to prevent mechanical damage from occurring.
23. DO NOT pierce or burn this product, even after use or when it is discarded.
24. Be aware that refrigerants may not contain an odour.
25. Pipe-work shall be protected from physical damage and shall not be installed in an unventilated space, if that space is smaller than 13 m<sup>2</sup>.
26. Compliance with your local gas regulations shall be observed.
27. Keep any required ventilation openings clear of obstruction.
28. This product shall be stored in a well-ventilated area where the room size corresponds to the room area as specified for operation.

## **WARNING!**

- Any person who is involved with working on or breaking into a refrigerant circuit should hold a current valid certificate from an industry-accredited assessment authority, which authorizes their competence to handle refrigerants safely in accordance with an industry-recognized assessment specification.
- Servicing shall only be performed as recommended by the equipment manufacturer. Maintenance and repair requiring the assistance of other skilled personnel shall be carried out under the supervision of the person competent in the use of flammable refrigerants.

## **When servicing products with R290, the following warnings must be observed:**

1. Checks To The Area  
Prior to beginning work on systems containing flammable refrigerants, safety checks are necessary to ensure that the risk of ignition is minimized. For repair to the refrigerating system, the following precautions shall be complied with prior to conducting work on the system.
2. Work Procedure  
Work shall be undertaken under a controlled procedure so as to minimize the risk of a flammable gas or vapor being present while the work is being performed.
3. General Work Area  
All maintenance staff and others working in the local area shall be instructed on the nature of work being carried out. Work in confined spaces shall be avoided. The area around the work space shall be sectioned off. Ensure that the conditions within the area have been made safe by control of flammable material.
4. Checking For Presence Of Refrigerant  
The area shall be checked with an appropriate refrigerant detector prior to and during work, to ensure the technician is aware of potentially flammable atmospheres. Ensure that the leak detection equipment being used is suitable for use with flammable refrigerants, i.e. no sparking, adequately sealed or intrinsically safe.
5. Presence Of Fire Extinguisher  
If any hot work is to be conducted on the refrigeration equipment or any associated parts, appropriate fire extinguishing equipment shall be available to hand. Have a dry powder or CO2 fire extinguisher adjacent to the charging area.
6. No Ignition Sources  
No person carrying out work in relation to a refrigeration system which involves exposing any pipe work that contains or has contained flammable refrigerant shall use any sources of ignition in such a manner that it may lead to the risk of fire or explosion. All possible ignition sources,

# Warnings & Safety Precautions

---

including cigarette smoking, should be kept sufficiently far away from the site of installation, repairing, removing and disposal, during which flammable refrigerant can possibly be released to the surrounding space. Prior to work taking place, the area around the equipment is to be surveyed to make sure that there are no flammable hazards or ignition risks. “No Smoking” signs shall be displayed.

## 7. Ventilated Area

Ensure that the area is in the open or that it is adequately ventilated before breaking into the system or conducting any hot work. A degree of ventilation shall continue during the period that the work is carried out. The ventilation should safely disperse any released refrigerant and preferably expel it externally into the atmosphere.

## 8. Checks To The Refrigeration Equipment

Where electrical components are being changed, they shall be fit for the purpose and to the correct specification. At all times the manufacturer’s maintenance and service guidelines shall be followed. If in doubt consult the manufacturer’s technical department for assistance.

The following checks shall be applied to installations using flammable refrigerants:

- The charge size is in accordance with the room size within which the refrigerant containing parts are installed;
- The ventilation machinery and outlets are operating adequately and are not obstructed;
- If an indirect refrigerating circuit is being used, the secondary circuit shall be checked for the presence of refrigerant;
- Marking to the equipment continues to be visible and legible. Markings and signs that are illegible shall be corrected;
- Refrigeration pipe or components are installed in a position where they are unlikely to be exposed to any substance which may corrode refrigerant-containing components, unless the components are constructed of materials which are inherently resistant to being corroded or are suitably protected against being so corroded.

## 9. Checks To Electrical Devices

Repair and maintenance to electrical components shall include initial safety checks and component inspection procedures. If a fault exists that could compromise safety, then no electrical supply shall be connected to the circuit until it is satisfactorily dealt with. If the fault cannot be corrected immediately but it is necessary to continue operation, an adequate temporary solution shall be used. This shall be reported to the owner of the equipment so all parties are advised.

Initial safety checks shall include:

- those capacitors are discharged: this shall be done in a safe manner to avoid possibility of sparking;
- that no live electrical components and wiring are exposed while charging, recovering or purging the system;
- that there is continuity of earth bonding.



### Correct Disposal of this product

This marking indicates that the product should not be disposed with other household wastes. To prevent possible harm to the environment or human health from uncontrolled waste disposal, recycle it responsibly to promote the sustainable reuse of material resources. To return your used device, please use the return and collection systems or contact the retailer where the product was purchased. They can take this product for environmentally safe recycling.

# Product Structure

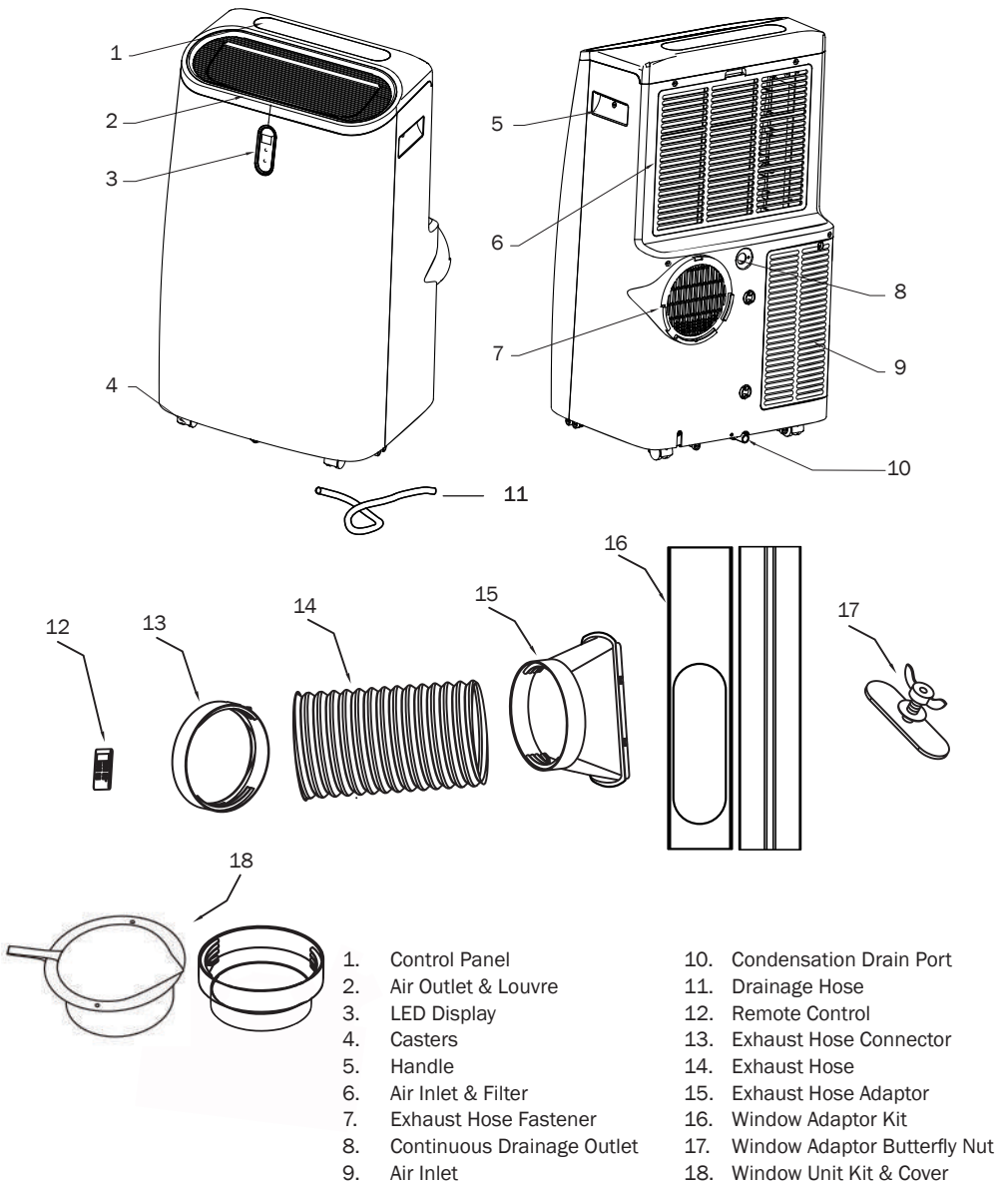



# Installation Instructions

---

## **WARNING!**

- DO NOT install this product in a room smaller than 13m<sup>2</sup>.
- DO NOT install this product in a place where inflammable gas may leak.
- Excessive Weight Hazard: It is recommended to have 2 or more persons to move and install this product. Failure to do so can result in back or other injury.
- During handling and transportation, always hold the product by the handle, and maintain the unit in its upright position at all times.
- DO NOT move the product by gripping its louvre.
- Before moving or transporting this product, drain off the water in the unit completely to prevent water leakage wetting the floor or carpet

## **Before Installation**

1. This product must be placed on a firm foundation to minimize noise and vibration. For safe and secure positioning, place this product on a smooth and level floor strong enough to support this product.
2. This product has casters to aid moving it around, but it must only be rolled on smooth flat surfaces. Use caution when rolling on carpeted surfaces and hardwood floors. DO NOT roll this product over objects.
3. This product must be placed within reach of a properly rated grounded socket.

## **WARNING!**

Electric Shock Hazard: This product must be plugged into a grounded 3-pin outlet; DO NOT pull on the cord to unplug the plug; DO NOT use an adaptor; DO NOT use with extension cord; failure to comply can result in death, fire or electric shock.

4. DO NOT place any objects around this product's air inlets and air outlets. DO NOT place this product near walls, curtains or other objects that may block the air outlets; keep air inlets and outlets clear of obstacles at all times. It is recommended to leave at least 50cm empty space on all sides of this product to ensure adequate ventilation.
5. The exhaust hose can be extended, but it is optimized when the hose is at its shortest necessary length. Also make sure the hose does not have any sharp bends or sags.
6. The window adaptor kit is designed to fit most standard vertical and horizontal sliding window applications. However, it may be necessary to modify some aspects of the installation procedures for certain types of windows.
7. If this product has been tipped more than 45° during transportation, let this product stand upright at least 24 hours before turning it on.
8. DO NOT install this product where it could be subject to:
  - Heat sources such as radiators, heat registers, stoves or other products that produce heat
  - Direct sunlight
  - Mechanical vibration or shock
  - Excessive dust
  - Lack of ventilation, such as cabinet or bookcase
  - Uneven surface

# Installation Instructions

---

## A. Remove Packing Materials

1. Remove all packing materials before using product for the first time.
2. It is recommended to save the carton box and styrofoam packing for storing the product when not in use.

### Note:

- There are NO packing materials inside the product to remove. DO NOT disassemble the product body.
- Properly dispose/recycle all packing materials.
- Handle the product gently, and keep it upright and level at all times. DO NOT set this product on its side, front, back or upside down.

## B. Install Exhaust Hose

1. Grasp both ends of the exhaust hose and gently pull to expand the hose.
2. Screw one end of the hose to the exhaust hose connector using a clockwise motion, until it is firmly attached.
3. Screw the other end of the hose to the exhaust hose adaptor using a clockwise motion, until it is firmly attached.

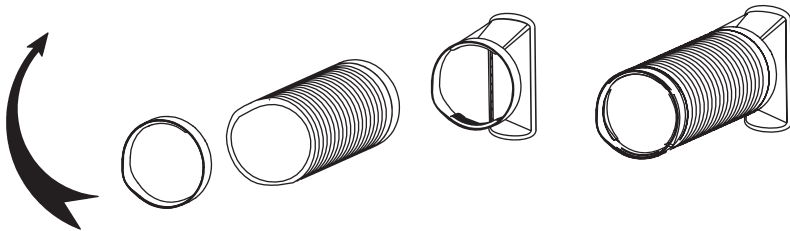

### Note:

DO NOT attach additional hoses to extend the length, as it will decrease the cooling efficiency and may damage the product.

## C. Connect Exhaust Hose To The Product

1. Align the exhaust hose connector with the slots on the exhaust hose fastener on the back of the product.
2. Slide the connector downwards into the exhaust hose fastener until it is firmly attached.

# Installation Instructions

## D. Install Window Adaptor Kit

### Note:

- Window adaptor kit is designed to accommodate either a vertical slide or horizontal slide window.
- If the window opening is shorter than the minimum length of the window adaptor kit, cut the end without the hole until it is short enough to fit in the window opening. DO NOT cut out the hole in the window adaptor kit.

1. Adjust the expansion panel to fit the size of your window opening.
2. Open the window, and place the adaptor panel in the window opening.

**Vertical Slide Window**

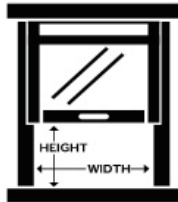

**Horizontal Slide Window**

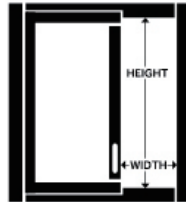

3. Take out the butterfly nut from the accessories bag, and unscrew the nut as shown in the diagram below.

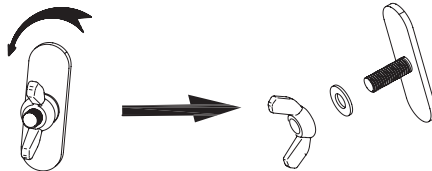

4. Thread the screw through the screw hole on the main adaptor panel, and screw on the butterfly nut, leaving a 2.5mm space.

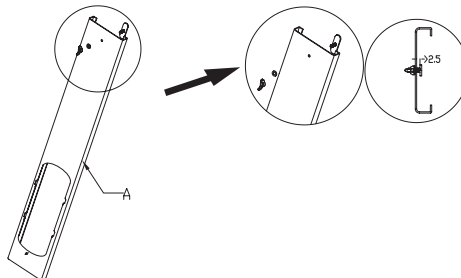

# Installation Instructions

---

- Slide the extension panel between the main panel and the screw's 2.5mm gap and adjust the length needed to cover the window opening.

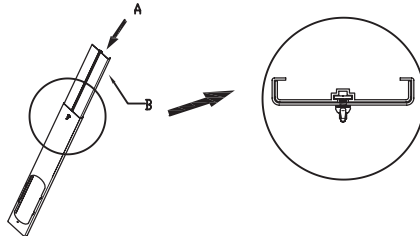

- Screw the butterfly nut tight to secure the adaptor kit.

## E. Connect Exhaust Hose To Window Adaptor Kit

- Close the window till it fits snugly against the window adaptor kit. If necessary, secure the window kit with duct tape.
- Lock the exhaust hose adaptor onto the opening in the window adaptor kit.

### Note:

Place this product close to the window when connecting the exhaust hose. After exhaust hose is connected, move this product away from the window, and keep at least 20 inches (approx. 50cm) empty space between this product and any surrounding wall or object.

- DO NOT allow the exhaust hose to bend or flex more than 45° in order to keep good ventilation of exhaust hose.
- Make sure exhaust hose has been properly installed on both ends before using this product.

# Installation Instructions

## To Use The Air Vent Flap

Aside from the Window Adaptor Kit, exhaust air from the product can be vented outdoors by means of the Air Vent Flap.

1. Separate the Air Vent Adaptor from the Air Vent Flap.

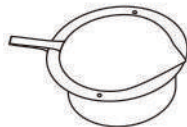

Air Vent Flap



Air Vent Adaptor

2. Bore a hole on the window/wall according to the size of the round end of the Air Vent Flap.
3. Fit the Air Vent Flap onto the window/wall with the flap cover facing inwards. Make sure the flap is securely installed.
4. Screw the hose onto the wider end of the Air Vent Adaptor.
5. When you need to vent the exhaust hose out the window/wall, open the flap cover and fit the Air Vent Adaptor onto the Air Vent Flap.

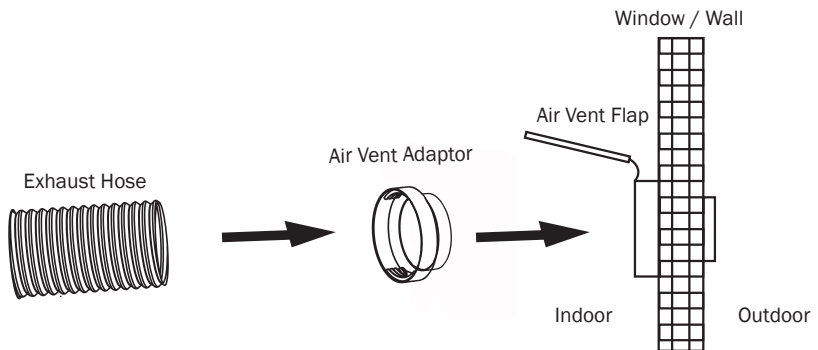

### ⚠ WARNING!

When installing the Air Vent Flap, make sure it is securely installed onto the window/wall. An insecure flap may come loose and cause danger.

# Operation Instructions

## Control Panel

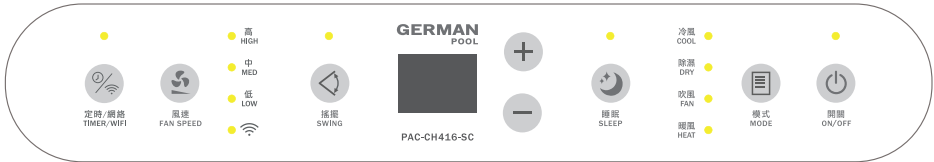

Icon	Description	Icon	Description	Icon	Description
	On/Off Key		Mode Key		Sleep Key
	Increase Key		Decrease Key		Swing Key
	Fan Speed Key		Timer / WiFi Key	高 HIGH	High Fan Speed Indicator Light
中 MED	Medium Fan Speed Indicator Light	低 LOW	Low Fan Speed Indicator Light	冷風 COOL	Cool Mode Indicator Light
除濕 DRY	Dry Mode Indicator Light	吹風 FAN	Fan Mode Indicator Light	暖風 HEAT	Heat Mode Indicator Light
	WiFi Indicator Light				

### Turn On The Product





1. Connect product to the power source. Buzzer beeps once, control panel lights up for 1 second then turns dark, On/Off Indicator Light remains lit, and product enters standby state.
2. Tap On/Off Key to turn on the product; by factory default, product runs in Fan Mode.
3. After using the product, tap On/Off Key to turn off the product (product only returns to standby state, product will still be connected to power).

### Note:

This product has built-in memory. When user presses On/Off Key to turn off the product, next time the product is turned on again, it will run in the previous setting. Even if the product is unplugged, the next time it is plugged in and turned on again, it will still run in the previous setting.

# Operation Instructions

## Mode Selection

1. When product is turned on, tap Mode Key  to cycle among Cool Mode, Dry Mode, Fan Mode and Heat Mode, the corresponding indicator light will light up constant.
2. After selecting your desired mode, tap Increase Key  /Decrease Key  to adjust temperature, and tap Fan Speed Key  to adjust fan speed (temperature is not adjustable in Dry Mode or Fan Mode; fan speed is not adjustable in Dry Mode).
3. Tap Swing Key  to start or stop Swing Function.

Mode	Temperature	Fan Speed	LED Display
Cool Mode	Adjustable from 16 °C-32 °C	Adjustable (High/Medium/Low)	Shows set temperature
Dry Mode	Not adjustable	Low Fan Speed by default, not adjustable	Shows current room temperature
Fan Mode	Not adjustable	Adjustable (High/Medium/Low)	Shows current room temperature
Heat Mode	Adjustable from 16 °C-32 °C	Adjustable (High/Medium/Low)	Shows set temperature



### Note:

- When in Cool Mode but the set temperature is higher than current room temperature, or when in Heat Mode but the set temperature is lower than current room temperature, the product will not run.
- When changing modes, the compressor will delay turn on/turn off for approx. 15-30 seconds.

## Sleep Mode

1. In Cool Mode or Heat Mode, tap Sleep Key  to activate Sleep Mode, all indicator lights go dim.
2. In Sleep Mode, product runs in Low Fan Speed by default, fan speed is not adjustable; temperature is adjustable from 16°C-32°C; and LED Display shows the set temperature.

### Note:



- In Cool Mode, when user turns on Sleep Mode, set temperature will automatically increase by 2 °C (at the rate of 1 °C per hour) then kept constant; in Heat Mode, when user turns on Sleep Mode, set temperature will automatically decrease by 2 °C (at the rate of 1 °C per hour) then kept constant; this is for the purpose of saving energy.
- Sleep Mode is not available when using Dry Mode or Fan Mode.
- In Sleep Mode, tapping Mode Key  or Sleep Key  will exit Sleep Mode.

# Operation Instructions

---



## Off-Timer

To Set Off-Timer (time for product to automatically turn off):



1. Turn on the product, tap Timer / WiFi Key  to enter Timer Settings. Timer Indicator Light lights up constant.
2. Tap Increase Key  /Decrease Key  to set on-timer from 1-24 hr. LED Display blinks timer duration.
3. If product does not receive any commands in 3 seconds, it will automatically confirm timer, and LED Display will switch back to show set temperature (if Cool Mode/Heat Mode has been selected) or show current room temperature (if Dry Mode or Fan Mode has been selected).

## On-Timer

To Set On-Timer (time for product to automatically turn on):

1. In standby state, tap Timer / WiFi Key  to enter Timer Settings. Timer Indicator Light lights up constant.
2. Tap Increase Key  /Decrease Key  to set on-timer from 1-24 hr. LED Display blinks timer duration.
3. If product does not receive any commands in 3 seconds, it will automatically confirm timer, LED Display will show timer countdown.
4. Select mode, fan speed and temperature. When countdown hits zero, product will automatically start to run in user's selected setting.

## Cancel Timer

1. Tap Timer / WiFi Key  to enter Timer Settings, tap Increase Key  /Decrease Key  until the timer reaches "0".
2. If product does not receive any further command in 3 seconds, it will automatically cancel the timer, and Timer Indicator Light will go dark.



# Operation Instructions

## Remote Control

### Note:

- Before using the remote control, place in 2 AAA batteries. DO NOT use rechargeable batteries.
- When changing batteries, both batteries must be replaced together. DO NOT mix new and old batteries.
- If product will not be used for an extended period of time, remove batteries from the remote control and store batteries in a safe place.

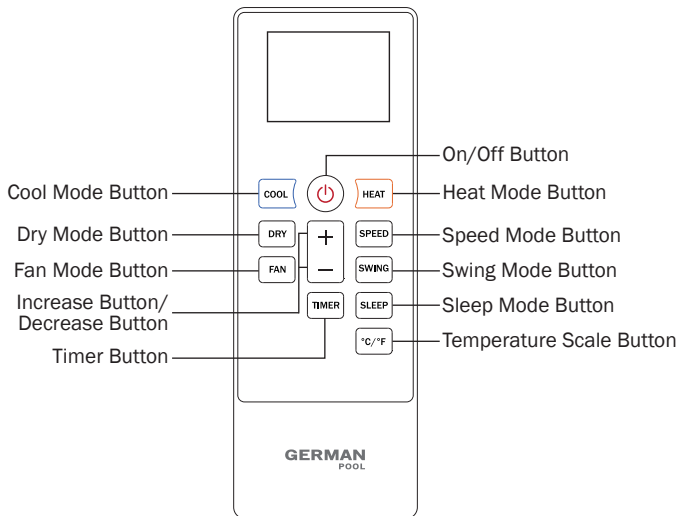

# Operation Instructions

---

## WARNING!

- If the remote control's battery fluid leaks onto skin or clothes, immediately rinse with large amount of water; DO NOT use remote control if battery is leaking.
- If battery fluid is swallowed, gargle and seek medical attention immediately. The chemicals in battery fluid can cause burning or other bodily harm.

Button	Description
On/Off	Press button to turn product on or off (return to standby state)
Heat Mode	Press button to select Heat Mode
Fan Speed	Press button to switch among High/Medium/Low Fan Speed
Swing	Press button to turn Swing Function on or off
Sleep Mode	Press button to select Sleep Mode (available only in Cool Mode or Heat Mode)
Temperature Scale	Press button to change temperature scale display between °C and °F
Cool Mode	Press button to select Cool Mode
Dry Mode	Press button to select Dry Mode
Fan Mode	Press button to select Fan Mode
Increase/Decrease	Press button to adjust temperature (in Cool Mode or Heat Mode) or time (in Timer Settings)
Timer	Press button to enter Timer Settings

# Operation Instructions

---

## Manual Drainage

1. Turn off the product and unplug product from the socket.
2. Place a tray or container (not included with product) under the Condensation Drain Port located at the bottom of the product's backside.
3. Unplug the Condensation Drain Port plug to let the water run out. User may tilt the product slightly to speed up drainage.
4. Re-plug the drain port after all the water has run out.

### Note:

- Be careful not to let the water spill out when moving the product.
- If your container cannot hold all the water, please re-plug the drain port before the container is full, in order to avoid spillage wetting the floor or carpet.
- Make sure the plug has been re-plugged firmly before restarting the product so the new condensation will not spill out.

## Continuous Drainage

1. Unplug the Continuous Drainage Outlet and connect the included drain hose (inner diameter 16mm) securely to the outlet.
2. Let the hose drain into a bucket. DO NOT immerse the hose end into water to avoid causing air lock.

### Note:

- It is recommended NOT to use continuous drainage when product is operating in Cool Mode to ensure adequate water recycles in the unit to enhance the system's cooling effect.
- It is recommended to use continuous drainage when product is operating in Heat Mode or Dry Mode to avoid frequent drainage.
- Make sure the drain hose is not placed higher than the Continuous Drainage Outlet, and that the hose is not bent.

## Compressor Delay Turn-On Protection

Aside from the first time the product is connected to the power source when the compressor may start to run immediately, each time the product is turned off and the compressor stops running, the product will activate a 3-minute delay turn-on safety mechanism whereby even if the product is turned on again immediately, the compressor will not restart until after 3 minutes.

# Operation Instructions

## Connecting The Product To WiFi

This product can be controlled via smartphone with German Pool Smart Control APP.

### Note:

To connect the product to WiFi, please use WiFi with a frequency of 2.4 GHz, does not work with WiFi with a frequency of 5.0 GHz.

## A. How To Set Up The APP

1. Connect your phone to 2.4 GHz WiFi then scan the QR Code below, or search "German Pool Smart Control" in App Store or Google Play to download and install the APP.



Apple iOS System  
App Store



Android System  
Google Play

## B. Change The Language

### Apple IOS System

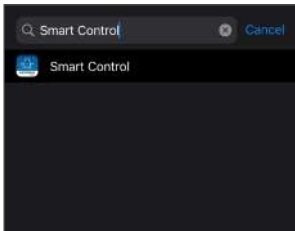

1. Search "Smart Control" in Settings.

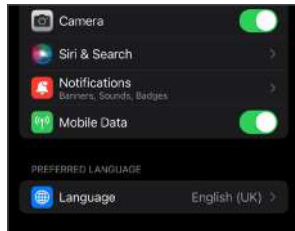

2. Click "Preferred Language".



3. Select Traditional Chinese or English in the "Suggested Languages" column (Note: if user select "Traditional Chinese (Hong Kong)", app will display in English).

### Android System

App will appear in your preset phone language. If you need to change APP language, you need to change the system language in your phone settings.

# Operation Instructions

## C. Register Your Account



1. Open the APP · click “Agree” on “User Agreement and Privacy Policy”.



2. Click “Sign Up” to register your account.



3. Enter your email address, tick “I agree Privacy Policy and User Agreement”, then click “Get Verification Code”.

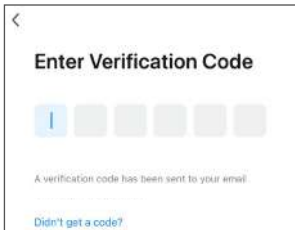

4. Enter one-time verification code from your email.

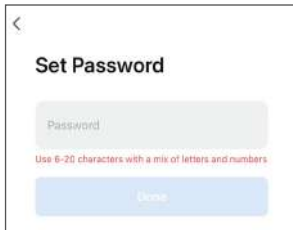

5. Set up your password then click “Done”.

# Operation Instructions

## D. Pairing Sequence

### Method 1: Auto Pairing



1. Long-press the product's Timer/WiFi Button for 5 seconds until buzzer beeps 1 time and WiFi Indicator Light blinks.



2. Click “+” on the upper right corner of the APP homepage, then click “Add Device”.

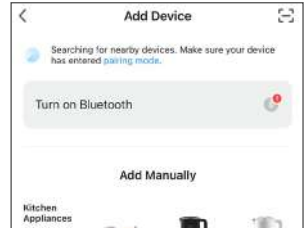

3. Before pairing, user must allow the App to access your Bluetooth. Tap on “Turn on Bluetooth” (if Bluetooth is already on, ignore this step).

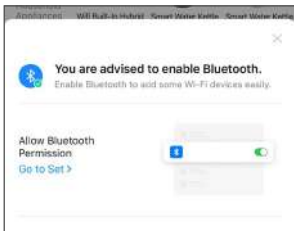

4. Tap “Go To Set” (if Bluetooth is already on, ignore this step).



5. Turn on Bluetooth (if Bluetooth is already on, ignore this step).

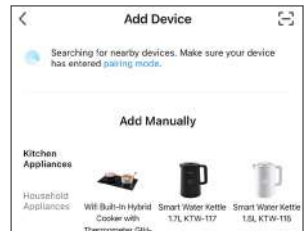

6. APP will show “Searching for nearby devices...”.

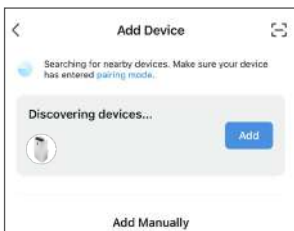

7. APP will show “Discovering devices...”, click “Add”.

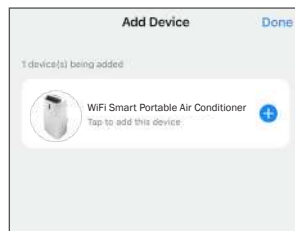

8. Click “+” on the right of product name.

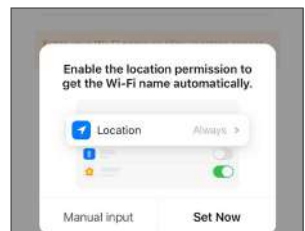

9. it is recommended to allow the APP to access your location. Tap “Set Now” (if Location is already on, ignore this step).

# Operation Instructions

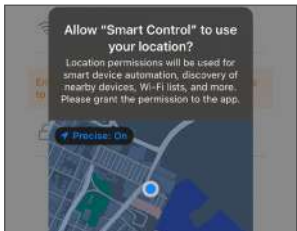

10. Tap “Allow While Using App” (if Location is already on, ignore this step).

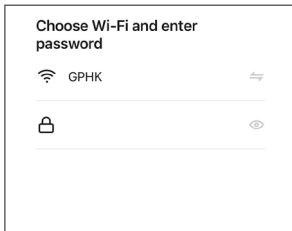

11. Select WiFi name and enter your WiFi password, then click “Next”.

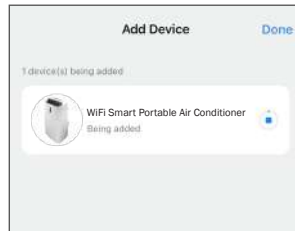

12. APP will show “Being Added”, the product and APP will automatically pair up.

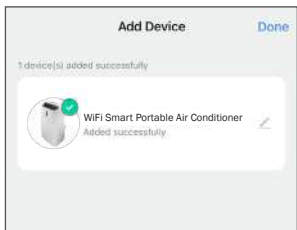

13. When pairing is completed, APP will show “Added successfully”. Click “Done” to return to homepage.

## **⚠ WARNING!**

If Bluetooth is turned off or App is not permitted to access Bluetooth, the product cannot be paired. (Note: Even if Bluetooth is turned on, it does not mean the APP is allowed to access your Bluetooth.)

## **Note:**

- The product can only be paired to one account at a time. If another user pairs their smartphone to the product, the previous account will lose their control of the product.
- User who has already been paired can share their control rights with other users. For details, see “E. Sharing Control”.

## **Note:**

If APP cannot find the product, or during Pairing Sequence, if APP shows an exclamation mark icon, it means pairing is unsuccessful. Please use method 2 below for pairing.

# Operation Instructions

## Method 2: Bluetooth Pairing



1. Click “+” on the upper right corner of the APP homepage, then click “Add Device”.

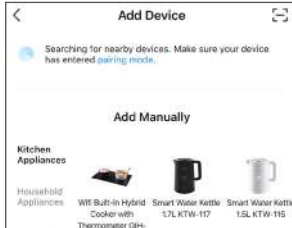

2. In the “Add Manually “ column, find the product model that needs to be paired, and click the product to pair.



3. Follow the instructions on the APP to pair.



4. Click “+” on the right of product name.

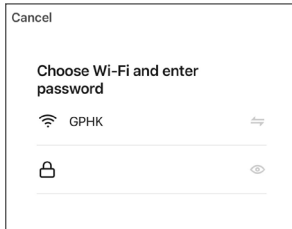

5. Select WiFi name and enter your WiFi password, then click “Next”.

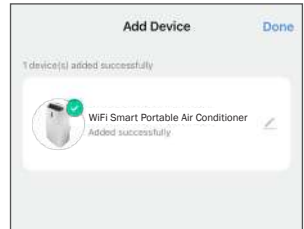

6. When pairing is completed, APP will show “Added successfully”. Click “Done” to return to homepage.

### ⚠ WARNING!

If Bluetooth is turned off or App is not permitted to access Bluetooth, the product cannot be paired. (Note: Even if Bluetooth is turned on, it does not mean the APP is allowed to access your Bluetooth.)



# Operation Instructions

## E. Sharing Control



1. On the product's homepage, click “✎” on the upper right corner.

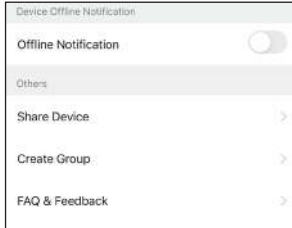

2. Click “Share Device” under “Others”.

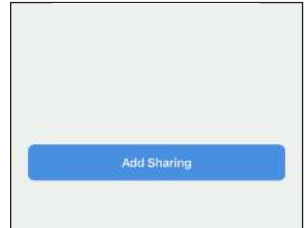

3. Click “Add Sharing”.

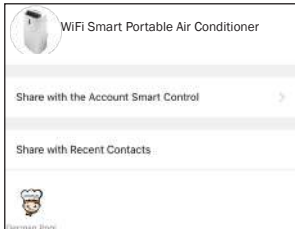

4. Set the number of users with whom you wish to share control, then click “Share with the Account Smart Control”.



5. Enter that account's registered email address, then click “Done” on the upper right corner.



6. Repeat step 3-5 to share with more accounts.

### Note:

On the “Share Device” page, you can add or delete other accounts' control rights.

# Operation Instructions

## Controlling The Product With The APP

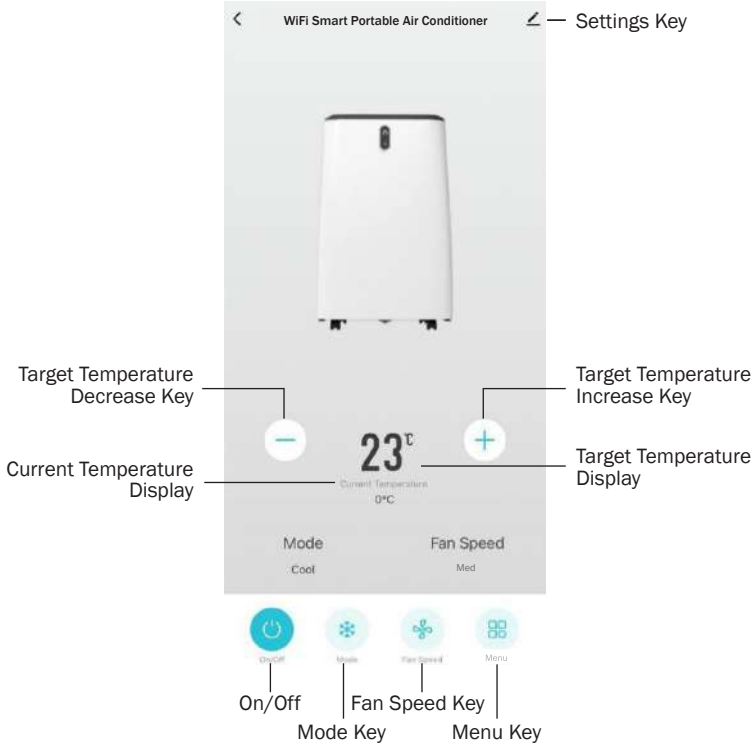

Key	Description
On/Off	<ul style="list-style-type: none"> <li>Tap this key to turn on the product. Tap key 1 time again to turn off the product</li> </ul>
Increase/Decrease	<ul style="list-style-type: none"> <li>Tap Increase Key to increase target temperature by 1°C; tap Decrease Key to decrease target temperature by 1°C</li> <li>Target temperature is adjustable from 16-32°C</li> <li>These keys are not operable in Dry Mode / Fan Mode</li> </ul>
Mode	<ul style="list-style-type: none"> <li>Tap this key then select Cool Mode / Dry Mode / Fan Mode / Heat Mode</li> </ul>
Fan Speed	<ul style="list-style-type: none"> <li>Tap this key then select Low, Medium or High Wind Speed</li> <li>This key is not operable in Dry Mode</li> </ul>
Menu	<ul style="list-style-type: none"> <li>Tap this key then select Timer Function, Sleep Mode, Swing Function or Temperature Scale</li> </ul>

# Operation Instructions

## Timer Function

1. Select Timer Function to enter into Timer Function page. Tap “Add” to enter Timer Setting page (Pic 1).
2. In Timer Setting page, user can set the following parameters (Pic 2):
  - a. Select time.
  - b. “Repeat” section: Select whether you wish to repeat this timer (select day/s of the week; when Timer is turned on, the Portable Air Conditioner will run according to the setting for that specific day of the week).
  - c. “Note” section: Make remark for your own reference.
  - d. “Power” section: Set the timer as On-Timer (time to turn on the product) or Off-Timer (time to turn off the product).
3. After setting is completed, return to Timer Function page. If you wish to add more timers, tap “Add Schedule” at the bottom of the page (Pic 3).

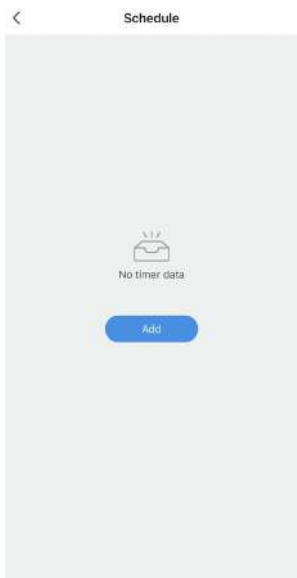

Pic 1

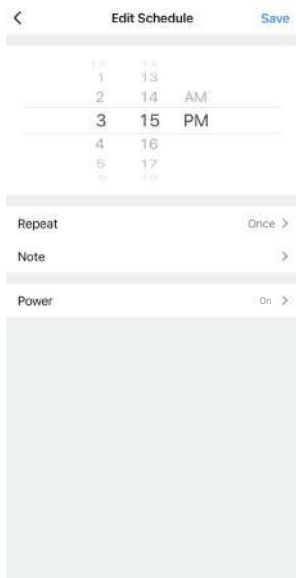

Pic 2

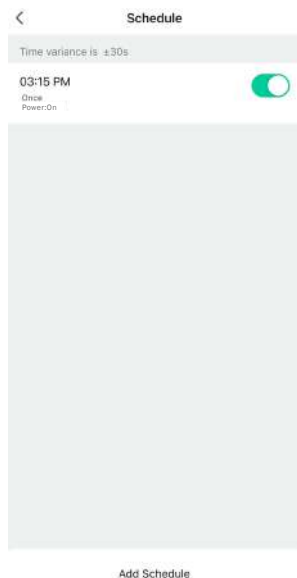

Pic 3

# Operation Instructions

## Sleep Mode

1. Tap Menu Key, then tap the switch on the right of "Sleep Mode" to turn Sleep Mode on and off. Green indicates Sleep Mode is on, grey indicates Sleep Mode is off (Pic 4).
2. Sleep Mode cannot be activated when product is running in Dry Mode or Fan Mode.
3. In Sleep Mode, product runs in Low Fan Speed, fan speed is not adjustable; temperature is adjustable from 16°C-32°C (Pic 5).

## Temperature Scale

Tap Menu Key, then tap "Temperature Scale" to select "°C" or "°F" (Pic 6).

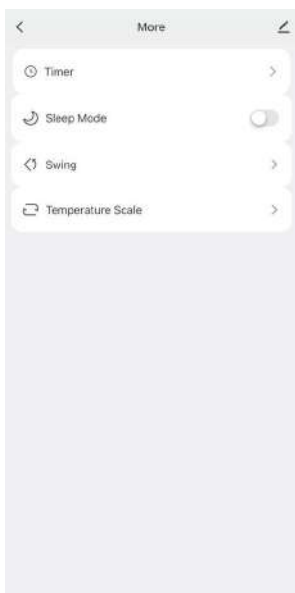

Pic 4



Pic 5

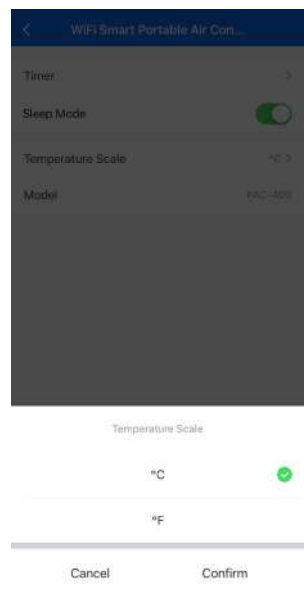

Pic 6

# Cleaning & Maintenance

---

## **WARNING!**

Turn off the product and unplug from the power socket before cleaning and maintenance.

### **Surface Cleaning**

- Unplug the product from the power source before cleaning.
- Wipe product surface with a soft moist cloth. DO NOT use alcohol, gasoline or other chemical solvents to avoid damaging this product. Using thinner, alcohol-glazer or other similar solvents to clean this product is strictly prohibited.
- Use moist soft cloth and neutral detergent to clean the air outlet and louvers. DO NOT use chemical solvents for cleaning, and DO NOT place such solvents near this product.

### **Filter Cleaning**

- It is recommended to clean the filter once every two weeks, otherwise dust may clog the filter and affect the performance of this product.
- Take out the filter, immerse the filter in warm water (about 40°C) diluted with neutral detergent, rinse clean and allow it to air dry completely in the shade.

### **Note:**

- Be careful when taking off the filter, take care not to twist or damage the filter.
- DO NOT squash or scratch the filter with sharp object or brush.
- DO NOT use this product without the filter installed.

## **WARNING!**

DO NOT touch the evaporator surface with bare hands to avoid injury.

### **Storage**

Store this product away properly if it will not be used for an extended period of time.

1. Unplug the Condensation Drain Port on the back of the product and drain off the water completely (user can slightly tilt the product to speed up drainage).
2. Run the product in Fan Mode for 12 hours to let the interior of the product dry out completely in order to prevent the formation of mildew.
3. Turn off the product, unplug from the power socket, bundle up the power cord, re-plug the Continuous Drainage Outlet and Condensation Drain Port.
4. Detach the exhaust hose, clean and let it air dry completely.
5. Remove the batteries from the remote control.

### **Note:**

Store this product and all accessories in its original box, and place it in a dry and ventilated area out of children's reach.

# Troubleshooting

Problem	Possible Cause	Solution
Product does not operate	Power is not connected properly	Insert the plug into the socket properly
	Room temperature too high or too low	This product's working temperature range is 5-35°C
Product is working inefficiently	Filter is dirty	Clean the filter
	Air duct is blocked	Clear blockage
	Window or door is open	Close window or door
	Wrong mode is selected; temperature set too high or too low	Set the correct mode and temperature
	Exhaust hose is detached	Make sure exhaust hose is properly attached
Water leakage	Water spilled when product was moved	Empty water tank before moving the product
	Drain hose is kinked or bent	Straighten the drain hose
Excessive noise	Product is placed on an uneven surface	Place product on horizontal and firm ground
	A certain part is loose and vibrating	Contact German Pool Customer Service & Repair Centre
	Noise sounds like water flowing	Sound made by flowing refrigerant. This is normal
Error Code "E0"	Communication error between main PCB and display PCB	Contact German Pool Customer Service & Repair Centre
Error Code "E1"	Ambient temperature sensor failure	Contact German Pool Customer Service & Repair Centre
Error Code "E2"	Coil temperature sensor failure	Contact German Pool Customer Service & Repair Centre
Error Code "Ft"	Water tank full	Drain off water tank

## **WARNING!**

- DO NOT disassemble or repair this product on your own. Improper repair will cause the warranty to become voided, and may lead to personal injury and property damage.
- If problem persists or for problems not listed in the table above, please contact German Pool Customer Service & Repair Centre for assistance.

# Technical Specification

---

Model	PAC-CH416-SC
Voltage / Frequency	220-240V ~ 50 Hz
Power	1,712 W
Cooling Capacity (BTU)	16,000 BTU
Heating Capacity (BTU)	11,200 BTU
Maximum Allowable Pressure (Low Pressure)	0.7 MPa
Maximum Allowable Pressure (High Pressure)	3.2 MPa
Dehumidification Capacity	31 L/Day
Refrigerant / Charge	R290 / 265 g
Product Dimensions	(H) 785 (W) 355 (D) 455 mm
Net Weight	33.4 kg

- Specification is subject to change without prior notice.
- If there is any inconsistency or ambiguity between the English version and the Chinese version, the English version shall prevail.
- Refer to [www.germanpool.com](http://www.germanpool.com) for the most update version of the user manual.

請即進行保用登記！  
有關保用條款細則，請看說明書最後一頁。

---

Please register your warranty information now !  
For Warranty Terms & Conditions,  
please refer to the last page of this user manual.



# 目錄

---

警告及注意事項 34

產品結構 38

安裝說明 39

使用說明 43

清潔及保養 56

故障檢修 57

技術規格 58

保用條款 59

# 警告及注意事項

## ⚠ 警告！

使用本產品前，請仔細閱讀所有說明。

- 本產品只限家居室內日常使用，如產品作任何商業、工業、出租或其他用途，保用證即告失效。
- 請勿讓兒童或身體有殘障、精神不健全及對本產品缺乏經驗或知識的人士單獨使用本產品；如需使用，必須要在負責任的成年人監管下方可使用。
- 應照顧好兒童，確保他們不會玩耍本產品。
- 無成年人監管下，勿讓兒童清潔及維護本產品。
- 使用前，請先檢查所有電壓是否與本產品標籤上的電壓相符。
- 如果電源線損壞，為免發生意外，電源線必須由廠方、廠方指定的維修中心或同等合格的技術人員進行更換。
- 清潔或檢查本產品前，必須先關機及拔掉插頭。
- 請聯繫德國寶授權的技術人員進行維修或保養本產品。

## ⚠ 警告！

本產品使用易燃製冷劑。如果製冷劑洩漏並接觸到火源或加熱部分，就會產生有害氣體，並有發生火災的危險。



警告！火災危險  
R290



本產品充滿易燃氣體R290。



在使用本產品之前，必須先閱讀說明書。



安裝本產品之前，必須先閱讀說明書安裝部份。



如需維修，請聯繫德國寶客戶服務及維修中心，並嚴格按照製造商的說明進行操作。

為確保安全，必須嚴格遵守以下規定：

1. 本產品適用於8歲以上的兒童，以及身體、感官或智力能力下降或缺乏經驗和知識的人，如果他們得到了有關安全使用本產品的監督或指導，並了解所涉及的危險。兒童不得接觸本產品。未經監督，兒童不得進行清潔和用戶維護。
2. 本產品僅用於使用R-290（丙烷）氣體作為指定製冷劑。
3. 製冷劑迴路已密封。只有合格的專業技術人員方可進行維修。
4. 嚴禁將製冷劑排放到大氣中。
5. R290（丙烷）為易燃物，比空氣重。

# 警告及注意事項

---

1. R290（丙烷）會首先於低處積聚，但可能經由風扇散播。
2. 如懷疑R290（丙烷）洩漏，嚴禁非專業人員試圖查找原因。
3. 本產品使用的R290（丙烷）無氣味，然而沒有氣味並不代表無漏氣。
4. 如檢測到洩漏，必須立即疏散所有人，使房間通風，並聯絡所在地的消防部門，告知他們發生R290（丙烷）洩漏。
5. 在合格的專業技術人員到達，並且由專業技術人員告知可安全返回房間之前，嚴禁讓任何人返回房間。
6. 嚴禁在本產品內部或附近使用明火、香煙或其他可能的火源。
7. 本產品的零部件專為丙烷設計，無刺激性、無火花。所有零部件只能用相同的維修零件更換。
8. 本產品的遙控器包含電池。如果電池被吞下，可能在2小時內造成嚴重的內部燒傷，並可能導致死亡。新電池和舊電池應遠離兒童。如果電池蓋不能安全關閉，請停止使用遙控器，並將其遠離兒童。如果您認為電池可能被吞食或放置在身體任何部位，請立即就醫。電池含有對環境有害的材料；在報廢前，必須將其從設備中取出，並進行安全處理。
9. 不遵守以上警告可能會導致爆炸、死亡、受傷和財產損失。

## **為降低火災、觸電、人身傷害或財產傷害的風險，必須嚴格遵守以下規定：**

1. 如電源線損壞，必須由製造商、其服務代理或具有類似資格的人員更換，以避免發生危險。
2. 維修期間必須斷開本產品與電源的連接。
3. 必須使用產品銘牌上指示的相同電壓、頻率和額定值的電源來操作本產品。
4. 必須使用接地的電源插座。
5. 清潔或不使用本產品時必須拔除電源線。
6. 嚴禁濕手操作本產品，必須防止水濺到本產品上。
7. 嚴禁將本產品浸入或暴露在雨水、濕氣或任何其他液體中。
8. 嚴禁讓本產品在無人看管的情況下運行，嚴禁傾斜或翻轉本產品。
9. 嚴禁在本產品運行期間拔出插頭。
10. 嚴禁通過拉扯電源線的方式拔出插頭。
11. 嚴禁使用拖板或萬能蘇。
12. 嚴禁在本產品上放置任何物品。
13. 嚴禁攀爬或坐在本產品上。
14. 嚴禁將手指或其他物體插入出風口。
15. 嚴禁觸摸機組的進風口或鋁製散熱片。
16. 如本產品掉落、損壞或出現故障跡象，嚴禁操作本產品。
17. 嚴禁使用任何化學品清潔本產品。
18. 必須確保本產品遠離火源、易燃易爆物品。
19. 本產品必須按照所在地區的佈線規定進行安裝。
20. 嚴禁使用製造商推薦以外的方法來加速除霜過程或清潔。

# 警告及注意事項

1. 本產品必須存放在沒有連續運行熱源（例如明火、運行中的燃氣器具或運行中的電加熱器）的房間內。
2. 儲存本產品時，必須防止發生機械損壞。
3. 即使廢棄，嚴禁刺穿或燃燒本產品。
4. 必須注意，製冷劑可能沒有氣味。
5. 必須保護管道免受損壞，嚴禁將本產品安裝在面積小於13m<sup>2</sup>且不通風的房間內。
6. 必須遵守所在地區的燃氣法規。
7. 必須保持所有必要的通風口暢通無阻。
8. 本產品必須放置在通風良好的地方，房間大小應與本產品適用的房間面積相符。

## ⚠ 警告！

- 任何涉及製冷劑迴路工作的人員，都必須持有行業認可的評估機構頒發的有效證書，該證書授權他們有能力根據行業認可的評估規範安全處理製冷劑。
- 必須按照本產品製造商的建議進行維修。維護和修理必須在有能力使用易燃製冷劑的人員的監督下進行。

## 在維修帶有R290的設備時，必須嚴格遵守以下規定：

1. 操作及維修前檢查  
在操作含易燃製冷劑的系統之前，必須進行安全檢查以確保將點燃的風險降至最低。如需維修製冷系統，必須遵守下列預防措施。
2. 工作程序  
工作必須在受控程序下進行，以最大限度地降低工作進行時存在易燃氣體或蒸汽的風險。
3. 工作區域  
所有維修人員和其他工作人員必須了解所開展工作的性質，必須避免在密閉空間內工作，工作空間周圍的區域應被分隔開。通過控制易燃材料確保該區域安全。
4. 檢查是否存在製冷劑  
在工作前和工作期間，必須使用適當的製冷劑檢測器檢查該工作區域，以確保技術人員了解潛在的易燃環境。必須確保所使用的洩漏檢測設備適用於易燃製冷劑，即無火花、充分密封或本質安全。
5. 準備滅火器  
如要對製冷設備或任何相關部件進行任何熱工，必須準備好適當的滅火設備，例如乾粉或二氧化碳滅火器。
6. 無點火源  
當處理的製冷系統的管道內現存或曾經存有易燃製冷劑，嚴禁使用任何有可能導至火燭或爆炸的火源。所有可能性火源，包括吸煙，必須遠離安裝、維修、拆卸及廢棄的地點，因為過程中可能釋出易燃製冷劑。在開始工作之前，應檢查設備周圍的區域，以確保沒有易燃危險或著火風險。必須展示「禁止吸煙」標誌。

# 警告及注意事項

## 7. 通風區

在拆開系統或進行任何熱加工之前，必須確保工作範圍處於露天狀態或通風良好。在進行工作期間，必須保持一定程度的通風。通風環境必須足夠安全地驅散任何釋放的製冷劑，最好能將製冷劑直接在室外排放到大氣中。

## 8. 對製冷設備的檢查

當更換電氣元件時，元件必須適合用途並符合正確的規格。必須時刻遵守製造商的維護和維修指引。如有疑問，請諮詢製造商的技術部門尋求幫助。

安裝使用易燃製冷劑的裝置時，必須進行以下檢查：

- 充注量根據安裝含製冷劑部件的房間大小而定；
- 通風機械和出風口運行正常，沒有阻塞；
- 如果使用間接製冷迴路，則應檢查二次迴路是否存在製冷劑；
- 設備上的標記仍然清晰可見。難以辨認的標記和符號應予以更正；
- 製冷管或部件安裝在不太可能暴露於任何可能腐蝕含有製冷劑的部件的物質的位置，除非部件由本身具有抗腐蝕能力或適當保護以防被腐蝕的材料製成。

## 9. 電氣設備檢查

進行電氣元件的維修和保養前必須先做好事前安全檢查和元件檢查程序。如果存在可能危及安全的故障，則必須先圓滿排除故障後，才可以將電源連接到電路。如果故障不能立即排除，但又需要繼續運行，則必須採用適當的臨時解決方案。而此情況必須報告給設備的所有者，以便通知所有有關人士。

事前安全檢查須包括：

- 有關的電容器已放電：必須以安全的方式進行，以避免產生火花的可能性；
- 在對系統進行充電、恢復或淨化時，沒有帶電的電氣元件和接線暴露在外；
- 有關系統需持續接地。



### 正確處置本產品

此標誌表明該產品不應與其他生活垃圾一起處理。為防止不受控制的廢物處理對環境或人類健康可能造成的危害，請負責任地回收本產品以促進材料資源的可持續再利用。要退回您用過的設備，請聯繫購買本產品的零售商，他們可將本產品用於對環境安全的回收。

# 產品結構

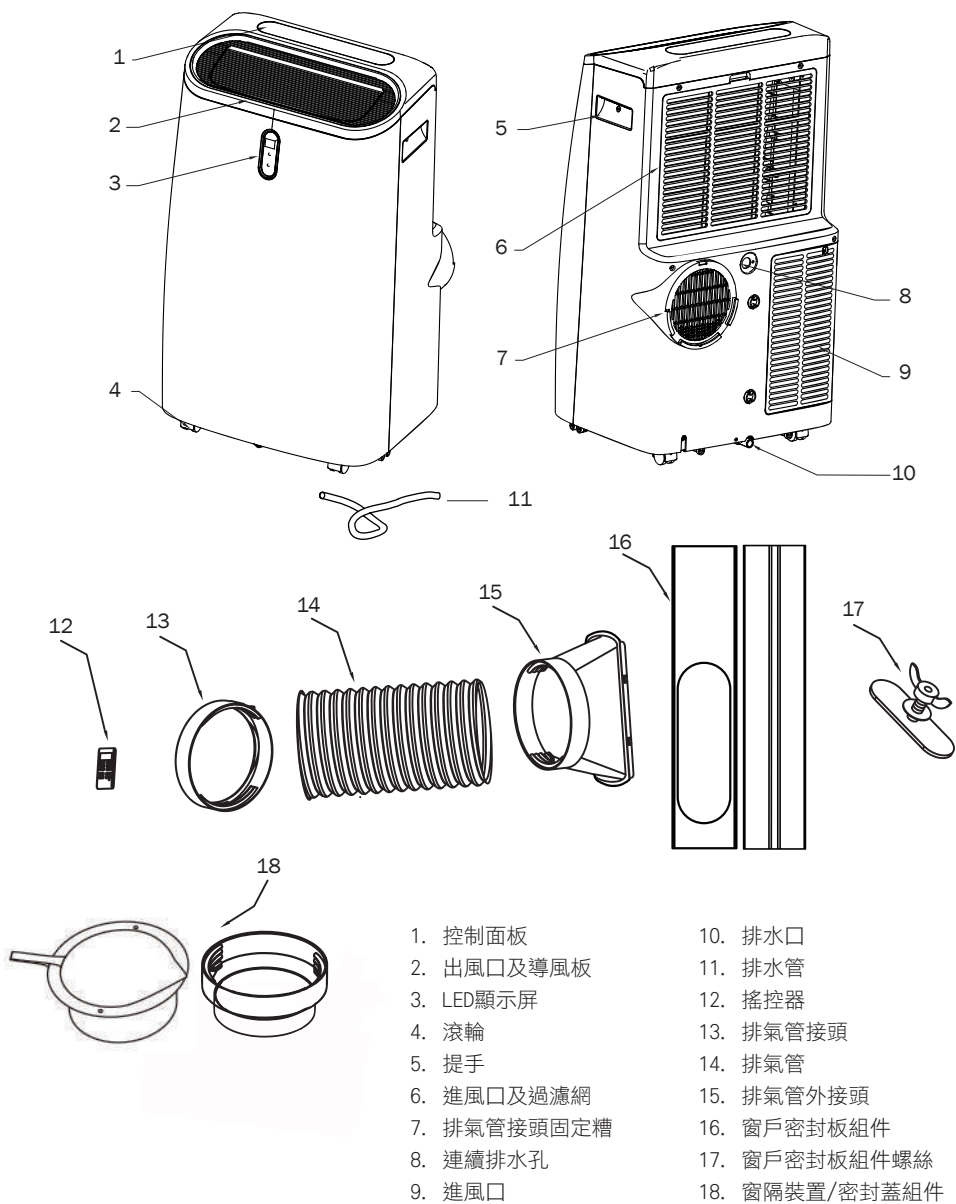

# 安裝說明

## ⚠ 警告！

- 嚴禁將產品安裝在少於13m<sup>2</sup>的房間內。
- 嚴禁將本產品安裝在可能有易燃氣體洩漏的地方。
- 超重危險：建議由兩個或以上的人協助移動和安裝本產品。否則有機會導致背部或其他傷害。
- 搬運或移動本產品時必須握住機身的手柄，並確保本產品時刻處於直立位置。
- 嚴禁握住本產品出風口導風板進行移動。
- 在搬運或移動本產品前，必須將本產品中的水徹底排乾，以防止漏水弄濕地板或地毯。

## 安裝前注意事項

1. 本產品必須放置在堅固的平面上，以儘量減少噪音和振動。為了安全和牢固放置，請將本產品放置在足夠堅固的平穩水平地板上以支撐本機。
2. 本產品配備滾輪用以方便移動，但只能在平滑的平面上滾動。在地毯上滾動時要小心，在木地板上滾動時要小心並保護地板；嚴禁讓本產品滾過任何物體。
3. 本產品必須放置在能夠連接到適當的額定接地插座的地方。

## ⚠ 警告！

觸電危險：必須使用接地的三孔插座；嚴禁透過拉扯電源線從插座上拔下插頭；嚴禁使用萬能蘇；嚴禁使用拖板；否則可能導致死亡、火災或觸電。

4. 嚴禁在本產品的進風口和出風口周圍放置任何物品。嚴禁靠近牆壁、窗簾或其他可能阻擋進出風口的物體，使用本產品時必須保持進風口和出風口暢通無阻。建議周圍至少留有50cm的自由空間，以確保足夠空氣流通。
5. 排氣管可以拉長，但長度建議保持在所需的最短長度。必須確保排氣管沒有任何急轉彎或凹陷。
6. 跟機附送的窗戶密封板組件適用於大多數標準垂直滑動或水平滑動的窗戶，但是，對於其他窗戶類型，可能需要修改安裝程序。
7. 如產品運送時傾斜超過45°，在安裝及啟動前必須將本產品直立擺放至少24小時。
8. 嚴禁將本產品安裝在下列地方或附近使用：
  - 熱源如散熱器、暖爐、火爐或其他產生熱力的物品
  - 陽光直射的地方
  - 有機械震動的地方
  - 灰塵過多的地方
  - 缺乏通風的地方如櫥櫃或書櫃
  - 不平整的表面

## A. 拆除包裝材料

1. 首次使用前必須先拆除包裝材料。
2. 建議保留紙箱和發泡膠包裝，以便在不使用時存放本產品。

# 安裝說明

## 注意：

- 本產品主機內沒有包裝材料可以拆除，嚴禁拆開機身。
- 妥善處理及回收所有包裝材料。
- 必須輕拿輕放，並保持本產品直立和水平。嚴禁將本產品側放或倒置。

## B. 組裝排氣管

1. 握住排氣管的兩端，輕輕拉長排氣管。
2. 將排氣管開口端對準排氣管接頭，順時針旋轉至扣緊。
3. 將排氣管另一開口端對準排氣管外接頭，順時針旋轉至扣緊。

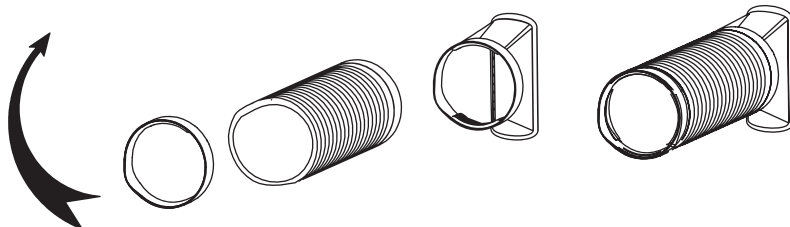

## 注意：

嚴禁連接額外的軟管來延長排氣管長度，避免降低本產品製冷效率，並有可能損壞本產品。

## C. 連接排氣管至機身

1. 將排氣管接頭對準機身背面的排氣管接頭固定槽。
2. 將排氣管接頭向下插入至扣緊，即成。

## D. 安裝窗戶密封板組件

## 注意：

- 窗戶密封板組件適用於垂直滑動或水平滑動的窗戶。
- 如窗戶開口小於窗戶密封板元件的最小長度，請切掉窗戶密封板組件無孔側的末端，使其足夠短以適合窗戶開口。嚴禁切掉窗戶密封板組件中的孔。

1. 按窗戶開口的大小，使用主面板及擴展面板。
2. 打開窗戶，將主面板放入窗戶開口中。

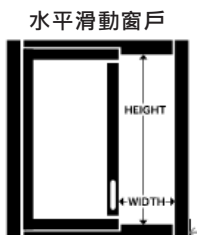
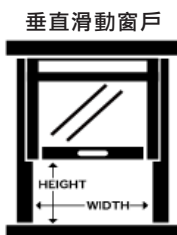



# 安裝說明

3. 使用跟機附送的螺絲，按下圖方法拆開螺絲。

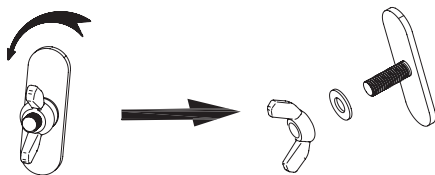

4. 將螺絲扣在主面板上，擰緊螺絲並預留約2.5mm間距的空隙。

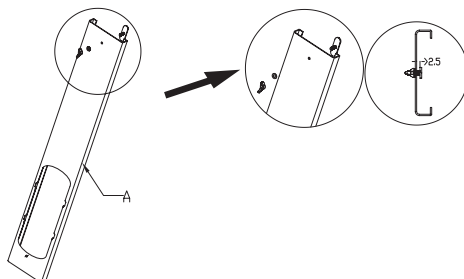

5. 將擴展面板卡入主面板與螺絲之間的空隙，將面板調整成窗口的寬度或高度。

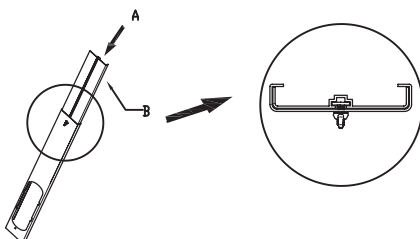

6. 擰緊螺絲以固定窗戶密封板組件。

## E. 連接排氣管至窗戶

1. 將窗戶關閉到與窗戶密封板組件緊貼，完全覆蓋窗戶開口。如有需要，可用膠帶將窗戶密封板組件固定。
2. 將排氣管外接頭對準窗戶密封板組件上的卡槽，扣緊完成安裝。

### 注意：

- 連接排氣管時，本產品必須離窗戶足夠近；連接完成後，將本產品移離牆壁20英寸（約50厘米），並與周圍的物件保持至少20英寸（約50厘米）距離。
- 嚴禁將排氣管彎曲至超過45°，以保持排氣管良好通風。
- 使用前必須確保排氣管已安裝在正確位置及安裝穩妥。

# 安裝說明

## 使用窗隔裝置/密封蓋組件

除窗戶密封板組件之外，亦可使用窗隔裝置/密封蓋組件開孔安裝，以進行排氣。

1. 握住窗隔裝置/密封蓋組件兩端，向外拉拆開成兩個部件。

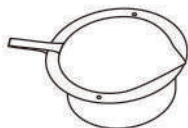

密封蓋組件



窗隔裝置

2. 按照密封蓋組件圓形一端的尺寸在窗戶或牆壁開孔。
3. 將密封蓋組件從窗戶或牆壁內向室外安裝（安裝後密封蓋組件圓形一端在室外，密封蓋在室內），注意檢查是否安裝穩固。
4. 將排氣管安裝在窗隔裝置帶螺紋的一端，排氣管的另一端安裝至機身。
5. 使用時，打開密封蓋，然後將窗隔裝置插入密封蓋組件即可。

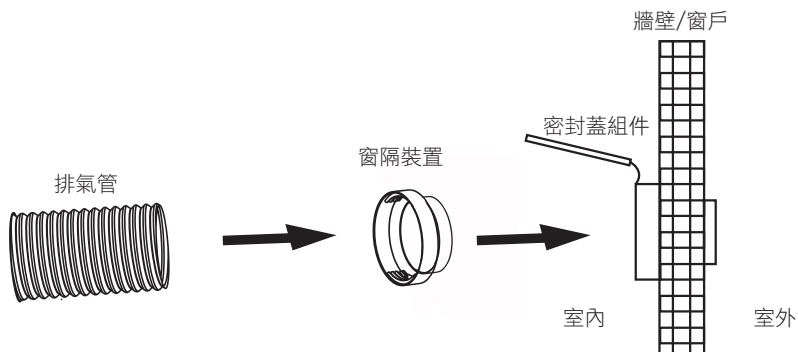

### ⚠ 警告！

安裝窗隔裝置/密封蓋組件時，必須確保安裝穩固而不會鬆脫，以免造成危險。

# 使用說明

## 控制面板

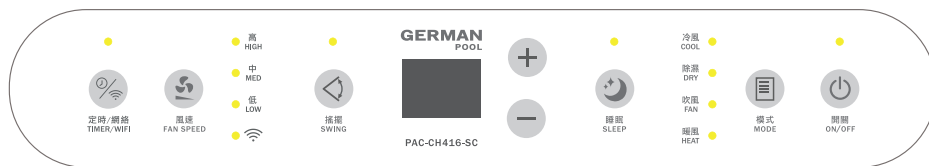

圖標	說明	圖標	說明	圖標	說明
	開關鍵		模式鍵		睡眠鍵
	加鍵		減鍵		搖擺鍵
	風速鍵		定時/網絡鍵	<b>高 HIGH</b>	高風速指示燈
<b>中 MED</b>	中風速指示燈	<b>低 LOW</b>	低風速指示燈	<b>冷風 COOL</b>	冷氣模式指示燈
<b>除濕 DRY</b>	除濕模式指示燈	<b>吹風 FAN</b>	吹風模式指示燈	<b>暖風 HEAT</b>	暖風模式指示燈
	WiFi指示燈				

## 接通電源

1. 連接電源後，蜂鳴器發出提示聲一聲，控制面板全亮1秒後熄滅，電源鍵指示燈常亮，進入待機模式。
2. 按「開關鍵 」開機，首次開機預設以吹風模式運行。
3. 使用完畢後，按「開關鍵 」關機（返回待機狀態，不會斷開本產品與電源的連接）。

## 注意：

本產品設有記憶功能，按「開關鍵 」關機後再重新開機，或斷開電源（拔除電源插頭）後再重新開機，將以上一次關機前的設置繼續運行。

## 選擇模式

1. 開機後按「模式鍵 」循環選擇冷風模式、除濕模式、吹風模式、暖風模式，相應指示燈常亮。
2. 選擇對應模式後，可按「加鍵 /減鍵 」調整溫度；按「風速鍵 」調整風速（溫度調整不適用於除濕模式及吹風模式；風速調整不適用於除濕模式）。
3. 如有需要，可按「搖擺鍵 」開啟或關閉搖擺功能。

# 使用說明

模式	溫度	風速	顯示屏
冷風模式	可調16°C-32°C不	可調高、中、低風速	顯示設定溫度
除濕模式	不可調	預設低風速，不可調	顯示當前室溫
吹風模式	不可調	可調高、中、低風速	顯示當前室溫
暖風模式	可調16°C-32°C	可調高、中、低風速	顯示設定溫度

## 注意：

- 使用冷風模式時如設置溫度高於當前室溫，或使用暖風模式時如設置溫度低於當前室溫，產品將不運作。
- 切換不同模式時，壓縮機將有大約15-30秒延遲啟動或關閉。

## 睡眠模式

1. 在冷風模式或暖風模式下，按「睡眠鍵 

## 注意：

- 在冷風模式下開啟睡眠模式，預設溫度將每小時提高1°C（總共只提升2°C），然後自動恆溫；在暖風模式下開啟睡眠模式，預設溫度將每小時降低1°C（總共只降低2°C），然後自動恆溫，以達至節能省電效果。
- 在除濕模式及吹風模式下，無法使用睡眠模式。
- 如在睡眠模式下，按「模式鍵 

## 定時關機

1. 開機後按「定時/網絡鍵 

## 定時開機

1. 在待機狀態下按「定時/網絡鍵 

## 取消定時

1. 按「定時/網絡鍵 

# 使用說明

## 遙控器

### 注意：

- 使用前請先插入兩節AAA電池；嚴禁使用充電電池。
- 更換電池時，必須同時更換2節電池，嚴禁混用新舊電池。
- 如長時間不使用本產品，必須取出遙控器的電池並妥善存放。

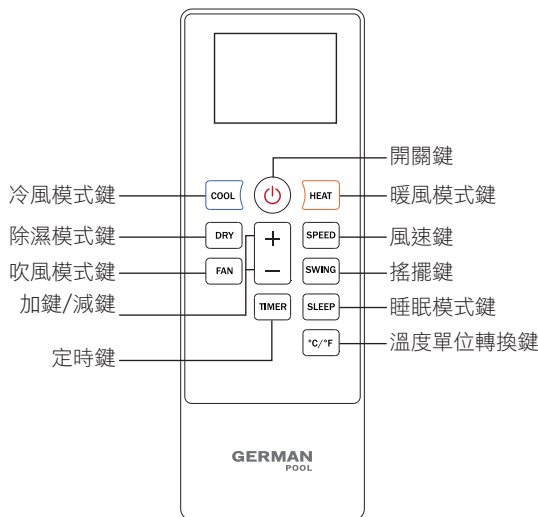

### ⚠ 警告！

- 如遙控器電池液漏到皮膚或衣服上，必須盡快用大量清水沖洗；發現洩漏，嚴禁使用遙控器。
- 如吞下電池液，必須盡快漱口並就醫。電池中的化學物質可能會燃燒或造成其他健康危害。

按鍵	說明
開關鍵	接通電源後按鍵開機或關機（返回待機狀態）
暖風模式鍵	按鍵選擇暖風模式
風速鍵	按鍵選擇高、中、低風速
搖擺鍵	按鍵啟動或關閉搖擺功能
睡眠模式鍵	按鍵進入睡眠模式（只適用於冷風模式及暖風模式）
溫度單位轉換鍵	按鍵切換攝氏或華氏溫度顯示
冷風模式鍵	按鍵選擇冷風模式
除濕模式鍵	按鍵選擇除濕模式
吹風模式鍵	按鍵選擇吹風模式
加鍵/減鍵	按鍵調整溫度（冷風模式及暖風模式下）或調整時間（定時設置下）
定時鍵	按鍵進入定時設置

# 使用說明

---

## 手動排水

1. 將本產品關機並拔除電源插頭。
2. 將托盤或容器（自備）放在機身背面冷凝器排水口下。
3. 打開排水孔的膠塞，將冷凝水完全排出，可輕輕傾斜本產品以加速排水。
4. 將冷凝水排清後，塞上膠塞。

### 注意：

- 移動本產品時必須小心以免漏水。
- 如果容器無法容納所有的水，請在裝滿前盡快堵住冷凝器排水口，以防止漏水弄濕地板或地毯。
- 膠塞必須安裝牢固，以免產品重新開始工作時，新的冷凝水弄濕地板或地毯。

## 連續排水

1. 打開連續排水孔的膠塞，用附送的16mm內徑的排水管連接排水孔。
2. 用水桶盛著排水管流出的水。切勿將水管末端浸於水內，以免形成氣塞。

### 注意：

- 建議避免在冷風模式時使用連續排水，以確保機內有足夠的水循環以增強系統冷卻效果。
- 建議在暖風模式及除濕模式下使用連續排水，避免頻繁手動排水。
- 避免讓排水管高於排水孔，並保持排水管筆直，無任何彎曲。

## 壓縮機延時保護功能

除第一次接通電源後，壓縮機可能立即啟動外，每次關機壓縮機停止運行後，產品進入3分鐘延時再啟動保護，3分鐘內無法再啟動壓縮機。

# 使用說明

## 使用WiFi連接本產品

本產品可透過德國寶智能控制應用程式「German Pool Smart Control」APP以智能手機操控。

### 注意：

必須使用頻率為2.4 GHz的WiFi進行連接，不適用於頻率為5.0 GHz的WiFi。

## A. 下載應用程式

連接頻率為2.4 GHz的WiFi後，掃描下方二維碼，或於蘋果iOS系統上的App Store或安卓Android系統上的 Google Play搜尋「German Pool Smart Control」，下載並安裝APP。



蘋果iOS系統  
App Store



安卓Android系統  
Google Play

## B. 設置APP語言

### 蘋果iOS系統

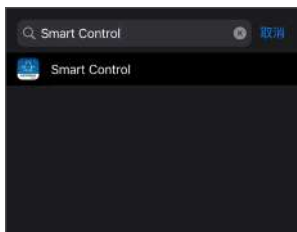

1. 在手機的設定中搜尋「Smart Control」。



2. 點擊「偏好的語言」。



3. 在「建議的語言」一欄中選擇繁體中文或英文（注意：選擇「繁體中文(香港)」APP將會顯示英文）。

### 安卓Android系統

預設為系統所使用的語言，如需更改APP語言，需在設置中更改系統語言。

# 使用說明

## C. 註冊用戶資料



1. 打開APP，點擊「用戶協議與隱私政策」上的「同意」。



2. 點擊「註冊」註冊用戶資料。



3. 輸入電郵地址，剔選「我同意隱私致策與用戶協議」後點擊「獲取驗證碼」。



4. 輸入電郵裡的驗證碼。



5. 設定您的登入密碼後點擊「完成」，完成註冊。



# 使用說明

## D. 配對本產品

### 方法1：自動配對



1. 長按移動空調上的「定時/網絡鍵」3秒，直至蜂鳴器發出提示聲1聲，WiFi指示燈閃爍。



2. 點擊APP主頁右上角「+」，再點擊「添加設備」。



3. 配對前必須先打開藍牙權限，點擊「打開藍牙」（如已打開，可忽略此步驟）。



4. 點擊「去設定」（如已打開，可忽略此步驟）。



5. 點擊藍牙一欄以打開藍牙權限（如已打開，可忽略此步驟）。



6. APP顯示「正在搜索附近的設備...」。



7. 數秒後APP顯示「發現設備...」，點擊「添加」。



8. 點擊產品名稱右方的「+」。



9. 配對時建議開啟位置權限，點擊「立即設置」（如已開啟，可忽略此步驟）。

# 使用說明



10. 點擊「使用App時允許」（如已開啟，可忽略此步驟）。



11. 輸入手機所連接的WiFi名稱及密碼，點擊「下一步」。



12. APP顯示「正在添加」，產品與APP自動配對中。



13. 配對完成後APP顯示「添加成功」，按右上角「完成」進入產品主界面。

## ⚠ 警告！

如沒有開啟藍牙或沒有打開藍牙權限，將無法配對產品；注意，即使電話已開啟藍牙功能，並不代表已打開「藍牙權限」。

## 注意：

- 每次只可以一個帳戶進行配對，如由另一帳戶再次進行配對，先前已配對的帳號將失去本產品的操作權。
- 已配對的帳戶可以分享本產品的操作權予其他帳戶，詳見「E. 操作權分享」部份。

## 注意：

如無法搜索到本產品，或在配對期間APP顯示感嘆號符號，代表配對失敗，請使用下列的方法2進行配對。

# 使用說明

## 方法2：藍牙配對



1. 點擊APP主頁右上角「+」，再點擊「添加設備」。



2. 在「手動添加」一欄找到需要配對的產品型號，點擊該產品進行配對。



3. 按照APP上的指示進行配對。



4. 點擊產品名稱右方的「+」。



5. 輸入手機所連接的WiFi名稱及密碼，點擊「下一步」。



6. 配對完成後APP顯示「添加成功...」，按右上角「完成」進入產品主界面。

### ⚠ 警告！

如沒有開啟藍牙或沒有打開藍牙權限，將無法配對產品；注意，即使電話已開啟藍牙功能，並不代表已打開「藍牙權限」。

# 使用說明

## E. 操作權分享



1. 在本產品操作主界面點擊右上角「」。



2. 在「其他」一欄中點擊「共用設備」。



3. 點擊下方「添加共用」。



4. 在「分享給其他人」一欄中可設定所需分享的人數，再點擊「分享給 SmartControl 賬號」。



5. 輸入該帳戶的註冊電郵地址，再點擊右上角「完成」即可。



6. 重複步驟3-5添加更多其他帳戶。

### 注意：

在「共用設備」頁面裡，你可隨時添加或移除帳戶的操作權。

# 使用說明

## 使用APP操作



按鍵	說明
開關鍵	<ul style="list-style-type: none"> <li>按此鍵開機</li> <li>再按1次關機</li> </ul>
加/減鍵	<ul style="list-style-type: none"> <li>按加鍵增加目標溫度1°C；按減鍵減少目標溫度1°C</li> <li>冷風模式及暖風模式可調節範圍為16-32°C</li> <li>在除濕模式及吹風模式下無法調校溫度</li> </ul>
模式鍵	<ul style="list-style-type: none"> <li>按此鍵後，可選擇「冷風模式」、「除濕模式」、「吹風模式」、「暖風模式」</li> </ul>
風速鍵	<ul style="list-style-type: none"> <li>按此鍵後，可選擇「高風速」、「中風速」或「低風速」</li> <li>在除濕模式下無法調校風速</li> </ul>
選單鍵	<ul style="list-style-type: none"> <li>按此鍵後，可選擇「定時功能」、「睡眠模式」、「搖擺功能」或調校「溫度單位」</li> </ul>

# 使用說明

## 定時功能

1. 選擇「定時功能」後，進入定時功能介面，按「Add」進入定時設置界面（圖1）。
2. 在定時設置界面裡可設置以下內容（圖2）：
  - a. 選擇所需時間。
  - b. 「重複Repeat」欄位：選擇是否需要重複此定時（可選星期一至日，開啟此功能後，移動空調將在所選日子按此設置運行）。
  - c. 「備註Note」欄位：可輸入筆記提示。
  - d. 「電源Power」欄位：將本定時設置定時開機或定時關機。
  - e. 設置完成後，按右上方的「保存Save」確認設置。
3. 完成後返回定時功能介面。如需設置更多定時功能，可按底部的「添加定時Add Schedule」（圖3）。



圖1



圖2

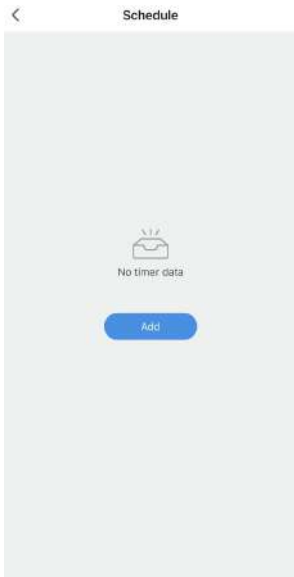

圖3

# 使用說明

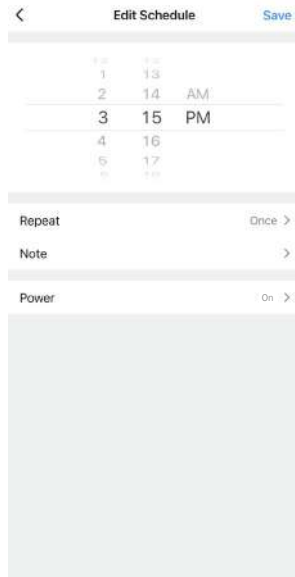
## 睡眠模式

1. 按選單鍵後，再按「睡眠模式」右側的按鈕，綠色代表開啟睡眠模式，灰色代表關閉睡眠模式（圖4）。
2. 在除濕模式及吹風模式下，無法使用睡眠模式。
3. 在睡眠模式下，預設以低風速運行，風速不可調；溫度可調16°C-32°C（圖5）。

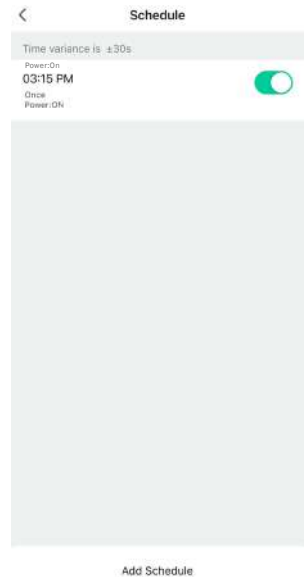
## 調校溫度單位

按選單鍵後，再按「溫度單位」右側的按鈕，可選擇「攝氏°C」或「華氏°F」顯示溫度（圖6）。



圖4



圖5

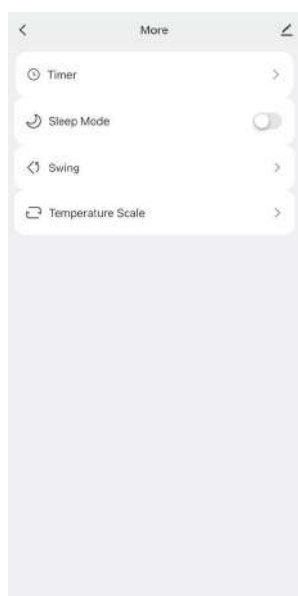

圖6

# 清潔及保養

## ⚠ 警告！

在維修或保養前，必須先關機並拔除電源插頭。

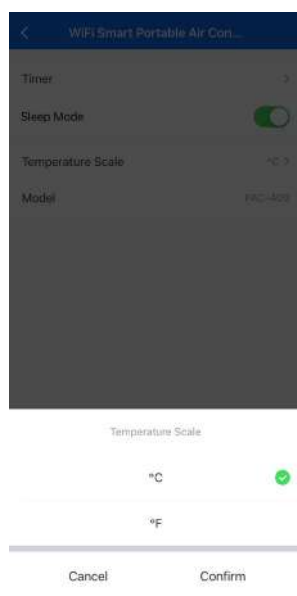
### 清潔產品表面

- 清潔前必須拔除電源插頭。
- 用濕軟布清潔本產品表面，嚴禁使用酒精和汽油等化學溶劑，以免損壞本產品。清潔本產品時嚴禁使用任何稀釋劑、酒精或其他類似溶劑。
- 用濕軟布和中性清潔劑清潔出風口。嚴禁使用任何化學溶劑清洗機身組件或在本產品附近長期放置此類物品。

### 清潔過濾網

- 建議每兩星期清潔一次過濾網，否則過濾網被灰塵堵塞會影響本產品性能。
- 拆出過濾網，將過濾網浸入混有中性清潔劑的溫水（約40°C）中輕輕清洗，然後置於陰涼處晾乾。

### 注意：

- 拉出過濾網時必須小心，避免扭曲或損壞過濾網。
- 嚴禁用尖銳的物體或刷子擠壓或撞擊過濾網。
- 嚴禁在未安裝過濾網的情況下使用本產品。

## ⚠ 警告！

嚴禁接觸蒸發器表面，以免造成受傷。

### 收納本產品

長時間不使用本產品時，請妥善存放。

1. 打開機身背面排水孔的膠塞，將冷凝水完全排出，可輕輕傾斜本產品以加速排水。
2. 使用本產品的「吹風模式」運行約12小時，使機內部件完全乾燥，防止發霉。
3. 關閉本產品並拔除插頭，將電源線收好，裝好排水孔及連續排水孔的膠塞。
4. 拆下排氣管清洗乾淨後置於陰涼處風乾。
5. 從遙控器中取出電池並妥善保管。

### 注意：

確保本產品存放在乾燥的地方。所有配件必須一起妥善保護，並使本產品遠離兒童。



# 故障檢修

故障情況	可能原因	解決方法
產品不運行	電源連接不牢固	將電源線牢固地插入到電源插座中
	室溫過高或過低	本產品工作溫度範圍為5-35°C
產品運行效率降低	過濾網積存污垢	清潔過濾網
	風道堵塞	清除堵塞物
	房間的門窗打開	保持門窗關閉
	選擇錯誤模式或溫度設置過高或過低	設置合適的模式和溫度
	排氣管分離	確保排氣管連接牢固
產品漏水	移動本產品時水溢出	移動前應清空水箱
	排水管扭結或彎曲	拉直排水管
運行噪音過大	產品放在不平整的地面上	將本產品放置在水平和牢固的地面上
	零件鬆動或震動	聯絡德國寶客戶服務及維修中心
	噪音聽起來像是水在流動	噪音來自於流動的製冷劑，屬正常現象
錯誤代碼「E0」	主PCB與顯示PCB通信故障	聯絡德國寶客戶服務及維修中心
錯誤代碼「E1」	環境溫度感測器故障	聯絡德國寶客戶服務及維修中心
錯誤代碼「E2」	線圈溫度感測器故障	聯絡德國寶客戶服務及維修中心
錯誤代碼「Ft」	儲水箱滿水	排清儲水箱內的冷凝水

## ⚠ 警告！

- 嚴禁擅自拆卸或維修本產品，維修不當將使保養失效，並可能對您和您的財產造成傷害。
- 如果產品的問題未在上表中列出，請聯絡德國寶客戶服務及維修中心。

# 技術規格

---

型號	PAC-CH416-SC
電壓/頻率	220-240V ~ 50 Hz
功率	1,712 W
製冷能力 (BTU)	16,000 BTU
製暖能力 (BTU)	11,200 BTU
最高可使用壓力 (低壓)	0.7 MPa
最高可使用壓力 (高壓)	3.2 MPa
除濕量	31 L/Day
製冷劑	R290 / 265 g
產品尺寸	(H) 785 (W) 355 (D) 455 mm
淨重	33.4 kg

- 產品規格及設計如有變更，恕不另行通知。
- 中英文版本如有出入，一概以英文版為準。
- 本產品使用說明書以[www.germanpool.com](http://www.germanpool.com)網上版為最新版本。

# 保用條款

此保用提供德國寶產品之機件在正常使用下壹年保用(自購買日起計算)。

# Warranty Terms & Conditions

Under normal operations, the product will guarantee a 1-year full warranty provided by German Pool (effective from the date of purchase).

\* 貴戶須在購機十天內，以下列其中一種方式向本公司登記資料，保用手續方正式生效：

- 1) 填妥德國寶VIP手機應用程式保用登記表(掃描右方二維碼)
- 2) 填妥本公司網頁保用登記表  
[www.germanpool.com/warranty](http://www.germanpool.com/warranty)
- 3) 填妥保用卡郵寄至本公司。



\* This warranty is not valid until customer registration information is received by our Service Centre within 10 days of purchase via one of the following means:

- 1) Visit our VIP App and register online:  
(Scan the QR Code on the right)
- 2) Visit our website and register online:  
[www.germanpool.com/warranty](http://www.germanpool.com/warranty)
- 3) Complete the attached Warranty Card and mail it back to our Customer Service Centre.



另請填妥以下表格並與正本發票一併保存，以便維修時核對資料。用戶提供之所有資料必須正確無誤，否則免費保用將會無效。 Please fill out the form below. This information and the original purchase invoice will be required for any repairs. Warranty will be invalidated if information provided is found to be inaccurate.

型號 Model No. :  PAC-CH416-SC

機身號碼 Serial No. : \_\_\_\_\_ 發票號碼 Invoice No. : \_\_\_\_\_

購買商號 Purchased From : \_\_\_\_\_ 購買日期 Purchase Date : \_\_\_\_\_

1. 未能出示購買發票正本者，將不獲免費維修服務。
2. 用戶應依照說明書的指示操作。本保用並不包括：
  - 上門安裝、檢驗、維修或更換零件之人工以及一切運輸費用；
  - 因天然與人為意外造成的損壞(包括運輸及其他)；
  - 電源接合不當、不依說明書而錯誤或疏忽使用本機所引致之損壞。
3. 於下列情況下，用戶之保用資格將被取消：
  - 購買發票有任何非認可之刪改；
  - 產品被用作商業或工業用途；
  - 產品經非認可之技術人員改裝或加裝任何配件；
  - 機身編號被擅自塗改、破壞或刪除。
4. 總代理有權選擇維修或更換配件或其損壞部份。
5. 產品一經被轉讓，其保用即被視作無效。

1. Customer who fails to present original purchase invoice will not be eligible for free warranty service.
2. Customer should always follow the operating instructions. This warranty does not apply to:
  - labour costs for on-site installation, check-up, repair, replacement of parts and other transportation costs;
  - damages caused by accidents of any kind (including material transfer and others);
  - operating failures resulting from applying incorrect voltage, improper usage, and unauthorized installations or repairs.
3. This warranty is invalid if:
  - the purchase invoice is modified by an unauthorized party;
  - the product is used for any commercial or industrial purposes;
  - the product is repaired or modified by unauthorized personnel, or unauthorized parts are installed;
  - the serial number is modified, damaged or removed from the product.
4. German Pool will, at its discretion, repair or replace any defective part.
5. This warranty will be void if there is any transfer of ownership from the original purchaser.

## 客戶服務及維修中心

中國香港

九龍大業街59號

三湘九龍灣貨運中心地下B室

電話：+852 2333 6249

傳真：+852 2356 9798

電郵：[repairs@germanpool.com](mailto:repairs@germanpool.com)

中國澳門

澳門青洲大馬路(青洲新路)

515號美居廣場第二期1樓A座

電話：+853 2875 2699

傳真：+853 2875 2661

## Customer Service & Repair Centre

Hong Kong, China

Unit B, G/F, Sunshine Kowloon Bay

Cargo Centre, 59 Tai Yip Street,

Kowloon, Hong Kong

Tel : +852 2333 6249

Fax : +852 2356 9798

Email : [repairs@germanpool.com](mailto:repairs@germanpool.com)

Macau, China

A,1 Andar, Mei Kui Kuong Cheong Fase 2,

No.515 Avenida Do Conselheiro Borja

Macau

Tel : +853 2875 2699

Fax : +853 2875 2661

此保用只適用於香港及澳門

This warranty is valid only in Hong Kong and Macau

# GERMAN POOL

## German Pool (Hong Kong) Limited

### Hong Kong, China

Room 113, Newport Centre Phase II, 116 Ma Tau  
Kok Road, Tokwawan, Kowloon, Hong Kong.  
Tel: +852 2773 2888  
Fax: +852 2765 8215

### Mainland China

8th, Xinxiang Road, Wusha Industrial Park,  
Daliang, Shunde, Foshan, Guangdong  
Tel: +86 757 2219 6888  
Fax: +86 757 2219 6809

### Macau, China

A, 1 Andar, Mei Kui Kuong Cheong Fase 2,  
No.515 Avenida Do Conselheiro Borja, Macau  
Tel: +853 2875 2699  
Fax: +853 2875 2661



香港 (S MARK)  
安全認證



中國經銷家電行業  
十大影響力品牌

CEO

CEO非凡品牌大賞



香港優質商號



香港工商業獎



2007  
最高品質  
創建品牌企業獎



香港中小企業  
最佳拾獲大獎



香港消費者推薦品牌



香港 (O MARK)  
優質服務證書



香港名牌十年成就獎  
HONG KONG TOP BRAND TEN YEAR  
ACHIEVEMENT AWARD

© All rights reserved. Copying, reproducing or using the contents of this manual is not allowed without prior authorization from German Pool, violators will be prosecuted.