

Multi-Capsule Coffee & Tea Maker | CMC-212



Online Warranty Registration



Please read these instructions and warranty information carefully before use and keep them handy for future reference.

USER MANUAL

Table of Contents

Warnings & Safety Precautions 03

Product Structure 06

Operation Instructions 07

Cleaning & Maintenance 09

Troubleshooting 09

Technical Specification 10

Warranty Terms & Conditions 19

Warning & Safety Precautions

WARNING!

Read all instructions carefully before using this product.

- This product is for domestic home indoor use only. If this product is used for any commercial, industrial, rental or other purposes, product warranty will be VOIDED.
 - This product is not intended for use by children or persons with reduced physical, sensory or mental capabilities, or lack of experience and knowledge, unless they have been given supervision or instruction concerning use of this product by an adult responsible for their safety.
 - Mind your children and DO NOT let children play with this product.
 - Cleaning and user maintenance shall not be made by children without supervision.
 - Check the voltage indicated on the rating label before using this product.
 - If the supply cord is damaged, it must be replaced by the manufacturer, its service agent or similarly qualified persons in order to avoid hazards.
 - Unplug this product from the power source before cleaning and maintenance.
 - Contact German Pool authorized service technician for repair or maintenance of this product.
1. Read all instructions and keep these safety instructions. Any type of misuse of the appliance may result in a potential injury.
 2. Connect the appliance to a mains power socket with an earth connection only. Mains voltage must be the same as the details on the rating plate. The use of incorrect connection will negate the guarantee and may be hazardous.
 3. This appliance is intended to be used in household only. It is not intended to be used in following applications, and the guarantee will not apply for:
 - staff kitchen areas in shops, offices and other working environments;
 - farm houses;
 - by clients in hotels, motels and other residential type environments;
 - bed and breakfast type environments;
 4. Your appliance is intended for domestic use inside the home only at an altitude below 3400 m.
 5. In case of any inappropriate use or failure to comply with the instructions, the manufacturer accepts no responsibility and the guarantee may not apply.
 6. DO NOT remove hot capsules by hand. Always use capsule holder handle to dispose of used capsules.
 7. Always use the appliance on a flat, stable, heat resistant surface away from sources of heat or water splashes. This appliance shall not be placed in a cabinet when in use.
 8. To protect against fire, electric shock and injury to persons DO NOT immerse the power cord, plugs or the appliance in water or other liquid. Avoid spillage on the plug. Never touch the power cord with wet hands. DO NOT overfill the water tank.
 9. In case of an emergency remove the plug from the mains power socket immediately.
 10. Close supervision is necessary when the appliance is used near children. Keep the appliance / power cord / capsule holder out of reach of children. Children should be supervised to ensure that they DO NOT play with the appliance. Never leave the appliance without surveillance while making a beverage.

Warning & Safety Precautions

11. This appliance is not intended for use by children or persons with reduced physical, sensory or mental capabilities, or lack of experience and knowledge, unless they have been given supervision or instruction concerning use of the appliance by a person responsible for their safety. Persons who have a limited or no understanding of the operation and use of this appliance must first read and fully understand the contents of the user manual, and where appropriate seek additional guidance on its operation and use from the person responsible for their safety.
12. DO NOT use the appliance without the drip tray and drip grid, except when a very tall mug is used. DO NOT use the appliance for hot water preparation.
13. For health reasons, always fill the water tank with fresh drinking water.
14. After use of the appliance always remove the capsule and clean the capsule holder. Empty and clean the drip tray daily and also the capsule bin (when available). Food allergy sufferers must rinse the appliance according to cleaning procedure.
15. The heating element surface is subject to residual heat after use and plastic housings may feel warm to touch several minutes upon use.
16. Unplug from the mains power socket when not in use.
17. Unplug from the mains power socket before cleaning. Allow to cool before putting on or taking off parts, before cleaning the appliance. Never wet or immerse appliance in any fluid. Never clean the appliance with running water. Never use detergents to clean the appliance. Clean the appliance only using soft sponges/brushes. The water tank should be cleaned with a clean food-safe brush.
18. Never turn the machine upside down.
19. If away for prolonged periods, on holiday, etc. the appliance must be emptied, cleaned and unplugged. Rinse before reuse. Operate the rinse cycle before re-using your appliance.
20. DO NOT turn off the appliance during the descaling process. Rinse the water tank and clean the appliance to avoid any residual descaling agent.
21. Any operation, cleaning and care other than normal use must be under taken by German Pool Customer Service and Repair Centre, and DO NOT put anything into openings.
22. In case of intensive use without allowing sufficient cooling time, the appliance will stop functioning temporarily with the red indicator light blinking. This is to protect your appliance from overheating. Switch the appliance off for 20 minutes to let it cool down.
23. DO NOT operate any appliance with a damaged cord or plug. If the power cord is damaged, it must be replaced by the manufacturer, its service agent or similarly qualified persons in order to avoid a hazard. DO NOT operate any appliance that malfunctions or has been damaged in any manner. Unplug cord immediately. Return the damaged appliance to German Pool Customer Service and Repair Centre.
24. The use of accessory attachments not recommended by the appliance manufacturer may result in fire, electric shock or injury to persons.
25. DO NOT let the cord hang over the edge of a table or counter, or touch hot surfaces or sharp edges. DO NOT allow the cord to dangle (risk of tripping up). Never touch the cord with wet hands.
26. DO NOT place on or near a hot gas or electric burner, or in a heated oven.
27. To disconnect, remove the plug from the mains power socket. DO NOT unplug by pulling the cord.
28. Always insert the capsule holder in the machine to prepare a beverage. DO NOT pull out the

Warning & Safety Precautions

capsule holder before the indicator stops blinking. The appliance will not work if the capsule holder is not inserted.



29. DO NOT put fingers under the outlet during beverage preparation.
30. The capsule holder is equipped with a permanent magnet. Avoid placing the capsule holder near appliances and objects that can be damaged by magnetism, e.g. credit cards, USB drives and other data devices, video tapes, television and computer monitors with picture tubes, mechanical clocks, hearing aids and loud speakers.
31. Keep the appliance and its cord out of reach of children aged less than 8 years. Children shall not play with the appliance.
32. This appliance can be used by children aged from 8 years and above and persons with reduced physical, sensory or mental capabilities or lack of experience and knowledge if they have been given supervision or instruction concerning use of the appliance in a safe way and if they understand the hazards involved.
33. Cleaning and user maintenance shall not be made by children unless they are older than 8 and supervised by an adult.
34. To reduce the risk of fire or electric shock, DO NOT remove the cover. No user serviceable parts inside. Repair should be done by authorized service personnel only.

Product Structure

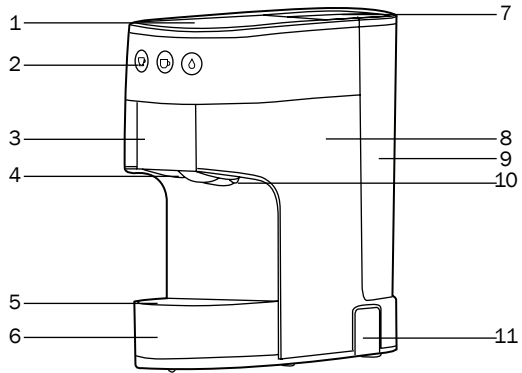
1. Cover
2. Control Panel
3. Capsule Adaptor
4. Coffee Spout
5. Drip Tray Lid
6. Drip Tray
7. Water Tank Lid
8. Body
9. Water Tank
10. Hot Water Spout
11. Milk Frother Interface



Complimentary Capsule Adaptors

		
NES Suitable for Nespresso-type or similar capsules	DG Suitable for Dolce Gusto-type or similar capsules	GROUND COFFEE Suitable for ground coffee

Operation Instructions

Before Use

1. Open the water tank lid, and lift out the water tank from the machine.
2. Fill the water tank with distilled water. DO NOT use hot water, tap water or any other liquid.
3. Install the water tank back onto the machine and close the lid.

Note:

DO NOT fill water tank to above the maximum water mark.

4. Connect the power source. All indicator lights will flash once in blue.
5. Press any key and the product enters preheat status. All indicator lights flash in blue.
Approximately 45 seconds later, all indicator lights will light up constantly in blue, indicating the product has finished preheating and is ready for use.



Place Capsule In Capsule Adaptor

1. Choose the correct capsule adaptor for your capsule.
2. Place capsule or coffee powder in the adaptor.
3. Insert the capsule adaptor into the adaptor slot.
4. Place a suitable cup under the coffee spout.

Note:

DO NOT fill coffee powder to above the maximum mark indicated inside the capsule adaptor, to avoid coffee spilling out during brewing.

Making Coffee or Dispensing Hot Water

Button		Description
	Large cup	<ul style="list-style-type: none">• Press once to make 1 large cup of coffee• Default brewing time is approx. 45 seconds and volume is approx. 80-110ml
	Small cup	<ul style="list-style-type: none">• Press once to make 1 small cup of coffee• Default brewing time is approx. 25 seconds and volume is approx. 40-60ml
	Hot water	<ul style="list-style-type: none">• Press once to dispense 90°C hot water (suitable for brewing green tea)• Press twice to dispense 80°C hot water (suitable for brewing black tea)• Default dispensing time is approx. 35 seconds and volume is approx. 150-200ml

Note:

During dispensing of coffee or hot water, press any key will stop coffee or hot water from dispensing. The time required and quantity produced for different types of coffee may vary.

Operating Instructions

Setting Volume of Coffee or Hot Water

Long-press Large Cup button (20-120 seconds), Small Cup button (15-80 seconds) or Hot Water button (20-120 seconds) to adjust desired coffee or hot water volume:

- After you release the button, the coffee maker will memorize your setting for next time's use.
- If you wish to reset the product to default setting, long-press Large Cup and Small Cup buttons simultaneously until the 2 indicator lights flash 3 times.

Note:

Hot coffee or water will be dispensed as soon as you press the corresponding button. Please have a suitable cup ready on the drip tray, and take care not to place your fingers under the spouts.

Setting Your Coffee Temperature Level

By default, the product will brew coffee at Level 3 temperature. To set a different coffee temperature level, long-press Large Cup and Hot Water buttons simultaneously for 3 seconds to enter Temperature Setting Mode, all indicator lights go dark. Now proceed to set your preferred coffee temperature according to the table below:

Level	Key	Indicator Light
1	Press Small Cup button 2 times	Small Cup indicator light flashes 1 time
2	Press Small Cup button 1 time	Small Cup indicator light flashes 2 times
3	Long-press Small Cup and Large Cup buttons simultaneously for 3 seconds	All indicator lights go dark
4	Press Large Cup button 1 time	Large Cup indicator light flashes 1 time
5	Press Large Cup button 2 times (Wait for indicator light to stop flashing before pressing the second time)	Large Cup indicator light flashes 2 times
6	Press Large Cup button 3 times (Wait for indicator light to stop flashing before pressing the subsequent time)	Large Cup indicator light flashes 3 times
7	Press Large Cup button 4 times (Wait for indicator light to stop flashing before pressing the subsequent time)	Large Cup indicator light flashes 4 times

- For levels 1-2: To change from level 2 to level 1, press Large Cup button once, then press Small Cup button once.
- For levels 4-7: To change to a lower temperature level than the current setting, press Small Cup button once, then choose the level you want according to the table above. (eg. To change from level 7 to level 6, press Small Cup button once, then Large Cup button 3 times).
- After setting your coffee temperature, press Hot Water button to return product to Brewing Mode. All indicator lights will light up constant. Now you can brew a coffee of your choice.

Note:

User must wait till the indicator light stops flashing before pressing again.

Cleaning and Maintenance

WARNING!

Before cleaning and maintenance, turn off the product, unplug the power source, and wait till the product has completely cool down.

Cleaning the Water Tank

Take out the water tank and pour off any residual water, then clean with soft cloth and running water.

Cleaning the Drip Tray and Capsule Adaptors

Take out the drip tray/capsule adaptors, pour off any residual water or coffee grounds, then clean with soft cloth and running water, then wipe dry with dry soft cloth.

Cleaning the Body

Regularly wipe the casing with soft cloth. To ensure user safety, DO NOT let dust or dirt accumulate on the machine, especially on the buttons and the BS plug.

Note:

DO NOT use the dishwasher to clean the accessories or body of this product.

Troubleshooting

Problem	Solution
LED indicators do not light up	Check the electrical parts - BS plug, voltage, fuse and main switch.
No coffee dispensed	<ul style="list-style-type: none">• Check whether the water tank is empty. Fill up the water tank.• Make sure you have chosen the correct capsule adaptor that matches with your capsule type .
No response upon pressing any button	Capsule adaptor is not placed properly. Pull out adaptor and reinsert properly.
Coffee is not hot enough	<ul style="list-style-type: none">• Temperature is set at a low level. Set to a higher temperature level.• Rinse the coffee cup with hot water to warm it up before dispensing the coffee .
Unable to pull out capsule adaptor	Switch off the product to release the inner pressure, then try pulling out the capsule adaptor again.
Abnormal noise	Make sure the water tank is filled and placed properly.
Product turns off by itself	To protect the machine and save energy, the product will automatically switch off when left idle for 8 minutes.
All indicator lights flash in red	Switch off the product, wait 1 minute then restart again.

WARNING!

If problem persists, unplug product from the power source, and contact German Pool Customer Service & Repair Centre. DO NOT disassemble the product unless by a qualified technician.

Technical Specifications

Model	CMC-212
Voltage	230 V
Frequency	50 Hz
Power	1850 W
Water Tank Capacity	1.2 L
Product Dimensions	(H) 250 (W) 105 (D) 290 mm
Net Weight	2.8 kg

- Specification is subject to change without prior notice.
- If there is any inconsistency or ambiguity between the English version and the Chinese version of this manual, the English version shall prevail.
- Refer to www.germanpool.com for the most update version of the user manual.

目錄

警告及注意事項 12

產品結構 14

使用說明 15

清潔與保養 17

故障檢修 17

技術規格 18

保用條款 19

警告及注意事項

⚠ 警告！

使用本產品前，請仔細閱讀所有說明。

- 本產品只限家居室內日常使用，如產品作任何商業、工業、出租或其他用途，保用證即告失效。
- 請勿讓兒童或身體有殘障、精神不健全及對本產品缺乏經驗或知識的人士單獨使用本產品；如需使用，必須要在負責任的成年人監管下方可使用。
- 應照顧好兒童，確保他們不會玩弄本產品。
- 無成年人監管下，勿讓兒童清潔及維護本產品。
- 使用前，請先檢查所有電壓是否與本產品標籤上的電壓相符。
- 如果電源線損壞，為免發生意外，電源線必須由廠方、廠方指定的維修中心或同等合格的技術人員進行更換。
- 清潔或檢查本產品前，必須先關機及拔掉插頭。
- 請聯繫德國寶授權的技術人員進行維修或保養本產品。

1. 使用本產品前，請仔細閱讀所有說明，並妥善保存本說明書。任何錯誤使用本產品的方式皆可能導致人身傷害。
2. 必須將本產品的電源線插入已接地線的插座。所接電源的電壓必須如銘牌所示。任何錯誤連接將令保養失效，並可能導致意外發生。
3. 本產品只適宜在家居室內使用，並不適用於以下用途，同時保養亦不包含以下場所：
 - 店舖、辦公室及其他工作環境之員工廚房；
 - 農舍；
 - 酒店、汽車旅館或其他居住環境；
 - 旅舍類型之環境。
4. 本產品只適宜在處於海拔3400米以下的家居室內使用。
5. 任何不當使用或不按照本說明書所示之方式使用本產品，生產商將不會為此承擔任何責任，而保養亦告失效。
6. 嚴禁用手取出熱的膠囊。必須使用膠囊槽的手柄來移除已使用的膠囊。
7. 必須在平坦、穩固而耐熱的平面上使用本產品，並遠離熱源或被水濺及之處。使用時，嚴禁將本產品放在櫃內。
8. 嚴禁將電源線、插頭或產品機身浸入水或其他液體中，以免發生火警、觸電或造成人身傷害。注意避免傾瀉液體到插頭上。手濕時嚴禁接觸電源線。為水箱注水時嚴禁超過最高水位線。
9. 如遇上任何緊急情況，必須立即從插座拔除插頭。
10. 當在兒童附近使用本產品時，必須嚴密看管。本產品、電源線或膠囊槽必須放置於兒童無法觸及的地方。兒童必須受嚴密看管，以確保他們不會把玩本產品。使用時本產品時，嚴禁無人看管。
11. 請勿讓兒童或身體有殘障、知覺或精神有障礙及對本產品缺乏經驗或知識的人士單獨使用本產品。對本產品缺乏經驗或知識的人士，必須先仔細閱讀及理解說明書上所有內容，並在有需要時向保障其個人安全的人士尋求使用上的指引。
12. 嚴禁在沒有接水盤及接水盤蓋的情況下使用本產品，除非使用高身杯。切勿使用本產品製備熱水。
13. 為健康理由，應往水箱注入新鮮的飲用水。
14. 使用本產品後，必須移除膠囊並清潔膠囊槽。請每天清洗接水盤及膠囊回收桶（如有）。如有

食物敏感之人士，應依照清潔程序清洗本產品。



15. 本產品發熱元件之表面，在使用後仍有餘熱。開始使用數分鐘後，本產品表面可能會發熱。
16. 不使用本產品時，請從電源插座拔除電源線。
17. 清潔前必須拔除電源線。在拆除或裝上產品部件或本產品前，必須讓本產品徹底涼卻。嚴禁向本產品灑水或將產品浸入任何液體中。嚴禁以水龍頭清洗本產品。嚴禁以洗潔精清洗本產品。應使用海綿或軟刷來清潔本產品。水箱應使用符合食品安全的潔淨軟刷清洗。
18. 嚴禁將本產品倒轉擺放。
19. 如將長時間外出，必須將本產品清空、洗淨，並拔除電源線。再次使用前必須先清潔本產品。
20. 嚴禁在除垢過程中關閉本產品。完成後必須沖洗水箱及清潔本產品，以免殘留除垢劑。
21. 任何正常使用以外的清潔、保養及操作應由德國寶客戶服務及維修中心處理及跟進。產品的任何開口處嚴禁存放任何物品。
22. 如果在沒有足夠冷卻時間的情況下頻密使用，本產品的指示燈將以紅色閃爍，代表本產品將短暫停止運行，以防止本產品過熱。關掉本產品20分鐘以待其冷卻。
23. 如電源線或插頭損壞，必須立即停止使用本產品，並由製造商、其服務代理或同類的合資格人員進行維修或更換電源線以避免危險。嚴禁使用任何出現故障或有任何損壞的設備，必須立即拔除電源線，並聯繫德國寶客戶服務及維修中心。
24. 使用非電器製造商推薦的配件可能會導致火災、觸電或人身傷害。
25. 嚴禁讓電源線懸在桌子或櫃檯的邊緣，或接觸高溫表面或鋒利邊緣。嚴禁讓電源線懸垂，以免絆倒。嚴禁用濕手觸摸電源線。
26. 嚴禁將本產品放置在高溫的氣體爐或電爐上，或熱的焗爐中。
27. 如要切斷電源，從插座中拔除插頭。嚴禁以拉扯電源線的方式來拔除插頭。
28. 嚴禁在沒有膠囊槽的情況下使用本產品。在指示燈停止閃爍前，嚴禁拉出膠囊槽。如果未正確插入膠囊槽，本產品將無法運作。
29. 使用時，嚴禁將手指放在出水口下。
30. 膠囊槽配有磁鐵。嚴禁將膠囊槽放置於可能被磁性損壞的電器和物體附近，例如信用卡、USB儲存器和其他數據設備、錄影帶、帶顯像管的電視和電腦螢幕、機械時鐘、助聽器和擴音器。
31. 將本產品及其電源線放置於8歲或以下兒童接觸不到的地方。兒童不得玩耍本產品。
32. 8歲或以上兒童或身體有殘障、知覺或精神有障礙及對本產品缺乏經驗或知識的人士，可以在足夠監管及指導，及對潛在危機有充足理解下，安全使用本產品。
33. 兒童在8歲或以上及在成人監督下，可以對本機進行清潔保養。
34. 為減低火災或觸電風險，請勿取下面蓋。嚴禁自行進行維修，必須由授權的服務人員進行維修。

產品結構

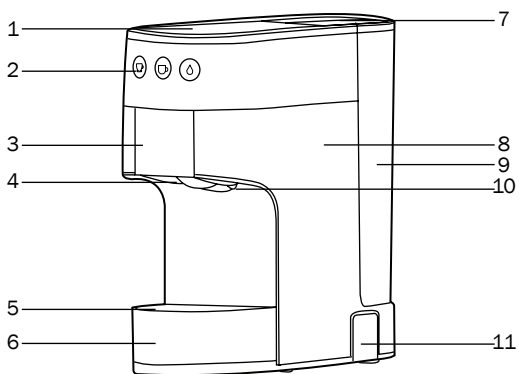
1. 頂蓋
2. 控制面板
3. 膠囊槽
4. 咖啡出口
5. 接水盤蓋
6. 接水盤
7. 水箱蓋
8. 機身
9. 水箱
10. 熱水出口
11. 奶泡機接口



隨機附送膠囊槽

		
NES 適用於nespresso-type或同款之 膠囊	DG 適用於dolcegusto-type或同款之 膠囊	GROUND COFFEE 適用於已研磨的乾燥咖啡粉

使用說明

使用前準備事項

1. 打開水箱蓋，從機身取出水箱。
2. 將水箱注滿，只可注入純淨水，嚴禁注入熱水、自來水或其他液體。
3. 將水箱裝回機身，蓋上水箱蓋。

注意：

注水時嚴禁超越最高水位線。

4. 接通電源後，所有按鍵指示燈以藍色閃爍一次。
5. 按任何鍵後所有按鍵指示燈以藍色閃爍進入預熱狀態，約45秒後所有按鍵指示燈以藍色常亮，代表本產品已預熱完成。



把膠囊放入膠囊槽

1. 根據咖啡膠囊種類選擇合適的膠囊槽。
2. 在膠囊槽放入研磨咖啡粉或咖啡膠囊。
3. 將膠囊槽裝回咖啡機相應位置。
4. 將咖啡杯放在咖啡出口下方盛載咖啡。

注意：

置入咖啡粉時，嚴禁超過咖啡槽內的上限線，避免沖製時咖啡溢出。

沖製咖啡或取熱水

按鍵	說明
 大杯鍵	<ul style="list-style-type: none">• 按鍵一次沖製大杯咖啡• 預設製作時間約為45秒，可沖製出約80-110毫升咖啡
 小杯鍵	<ul style="list-style-type: none">• 按鍵一次沖製小杯咖啡• 預設製作時間約為25秒，可沖製出約40-60毫升咖啡
 熱水鍵	<ul style="list-style-type: none">• 按鍵一次取90°C 熱水（適合沖製綠茶）• 按鍵兩次取80°C 熱水（適合沖製紅茶）• 預設取水時間約為35秒，可取約150-200毫升熱水

注意：

沖製咖啡或取熱水期間，再按任何鍵可停止沖製咖啡或取熱水。
咖啡類型不同，所需沖製時間及份量可能不同。

使用說明

設置咖啡或熱水份量

長按大杯鍵（20秒至120秒）、小杯鍵（15秒至80秒）或熱水鍵（20秒至120秒）調整每次沖製咖啡的份量或取熱水份量：

- 鬆開按鍵後，咖啡機將記錄製作時長，並套用至下次製作咖啡或取熱水。
- 如需重設為默認設置，同時長按大杯鍵和小杯鍵，直至該兩個按鍵指示燈閃爍三次即可。

注意：

調整份量時，咖啡機會因應所按的按鍵沖製咖啡或出熱水；請準備合適的咖啡杯，注意不要將手指放在出水口下方。

設置咖啡溫度檔位

咖啡機預設以第3檔溫度（出廠設置）沖製咖啡。如需設置不同的沖製溫度，請在確保出廠設置的狀態下，同時長按大杯鍵及熱水鍵3秒進入「溫度設置模式」，所有按鍵指示燈熄滅。然後按下表進行設置。

溫度檔位	按鍵	按鍵指示燈
1	按小杯鍵2次	小杯鍵指示燈閃爍1次
2	按小杯鍵1次	小杯鍵指示燈閃爍2次
3	出廠設置（長按小杯鍵及大杯鍵3秒）	所有按鍵指示燈閃爍3次
4	按大杯鍵1次	大杯鍵指示燈閃爍1次
5	按大杯鍵2次 （按鍵後需待指示燈閃爍完畢後再次按鍵）	大杯鍵指示燈閃爍2次
6	按大杯鍵3次 （按鍵後需待指示燈閃爍完畢後再次按鍵）	大杯鍵指示燈閃爍3次
7	按大杯鍵4次 （按鍵後需待指示燈閃爍完畢後再次按鍵）	大杯鍵指示燈閃爍4次

- 設置1-2檔時，如要從1檔調整至2檔，請按大杯鍵1次，再按小杯鍵1次。
- 設置4-7檔時，如要降低至比當前設置更低的檔位，請按小杯鍵1次，再按大杯鍵選擇所需檔位（例如從第7檔降為第6檔：按小杯鍵1次，再按大杯鍵3次）。
- 設置完成後，按熱水鍵確認，所有指示燈常亮後可沖泡咖啡。

注意：

按鍵後需等到指示燈閃爍完畢後再次按鍵。

清潔與保養

⚠ 警告！

清潔咖啡機前請必須關機並拔出電源插頭並將機身完全涼卻。

水箱

取出水箱，倒掉餘下的水，用軟布、清水清洗。

接水盤及膠囊槽

取出來並倒掉殘餘水或咖啡殘渣，用軟布、清水清洗並擦乾。

外殼

定期用軟布擦拭機器表面。保持機器乾淨，特別是按鍵及插頭，以策安全。

注意：

所有部件均不可用洗碗碟機清洗。

故障檢修

故障	解決方法
燈不亮	檢查電源，如插頭、電壓、保險絲和主開關。
不出咖啡	<ul style="list-style-type: none">· 如水箱已空請注滿水箱。· 確保所選膠囊槽與咖啡類型一致。
按鍵無反應	膠囊槽未放置妥當。拉出再裝回膠囊槽，確保正確插入。
咖啡不夠熱	<ul style="list-style-type: none">· 溫度已設為低溫。· 咖啡杯在盛載咖啡前先用熱水沖洗。· 根據咖啡溫度設置說明重新設置咖啡溫度。
膠囊槽拿不出來	關閉本產品以釋放機器內部壓力，再試著取出膠囊槽。
有較大噪音	確保水箱已注滿水且水箱放置妥當。
自動關閉	為保護機器及節約能源，8分鐘內無任何操作，將自動關機。
所有燈以紅色閃爍	關閉本產品，一分鐘後再重啟。

⚠ 警告！

如無法順利排除故障，請與客戶服務及維修中心聯絡，嚴禁非專業人員對本機拆卸。

技術規格

型號	CMC-212
電壓	230 V
頻率	50 Hz
功率	1850 W
水箱容量	1.2 L
機身尺寸	(H) 250 (W) 105 (D) 290 mm
淨重	2.8 kg

- 產品規格及設計如有變更，恕不另行通知。
- 中英文版本如有出入，一概以英文版為準。
- 本產品使用說明書以 www.germanpool.com 網上版為最新版本。

保用條款

此保用提供德國寶產品之機件在正常使用下壹年保用(自購買日起計算)。

Warranty Terms & Conditions

Under normal operations, the product will guarantee a 1-year full warranty provided by German Pool (effective from the date of purchase).

* 貴戶須在購機十天內，以下列其中一種方式向本公司登記資料，保用手續方正式生效：

1) 填妥本公司網頁內之保用登記表格

www.germanpool.com/warranty

2) 填妥保用登記卡，郵寄至本公司。



* This warranty is not valid until customer registration information is received by our Service Centre within 10 days of purchase via one of the following means:

1) Visit our website and register online:

www.germanpool.com/warranty

2) Complete all the fields on the attached Warranty Card and mail it back to our Customer Service Centre.



另請填妥以下表格並與正本發票一併保存，以便維修時核對資料。用戶提供之所有資料必須正確無誤，否則免費保用將會無效。 Please fill out the form below. This information and the original purchase invoice will be required for any repairs. Warranty will be invalidated if information provided is found to be inaccurate.

型號 Model No. : CMC-212

機身號碼 Serial No. : _____ 發票號碼 Invoice No. : _____

購買商號 Purchased From : _____ 購買日期 Purchase Date : _____

- 未能出示購買發票正本者，將不獲免費維修服務。
- 用戶應依照說明書的指示操作。本保用並不包括：
 - 上門安裝、檢驗、維修或更換零件之人工以及一切運輸費用；
 - 因天然與人為意外造成的損壞(包括運輸及其他)；
 - 電源接合不當、不依說明書而錯誤或疏忽使用本機所引致之損壞。
- 於下列情況下，用戶之保用資格將被取消：
 - 購買發票有任何非認可之刪改；
 - 產品被用作商業或工業用途；
 - 產品經非認可之技術人員改裝或加裝任何配件；
 - 機身編號被擅自塗改、破壞或刪除。
- 總代理有權選擇維修或更換配件或其損壞部份。
- 產品一經被轉讓，其保用即被視作無效。

- Customer who fails to present original purchase invoice will not be eligible for free warranty service.
- Customer should always follow the operating instructions. This warranty does not apply to:
 - labour costs for on-site installation, check-up, repair, replacement of parts and other transportation costs;
 - damages caused by accidents of any kind (including material transfer and others);
 - operating failures resulting from applying incorrect voltage, improper usage, and unauthorized installations or repairs.
- This warranty is invalid if:
 - the purchase invoice is modified by an unauthorized party;
 - the product is used for any commercial or industrial purposes;
 - the product is repaired or modified by unauthorized personnel, or unauthorized parts are installed;
 - the serial number is modified, damaged or removed from the product.
- German Pool will, at its discretion, repair or replace any defective part.
- This warranty will be void if there is any transfer of ownership from the original purchaser.

客戶服務及維修中心

香港

九龍大業街59號

三湘九龍灣貨運中心地下B室

電話：+852 2333 6249

傳真：+852 2356 9798

電郵：repairs@germanpool.com

澳門

澳門俾利喇街145號

寶豐工業大廈3樓

電話：+853 2875 2699

傳真：+853 2875 2661

Customer Service & Repair Centre

Hong Kong

Unit B, G/F, Sunshine Kowloon Bay

Cargo Centre, 59 Tai Yip Street, Kowloon

Kowloon, Hong Kong

Tel : +852 2333 6249

Fax : +852 2356 9798

Email : repairs@germanpool.com

Macau

3/F, Edificio Industrial Pou Fung,

145 Rua de Francisco Xavier Pereira,

Macau

Tel : +853 2875 2699

Fax : +853 2875 2661

此保用只適用於香港及澳門

This warranty is valid only in Hong Kong and Macau

German Pool (Hong Kong) Limited

Hong Kong

Room 113, Newport Centre Phase II, 116 Ma Tau
Kok Road, Tokwawan, Kowloon, Hong Kong.
Tel: +852 2773 2888
Fax: +852 2765 8215

China

8th, Xinxiang Road, Wusha Industrial Park,
Daliang, Shunde, Foshan, Guangdong
Tel: +86 757 2219 6888
Fax: +86 757 2219 6809

Macau

3/F, Edificio Industrial Pou Fung,
145 Rua de Francisco Xavier Pereira, Macau
Tel: +853 2875 2699
Fax: +853 2875 2661



香港《S MARK》
安全認證



中國標榜/家電行業
十大影響力品牌



CEO非凡品牌大賞



香港優質商標



香港工商業獎



2007
最具潛質
創星品牌企業獎



香港中小企業
最佳拍檔大獎



HONG KONG
CONSUMER CHOICE
2007



香港《Q標》
優質服務證書



香港名牌十年成就獎
HONG KONG TOP BRAND TEN YEAR
ACHIEVEMENT AWARD

© All rights reserved. Copying, reproducing or using the contents of this manual is not allowed without prior authorization from German Pool, violators will be prosecuted.