

Dehumidifier | DHM-914



Online Warranty Registration



Please read these instructions and warranty information carefully before use and keep them handy for future reference.

USER MANUAL

請即進行保用登記！
有關保用條款細則，請看說明書最後一頁。

Please register your warranty information now !
For Warranty Terms & Conditions,
please refer to the last page of this user manual.

Table of Contents

Warnings & Safety Precautions	04
Product Structure	07
Operating Instructions	08
Cleaning & Maintenance	13
Troubleshooting	14
Product Specification	15
Warranty Terms & Conditions	27

Warnings & Safety Precautions

Do not use this unit for functions other than those described in this instruction manual.

1. Children or persons with reduced physical, sensory or mental capabilities are forbidden to use this appliance unless under supervision.
2. This appliance is only intended for indoor home use only. DO NOT use this appliance for any other purpose.
3. If the supply cord is damaged, it must be replaced by the manufacturer, its service agent or similarly qualified technicians using genuine replacement parts in order to avoid a hazard.
4. Do not disassemble or modify the appliance or the power cord, it is highly dangerous and can result in electric shock or fire.
5. If the appliance needs repair, please contact the manufacturer's authorized repair centre, and use only original parts. Unauthorized reparation work is dangerous and will render the warranty void.
6. It is not recommended to let children or persons with reduced capabilities using this appliance without proper supervision.
7. Children should be supervised to ensure that they do not play with the appliance.
8. This appliance must be properly earthed. All wiring inspection must be carried out by qualified electricians only.
9. DO NOT use this product outdoors.
10. DO NOT block the air inlet and outlet.
11. DO NOT use this appliance with an extension cord
12. Unplug the power cord before cleaning or maintenance of this product.
13. DO NOT pull on the cord to move the product.
14. DO NOT install this product in a room with natural gas, gasoline or sulfur, and DO NOT install product near a heat source.
15. DO NOT use this product on a slanted or un-level surface.
16. Keep product at least 50cm away from flammable substance (eg. alcohol) or durable containers (eg. aerosol canister).
17. DO NOT place heavy items or heat-generating items on top of the product.
18. Clean the filter regularly.
19. Always transport your appliance in a vertical position and place it close to the wall for support. Always empty the water tank before moving the product. After transportation, wait 30 minutes before plugging and turning on the product.
20. R134a / R410A is a refrigerant that complies with European ecological standards; nevertheless, it is recommended not to pierce the cooling circuit of the machine. At the end of its useful life, deliver the appliance to a special waste collection centre for disposal.
21. The packaging is recyclable, so it is recommended that you put them in the corresponding recycling bins.
22. The installation of this product must be consistent with relevant regulations.
23. The model specification of the fuse is: 3.15A 250V.

Warnings & Safety Precautions

Electrical Connections

If product has been moved, please wait 30 minutes before restarting the product. Before plugging the appliance into the mains socket, check that:

1. The mains power supply corresponds to the value indicated on the rating plate on the back of the appliance.
2. The power socket and electrical circuit are adequate for the appliance.
3. The mains socket matches the plug. If this is not the case, have the plug replaced.
4. The mains socket is adequately earthed.
5. The power cords of this product must only be replaced by authorized personnel only.

Warnings & Safety Precautions

Location Requirements

It is forbidden to use this product in a small and enclosed area (eg. closet). If used in a small enclosed area, please keep the door slightly ajar to ensure adequate circulation of air in and out of the area.

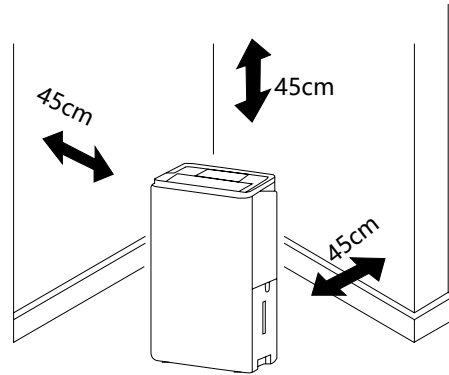

1. Do not use outdoors.
2. This appliance is intended for indoor use only. Place the appliance on a smooth, level floor surface that is strong enough to support the unit with a full bucket of water.
3. Allow at least 45cm of around and above space away from the wall for efficient working.
4. Place the appliance in an area where the temperature will not fall below 5°C.
5. When the product is used in cooking, laundry, bathing and dish-washing areas, the amount of water extracted will be higher.
6. Place the dehumidifier away from a clothes dryer.
7. Use the dehumidifier in a basement to help prevent moisture damage.
8. The dehumidifier must be operated in an enclosed area to be most effective, close all doors, windows and other outside openings to the room.
9. Do not block the air inlet or outlet of the appliance. Reduced air flow will result in poor performance and could damage the unit.

Product Structure

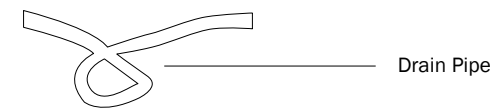
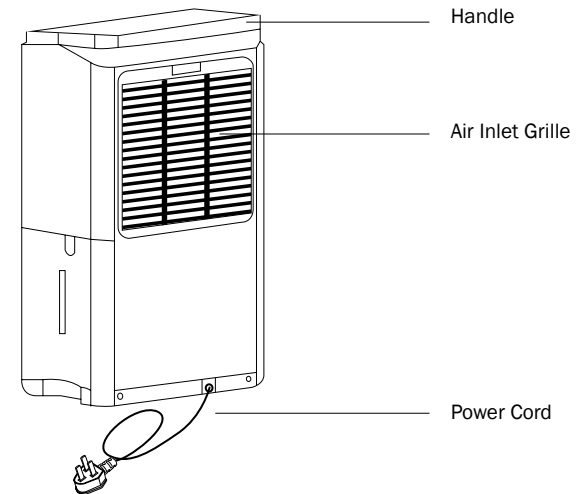
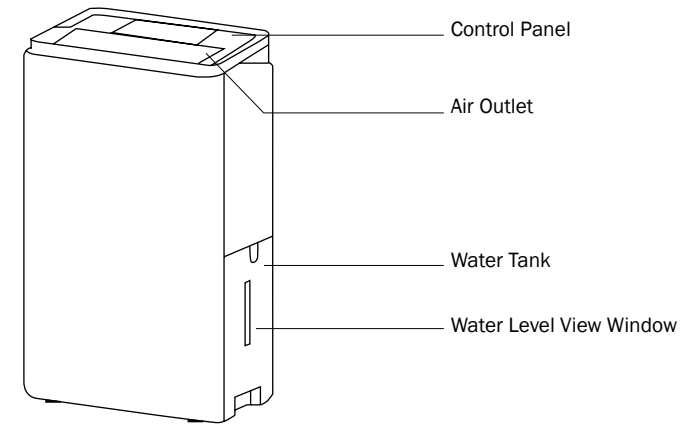

Operating Instructions

Control Panel

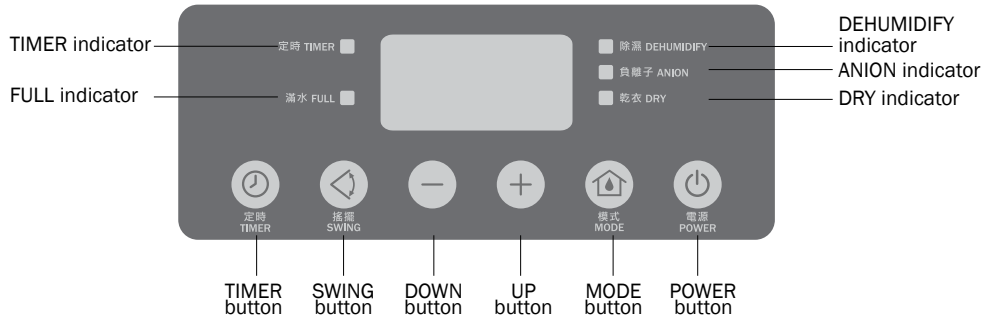

Icons		Function
	POWER	Press POWER to turn the product on and off.
	MODE	When product is on, press MODE to choose among different modes.
	UP/DOWN	When operating in DEHUMIDIFY mode or TIMER function, press UP or DOWN to select desired humidity level or set the timer.
	SWING	When product is on, press SWING to turn Swing function on or off.
	TIMER	Press TIMER to set, check and cancel timer.

Operating Instructions

Before Initial Use

Remove all accessories from the packing and water tank:

1. Remove the water tank from the product.
2. Take out the plug and other accessories.
3. Correctly reinsert the water tank into the product.

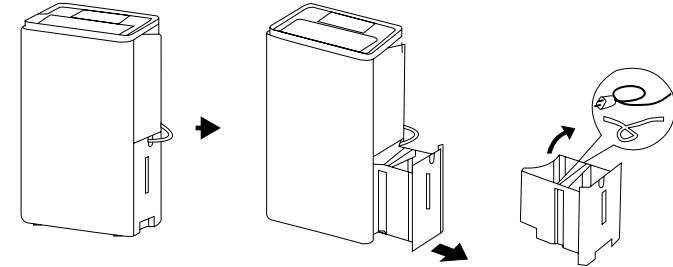

Note:

During operation, warm air exhausting from the top of the unit is a normal phenomenon. It is not a malfunction.

Dehumidify Mode

When the product is turned on, press until DRY Indicator lights up. Then press or to select humidity level between 35%RH - 80%RH. Display Panel will show the setting humidity for 3 seconds, then panel will display the ambient humidity. When ambient humidity is lower than set humidity, compressor will stop running, and fan will continue to run.

Continuous Dehumidify Mode

In Dehumidify Mode, press until Display Panel shows "□□", after which the product will run continuously until it is manually turned off.

Anion Mode

When the product is turned on, press until ANION Indicator lights up. The screen display below:

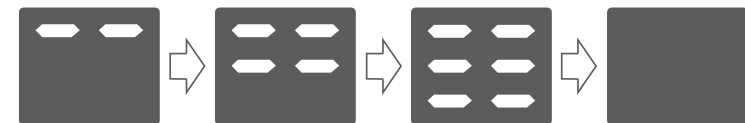

Note:

In Anion Mode, the compressor does not run, and Dehumidify function is inactivated.

Operating Instructions

Dry Mode

This mode is for drying laundry. When the product is turned on, press  until DRY Indicator lights up, Display Panel shows ambient humidity, humidity level cannot be adjusted. After product has continuously run in Dry Mode for 24 hours, it will automatically return to Dehumidify Mode at default humidity of 60%RH.





Note:





- Dry Mode facilitates the drying of laundry by lowering ambient humidity level, not direct drying laundry with dry heat.
- At all times, DO NOT cover the product's air outlet, and DO NOT hang wet laundry on top of the product to avoid water dripping into and damaging the product.
- When drying laundry, please close all windows and doors to facilitate the drying process.

Dehumidifying + Anion Mode

Press  until DEHUMIDIFY and ANION Indicators both light up. The product runs in the principle of Dehumidifying mode but together with Anion function.

Timer Function

Countdown To Switch On: When the product is in standby status, press  and set time from 0.5-24 hours by pressing  or . After 5 seconds, Timer will start to countdown; once the set time arrives, the product will turn on automatically. To cancel Timer, press  again.

Countdown To Switch Off: While the product is running, press . and set time from 0.5-24 hours by pressing  or . After 5 seconds, Timer will start to countdown; once the set time arrives, the product will turn off automatically. To cancel Timer, press  again.

Automatic Defrost

Should frost build up on the evaporator coils, the compressor will stop running and the fan will continue to run until the frost disappears. When the coils are completely defrosted, the compressor will automatically restart and dehumidifying will resume.

Operating Instructions

Water Tank Full Alert

When the water tank is full, the compressor and fan will automatically turn off, TANK FULL indicator will flash. 3 minutes later, the buzzer will beep; 6 minutes later, buzzer will beep again to remind user to empty the water tank. 5 seconds after the water tank has been emptied and properly reinstalled, TANK FULL indicator will stop flashing and product will restart.

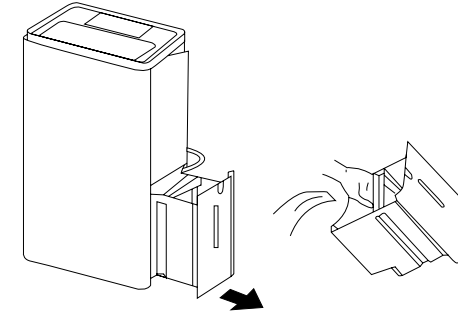

Take out the water tank, empty the water and reinsert properly into the product.

Note:

Do not place the water tank on the floor when it is full as it is uneven on the bottom and water may spill.

Operating Instructions

Continuous Drainage

To avoid frequent emptying of the water tank, user may attach the enclosed drain pipe onto the water drainage nozzle of the product, then water can run continuously without having to empty the water tank.

1. Put the unit on a levelled floor, and remove the water tank.
2. Install the pipe onto the drain nozzle.
3. Reinsert the water tank properly, and make sure the drain pipe sits on the gap of the water tank without being pressed.
4. Press  to turn on the product.
5. If continuous drainage is no longer needed, please remove the drain pipe and reinsert the water tank properly, then water will flow back into the tank.

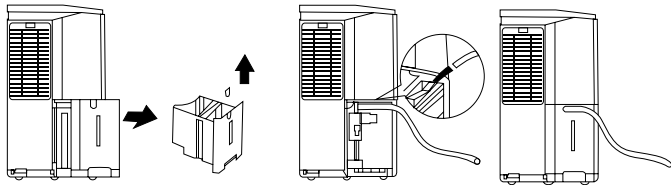

Note:

Attach the drain pipe according to the diagram below. Note that if drain pipe is not installed properly, water cannot drain from the pipe.

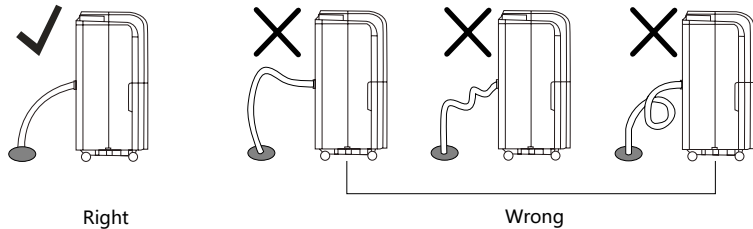

Note:

If the product is placed on an un-level surface, or drain pipe is not installed correctly, water will fill into the water tank and product will stop running. Please make sure the ground surface is horizontal and level, the drain pipe is correctly installed, and that the water tank has been reinserted properly.

Cleaning & Maintenance

⚠ WARNING!

Before cleaning or maintenance, turn the product off, wait for a few minutes then unplug from the power source. DO NOT spray water directly onto the product to avoid electric shock or damaging the product structure.

Cleaning The Main Body

- Clean the exterior with a slightly damp cloth then wipe dry with dry cloth.
- DO NOT use petrol, alcohol or solvents to clean the product.
- DO NOT spray insecticide or similar liquids on the product to avoid damaging the coating or causing deformation to the plastic parts.

Cleaning The Filter

A dirty filter will affect air circulation and dehumidifying capacity of the product. Anion purifying efficiency will also be affected. If product is used consistently or for prolonged periods of time, please clean the filter every week in order to keep the product working efficiently,

Note:

To avoid deformation of the filter, let it air dry completely after cleaning. DO NOT use petrol, alcohol or solvents to clean the filter.

- When taking out the filter, please first pull off the air grille, then take out the filter.
- Simply remove the dust with a vacuum cleaner.

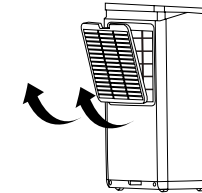

⚠ WARNING!



To avoid possible cuts, avoid contact with the metal parts of the appliance when removing or re-installing the filter. It can result in the risk of personal injury.

Storage Instructions

- If product will not be used for a prolonged period of time, please unplug from the power source.
- Clean the product and let it completely air dry. After product and water tank are completely dry, put the power cord back into the water tank, then cover the product with plastic bag or dust bag to prevent dust from entering.
- When taking the product out of storage, make sure the power cable and plug are undamaged and the earth system is efficient. Follow the installation instructions precisely.

Troubleshooting

Occasionally, you may encounter some problems that are of a minor nature and a service call may not be necessary. Use this troubleshooting guide to identify possible problems you may be experiencing:

Problem	Possible Cause	Solution
Dehumidifier does not start	The dehumidifier is unplugged	Make sure the dehumidifier's plug is inserted completely into the power socket
	The fuse is blown/circuit breaker is tripped	Check the house fuse/circuit breaker box and replace fuse or reset breaker
	Dehumidifier has reached its present humidity setting, or the water tank is full	Change to a lower setting Empty and reinsert the water tank properly
	Water tank is not properly installed	Water tank must be in place and securely seated for the product to operate
	Power failure	There is a protective time delay (approx. 3 min.) to prevent tripping of the compressor overload. For this reason, the product may not restart for 3 min after it is powered back on
Dehumidifier does not dry the air as it should	Not enough time allowed for product to remove moisture	When first installed, allow at least 24 hours to maintain the desired humidity level
	Airflow is restricted	Make sure there are no curtains, blinds, or furniture blocking the front or back of the product. See "Location Requirements" section
	Dirty filter	See "Cleaning The Filter" section
	The humidity setting may not be set low enough	If ambient humidity is low, press  to lower the humidity desired in the room, or set the dehumidifier to  for dehumidifying at maximum level
	Doors and windows may not be closed tightly	Check that all doors, windows, and other openings are securely closed
	Clothes dryer may be blowing moist air into the room	Install the dehumidifier away from the clothes dryer
	Room temperature is too low	Raise the room temperature
Appliance runs too long	The area is too large	The capacity of the appliance cannot meet the area of the room
	Doors and windows are open	Close the door and windows
Frost appears on heat-exchanger	Appliance has been turned on recently, or the room temperature is too low	This is a normal phenomenon, and the frost will usually disappear in 60 min.
Fan noise	The air is passing through the appliance	This is a normal phenomenon
Water on the floor	The drain pipe may be aging	Check that the drain pipe is installed securely and that there is no leakage
	The drain pipe is connected, but no water is drained out	Check that the drain pipe is installed securely, and make sure there are no kinks in the pipe

Troubleshooting

If the following error code appears, contact Customer Service & Repair Centre for inspection and repair.

CODE	DESCRIPTION
EH	Humidity sensor failure
E1	Temperature sensor failure
E2	

Product Specification

Model	DHM-914
Voltage/Frequency	220-240V/50Hz
Power Input (26.7 °C, RH60%)	250W
Rated Power Input (EN60335)	300W
Rated Dehumidification Capacity (26.7 °C, RH60%)	14L
Rated Dehumidification Capacity (30 °C, RH80%)	25L
Applicable Room Temperature	5 °C-32 °C
Capacity: Water Storage	4.2L
Product Dimensions	(H) 570mm (W) 360mm (D) 200mm
Packing Dimensions	(H) 615mm (W) 390mm (D) 235mm
Net Weight	14.3kg
Gross Weight with Packing	15.5kg

Specification is subject to change without prior notice.

If there is any inconsistency or ambiguity between the English version and the Chinese version, the Chinese version shall prevail.

Refer to www.germanpool.com for the most up-to-date version of the User Manual.

警告及注意事項	17
產品結構	19
操作說明	20
清潔與保養	24
常見故障	25
技術規格	26
保用條款	27

請按照此使用說明指南所描述來使用本產品。

1. 禁止兒童或無自理能力的人在無人監管時使用本產品。
2. 本產品設計用於家庭室內使用，不可用作其它用途。
3. 如果電源線損壞，必須由生產商、服務代理商或有同等資格的機構提供更換，避免危險發生。
4. 任何的更改或替換本產品特性的行為都是非常危險的。
5. 如果本產品需要維修，請聯繫生產商授權的技術服務中心，使用原裝的配件；由非授權的個人維修都很危險，並且保修無效。
6. 本產品不主張讓小孩或體弱者在沒有他人監護的情況下使用。
7. 必須監督小孩以保證他們不會玩耍本產品。
8. 本產品必須有接地安裝，必須經具有電工資格的技術人員來檢驗內部的電路。
9. 不要在室外使用本產品。
10. 切不可堵塞出風口和進風口。
11. 不得使用任何外延電纜線。
12. 在清潔或者維護本產品之前，請將電源插頭拔出。
13. 不要拉動電纜線來移動本產品。
14. 請不要將本產品安裝在有天然氣、汽油以及硫磺的房間內，切不可靠近熱源安裝。
15. 不要在斜坡地面上使用本產品。
16. 請務必與易燃物（如酒精）或者耐用容器（如氣霧劑罐）保持至少50cm的距離。
17. 切勿將重物或者發熱物體放置在機器頂端。
18. 定期清潔過濾網。
19. 在運輸本產品過程中，請保持垂直並靠一邊放置，移動本產品前請務必先倒空水箱裡的水，在運輸完後，如需啟動，請稍候半小時。
20. R134a / R410A是一種遵從相關環境標準的製冷劑，電器中製冷劑的迴圈都是封閉的，在使用壽命結束以後，請將電器交於專門的回收中心。
21. 包裝物是可回收的，因此推薦你將它們放置於對應的廢品分類回收箱。
22. 本產品的安裝必須跟相關法規相一致。
23. 保險管的型號規格為：3. 15A 250V

電源連接

如搬動過本產品，請在半小時後再重新啟動。在將本產品的電線插頭插入電源插座前，請檢查：

1. 主供電源制式符合本產品銘牌上標識的電源要求。
2. 電源插座和電路適用於本產品。
3. 電源插座與插頭要相匹配，請通過合格的電工更換一個相匹配的電源插頭。
4. 電源插座一定要有接地設置。
5. 電器電纜必須經由被核准的服務人員更換。

警告及注意事項

位置要求

本產品禁止在狹小密閉的空間中使用，比如衣櫥裡。如果在這種狹小的空間中使用，請將衣櫥的門打開一定角度，使內外空氣流通。

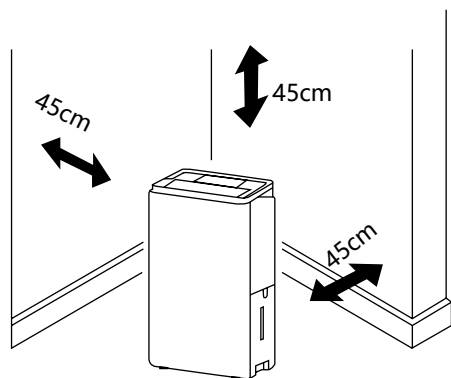

1. 不能在室外使用。
2. 本產品只限於在室內使用。請把本產品放置在光滑、平整且足夠支撐滿滿一桶水的地板表面。
3. 本產品擺放位置各方向至少有45cm空間讓空氣流通。
4. 請把本產品放置在溫度不低於5°C的地方。
5. 在廚房、洗衣區、沐浴房、洗碗區裡使用本產品時會抽得更多的水分。
6. 請讓本產品遠離衣物烘乾機。
7. 在地下室使用本產品，有助於防止潮濕損壞物品。
8. 本產品在一個封閉的區域使用，效果更明顯更有效。
9. 不要堵塞機器進、出風口，保持其通風順暢，否則可能減少機器的性能並且對機器有損害。

產品結構

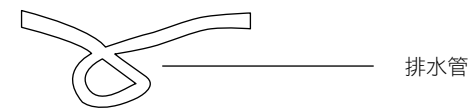
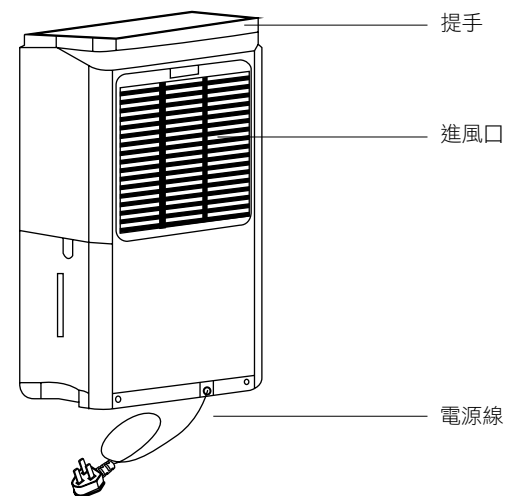
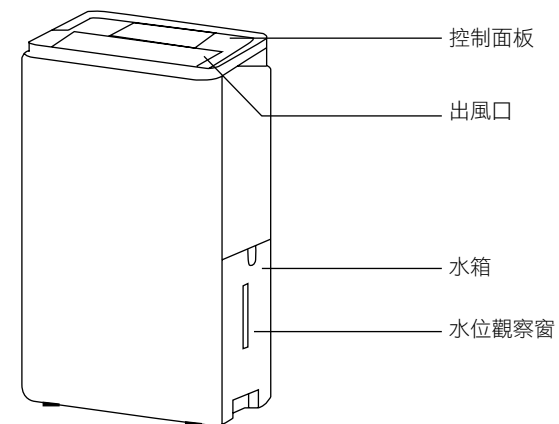

操作說明

控制面板

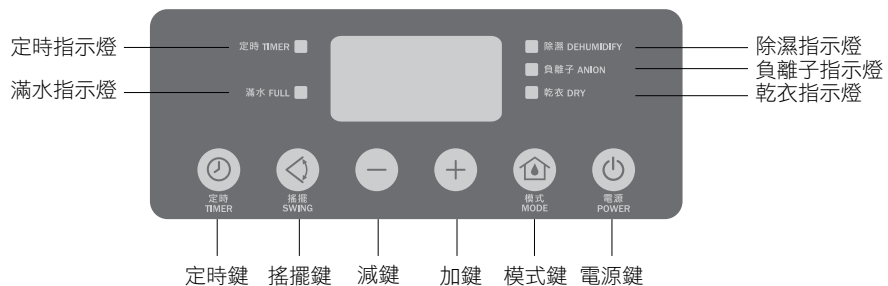

按鍵		功能
	電源	按電源鍵啟動或關閉本產品。
	模式	開機後按下模式鍵，可選擇不同模式。
	加/減	使用除濕模式或定時功能時，按加鍵及減鍵設定濕度或定時時間。
	搖擺	在本產品運行時按搖擺鍵，可啟用或停用搖擺功能。
	定時	按定時鍵設定定時、查詢定時，或取消定時。

操作說明

初次使用

請先從包裝及水箱內取出所有配件：

1. 從機身取出水箱。
2. 取出水箱裡的電源線插頭及排水管。
3. 將水箱正確裝回機身。

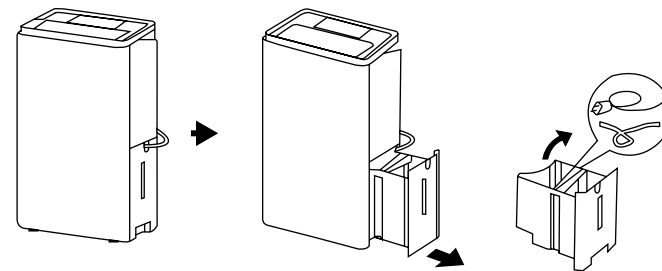

注意：

當抽濕機運行時，會從前方把熱空氣排出，這是正常現象。

除濕模式

開機後，按 模式鍵選擇除濕模式，除濕指示燈亮起，然後按 加 / 減鍵設定濕度，可調節範圍為35%RH - 80%RH，顯示屏顯示設定濕度3秒，然後顯示當前環境濕度。當環境濕度低於設定濕度時，壓縮機不運行，而風扇會持續運行。

連續除濕模式

在除濕模式下，按 減鍵直到顯示屏顯示 ，此時抽濕機會持續運行直至手動關機。

負離子模式

開機後，按 模式鍵選擇負離子模式，負離子指示燈亮起。此時顯示幕顯示如下：

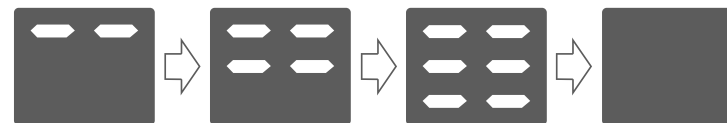

注意：

負離子模式下，壓縮機不開啟，除濕功能不啟動。

操作說明

乾衣模式

開機後，按  模式鍵選擇乾衣模式，乾衣指示燈亮起，顯示幕顯示環境濕度，濕度不可調節。抽濕機運行24小時後，自動退出乾衣模式，轉為除濕模式，預定濕度為60%RH。





注意：





- 乾衣功能以抽走空氣水份令衣物快乾，而非直接加熱烘乾衣物。
- 嚴禁以衣服或任何物品遮蓋抽濕機出風口，嚴禁將滴水的衣物晾掛在抽濕機上方，以免抽濕機入水損壞零件。
- 乾衣時應關上門窗，以製造密閉空間進行抽濕。

除濕+負離子模式

開機後，按  模式鍵選擇除濕模+負離子模式，抽濕指示燈及負離子指示燈同時亮起，其運行原理與除濕模式相同，並同時啟用負離子功能。

定時功能

定時開機：在產品待機狀態下，按  定時鍵，定時指示燈開始閃爍，再按  /  鍵選擇時間，如在5秒鐘內未進行操作，定時開機功能啟動，此時定時指示燈亮起。再按  定時鍵一次取消定時開機。

定時關機：在產品運行狀態下，按  定時鍵，定時指示燈開始閃爍，再按  /  鍵選擇時間，如在5秒鐘內未進行操作，定時關機功能啟動，此時定時指示燈亮起。再按  定時鍵一次取消定時關機。

自動除霜功能

當環境溫度太低時，會有霜出現在換熱器上，此時壓縮機會停止，但風扇會持續運轉，直到霜溶化。霜溶化後，壓縮機會自動啟動，重新開始抽濕。

排水指引

當水位達到上限，抽濕機會自動停止運作，水滿指示燈閃爍，3分鐘後蜂鳴器響起，提示用戶清空水箱；6分鐘後蜂鳴器再響，再次提示用戶清空水箱。當水箱清空並重新安裝到機內，5秒鐘後水滿指示燈停止閃爍，抽濕機恢復運作。

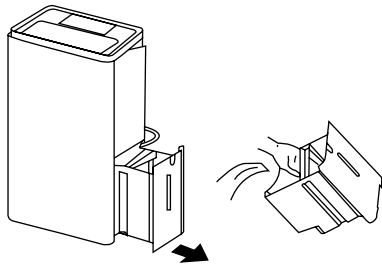

請取出水箱，把水箱內的水清空，再裝回抽濕機內。

操作說明

注意：

當水箱中有水，請不要將水箱放在地板上，因為水箱底部不平，會導致水灑在地板上。

連續排水

如果您不想經常要清倒水箱，可把排水管連接到抽濕機的排水孔上，可讓抽濕機在不用清空水箱的情況下持續運行。

- 把抽濕機放在平穩的地面上，取出水箱。
- 將排水管安裝在抽濕機排水口。
- 將水箱安裝回正確位置，並將水管置於水箱缺口上，不要壓迫水管。
- 按  電源鍵啟動抽濕機。
- 如果不再需要使用連續排水功能，請移除排水管，同時將水箱安裝回正確位置。

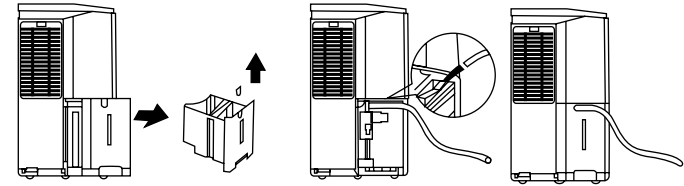

注意：

排水管的放置如下圖所示。請正確放置排水管，否則可能無法將水排出。

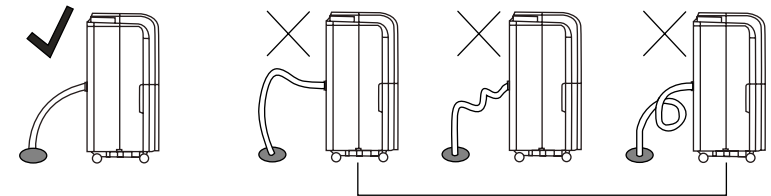

正確

錯誤

注意：

如果抽濕機放置在不平的地面上，或不正確安裝排水管，會導致水灌滿水箱及機器停止運行。如出現此情況，請檢查抽濕機的擺放位置及排水管是否正確安裝。

清潔與保養

⚠ 警告！

在每次進行清潔或維修之前，請把電源插頭拔出，以避免觸電。
切勿用水淋灑機身，以免觸電及損壞產品結構。

機身清潔

- 先使用濕布清潔，再用乾布擦乾。
- 切勿用汽油、酒精或者溶劑來清潔機身。
- 切勿向機身噴灑殺蟲劑或類似物品，以免導致漆面脫落以及塑膠部分彎曲變形。

濾網清潔

如果濾網變髒，將影響空氣的迴圈以及抽濕效率，負離子空氣淨化功能也將降低，因此務必定期清潔濾網。如果本產品經常性使用或者連續地運行，建議每周清潔一次。

注意：

為防止濾網變形，清洗後請先讓其自然風乾，切勿用機器烘乾。
請勿使用酒精、汽油、苯等化學溶劑清洗。

- 取出過濾網時，請先拉出格柵，再取出濾網。
- 用吸塵機吸走表面的灰塵即可。

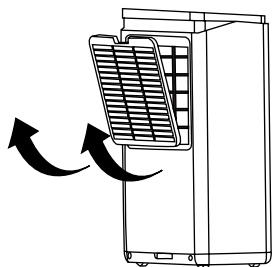

⚠ 警告！

為避免可能的人身傷害，移除或安裝濾網時，切勿觸碰機器內部的金屬部件。

產品收納

- 如果長時間不使用抽濕機，請拔掉電源插頭。
- 收納前應將產品洗淨及讓其風乾，把電源線放回水箱，再用膠袋或塵袋套好產品以免飛塵等污染，直立放置在乾燥的地方，以備下次使用。
- 經長時間存放後，再次使用前，請檢查並確保電源線及插頭沒有破損，接地良好，並重新按上述方法連接電源及操作。

常見故障

問題	可能原因	解決方法
抽濕機不啟動	抽濕機沒有電源	確保抽濕機電源插頭插入插座上
	保險絲斷了，斷路器跳開	檢查房子保險絲/斷路器箱，更換保險絲或復位斷路器
	抽濕機已經達到了設定的濕度或水箱水滿	設置為較低的濕度或清空水箱
	水箱安裝位置不當	水箱必須正確地安裝
	電源故障	有一個保護延遲時間(約3分鐘)來防止壓縮機超載跳開，因為這個原因，在啟動後約3分鐘內抽濕機可能無法啟動壓縮機
抽濕機不抽濕	沒有足夠的時間允許設備來去除水分	第一次使用時，至少必須要運行24小時後來保持所需的乾燥度
	空氣不流通	確保沒有窗簾、百葉窗或傢俱擋在抽濕機的前面或後面，見“位置選擇”章節
	過濾網過髒	見“濾網清潔”章節
	濕度設置可能不夠低	空氣比較乾燥，按“☉”鍵設定室內所需的濕度，或設置到“☐”可達到最大抽濕效能
	門窗可能沒有完全被關閉	把所有門窗和其他的開口關閉
	衣物烘乾機可將潮濕空氣吹進房間	安裝抽濕機時要遠離衣物風乾機
	房間的溫度太低	提高房間溫度
抽濕機運行太久	抽濕機所處的區域太大	抽濕機的抽濕能力不能滿足房間大小
	有門窗打開	關閉門窗
抽濕機上有霜出現	抽濕機最近啟動過或房間溫度太低	這是正常的，霜通常會在60分鐘內消失
風扇有雜訊	空氣正在通過這個設備	這是正常的
水流在地板上	排水管可能老化	檢查排水管及接頭是否有漏水
	排水管已連接，但水排不出	檢查並重新連接排水管，使其平順

常見故障

如果出現以下故障代碼，請聯繫德國寶客戶服務及維修中心進行檢查維修。

故障代碼	故障描述
EH	濕度感測器故障
E1	溫度感測器故障
E2	

技術規格

型號	DHM-914
電壓/頻率	220 - 240V/50Hz
輸入功率 (26.7°C, RH60%)	250W
額定輸入功率 (EN60335)	300W
額定抽濕量 (26.7°C, RH60%)	14L
額定抽濕量 (30°C, RH80%)	25L
適用室溫	5°C - 32°C
水箱容量	4.2L
產品尺寸	(H) 570mm (W) 360mm (D) 200mm
包裝尺寸	(H) 615mm (W) 390mm (D) 235mm
淨重	14.3kg
總重連包裝	15.5kg

產品規格及設計如有變更，恕不另行通知。

中英文版本如有出入，一概以中文版為準。

本產品使用說明書以www.germanpool.com網上版為最新版本。

保用條款

此保用提供德國寶產品之機件在正常使用下壹年保用 (自購買日起計算)。

* 貴戶須在購機十天內，以下列其中一種方式向本公司登記資料，保用手續方正式生效：

1) 填妥本公司網頁內之保用登記表格

www.germanpool.com/warranty

2) 填妥保用登記卡，郵寄至本公司。



Warranty Terms & Conditions

Under normal operations, the product will guarantee a 1-year full warranty provided by German Pool (effective from the date of purchase).

* This warranty is not valid until customer registration information is received by our Service Centre within 10 days of purchase via one of the following means:

1) Visit our website and register online:

www.germanpool.com/warranty

2) Complete all the fields on the attached Warranty Card and mail it back to our Customer Service Centre.



另請填妥以下表格並與正本發票一併保存，以便維修時核對資料。用戶提供之所有資料必須正確無誤，否則免費保用將會無效。 Please fill out the form below. This information and the original purchase invoice will be required for any repairs. Warranty will be invalidated if information provided is found to be inaccurate.

型號 Model No. : DHM-914

機身號碼 Serial No. : _____ 發票號碼 Invoice No. : _____

購買商號 Purchased From : _____ 購買日期 Purchase Date : _____

- 未能出示購買發票正本者，將不獲免費維修服務。
- 用戶應依照說明書的指示操作。本保用並不包括：
 - 上門安裝、檢驗、維修或更換零件之人工以及一切運輸費用；
 - 因天然與人為意外造成的損壞 (包括運輸及其他)；
 - 電源接合不當、不依說明書而錯誤或疏忽使用本機所引致之損壞。
- 於下列情況下，用戶之保用資格將被取消：
 - 購買發票有任何非認可之刪改；
 - 產品被用作商業或工業用途；
 - 產品經非認可之技術人員改裝或加裝任何配件；
 - 機身編號被擅自塗改、破壞或刪除。
- 總代理有權選擇維修或更換配件或其損壞部份。
- 產品一經被轉讓，其保用即被視作無效。

- Customer who fails to present original purchase invoice will not be eligible for free warranty service.
- Customer should always follow the operating instructions. This warranty does not apply to:
 - labour costs for on-site installation, check-up, repair, replacement of parts and other transportation costs;
 - damages caused by accidents of any kind (including material transfer and others);
 - operating failures resulting from applying incorrect voltage, improper usage, and unauthorized installations or repairs.
- This warranty is invalid if:
 - the purchase invoice is modified by an unauthorized party;
 - the product is used for any commercial or industrial purposes;
 - the product is repaired or modified by unauthorized personnel, or unauthorized parts are installed;
 - the serial number is modified, damaged or removed from the product.
- German Pool will, at its discretion, repair or replace any defective part.
- This warranty will be void if there is any transfer of ownership from the original purchaser.

客戶服務及維修中心

香港

九龍大業街59號

三湘九龍灣貨運中心地下B室

電話：+852 2333 6249

傳真：+852 2356 9798

電郵：repairs@germanpool.com

澳門

澳門俾利喇街145號

寶豐工業大廈3樓

電話：+853 2875 2699

傳真：+853 2875 2661

Customer Service & Repair Centre

Hong Kong

Unit B, G/F, Sunshine Kowloon Bay Cargo Centre, 59 Tai Yip Street, Kowloon, Hong Kong

Tel : +852 2333 6249

Fax : +852 2356 9798

Email : repairs@germanpool.com

Macau

3/F, Edificio Industrial Pou Fung, 145 Rua de Francisco Xavier Pereira, Macau

Tel : +853 2875 2699

Fax : +853 2875 2661

此保用只適用於香港及澳門

This warranty is valid only in Hong Kong and Macau

German Pool (Hong Kong) Limited

Hong Kong

Room 113, Newport Centre Phase II, 116 Ma Tau
Kok Road, Tokwawan, Kowloon, Hong Kong.
Tel: +852 2773 2888
Fax: +852 2765 8215

China

8th, Xinxiang Road, Wusha Industrial Park,
Daliang, Shunde, Foshan, Guangdong
Tel: +86 757 2980 8308
Fax: +86 757 2980 8318

Macau

3/F, Edificio Industrial Pou Fung,
145 Rua de Francisco Xavier Pereira, Macau
Tel: +853 2875 2699
Fax: +853 2875 2661



香港《S MARK》
安全認證



中國標榜/家電行業
十大影響力品牌

CEO

CEO非凡品牌大賞



香港優質商標



香港工商業獎



2007
最具潛質
創星品牌企業獎



香港中小企業
最佳結構大獎



香港消費者推祟品牌



香港《O獎》
優質服務證書



香港名牌十年成就獎
HONG KONG TOP BRAND TEN YEAR
ACHIEVEMENT AWARD

© All rights reserved. Copying, reproducing or using the contents of this manual is not allowed without prior authorization from German Pool, violators will be prosecuted.