

GERMAN
POOL  德國寶

專業高速健康食品處理器
Professional High-Speed Food Processor

PRO-15

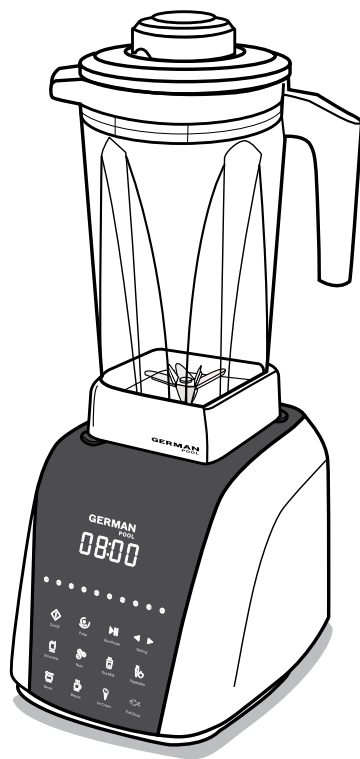

即時網上登記保用
Online Warranty Registration



在使用之前請詳細閱讀「使用說明書」及「保用條款」，並妥為保存。

Please read these instructions and warranty information carefully before use and keep them handy for future reference.

使用說明書 USER MANUAL

Table of Contents

Important Safeguards 03

Product Structure 04

Operation Instructions 06

Lid, Measuring Cup, Seal Ring 08

Cleaning & Storage 08

Notice for Operation 09

Technical Specifications 10

Product Disposal 10

Warranty Terms & Conditions 19

Important Safeguards

Important

- For safety purpose, you should read the instructions carefully before using the appliance for the first time. Save the instructions for future reference.
- The appliance is designed for domestic use and may only be installed and operated in accordance with this instruction manual.
- Do not run the appliance without loading. It is strictly forbidden to operate this appliance without the presence of any liquids, solids or semi-solids inside the blending jar.

1. Before plugging in the appliance, check that the electrical rating shown on the rating plate corresponds with your household electricity supply.
2. Never immerse the unit base (including the base of the blending jar) of the appliance in water or other liquids, nor rinse it under the tap, to avoid risk of short-circuit or electric shock. If there is water inside the unit base, please contact an authorised service agent.
3. Never put the power cord or plug into water for cleaning. Do not wipe the plug prongs with damp cloth, nor plug in with wet hands.
4. Plug the appliance to the wall outlet properly and securely. A loose plug may lead to overheating or electric shock.
5. If the power cord is damaged, it must be replaced by the manufacturer or its service agents or qualified electricians in order to avoid any hazards.
6. Don't leave the appliance unattended when it is in operation.
7. Keep hands and utensils out of the container while the motor is running to prevent personal injuries and/or damages to the appliance.
8. Do not run the appliance without adding water into the blender jar.
9. To avoid spillage, do not allow liquid in the blender jar to exceed the MAX line.
10. For sufficient ventilation, do not expose the appliance to heat sources such as radiators or sunshine, and do not place cloths underneath the appliance.
11. Domestic and indoor use only. Do not use outdoor or for commercial purposes.
12. Always operate with the lid in place. When processing hot beverages, secure the lid properly, and begin processing at a low speed to avoid spilling and potential personal harm.
13. This appliance can be used by persons with reduced physical, sensory or mental capabilities or lack of experience and knowledge if they have been given supervision or instruction concerning use of the appliance in a safe way and if they understand the hazards involved.
14. This appliance shall not be used by children. Keep the appliance and its cord out of reach of children. Children shall not play with the appliance.
15. Turn off and unplug the appliance before changing accessories or touching movable parts.
16. The blades are very sharp, take extra care when emptying the jar and during cleaning. Do not attempt to remove the blades or any moving parts.
17. When the motor overheats, the temperature monitoring system will trigger and stop the motor. Switch off the appliance and let the motor cool down. The motor temperature monitoring system resets after the blender is unplugged from wall socket for 45 minutes. Afterwards, the blender can be used again.
18. All servicing should be performed by an authorised service representative. Do not attempt to disassemble, repair or modify the appliance on your own.
19. Under no circumstances should the blending jar be immersed in any liquids. Do not spray any liquids on the blending jar base. Do not directly rinse the blending jar base under the tap. The blending jar is not dishwasher compatible. If the blending jar base is sprayed or splashed wet, dry immediately.

Product Structure

Unit Body

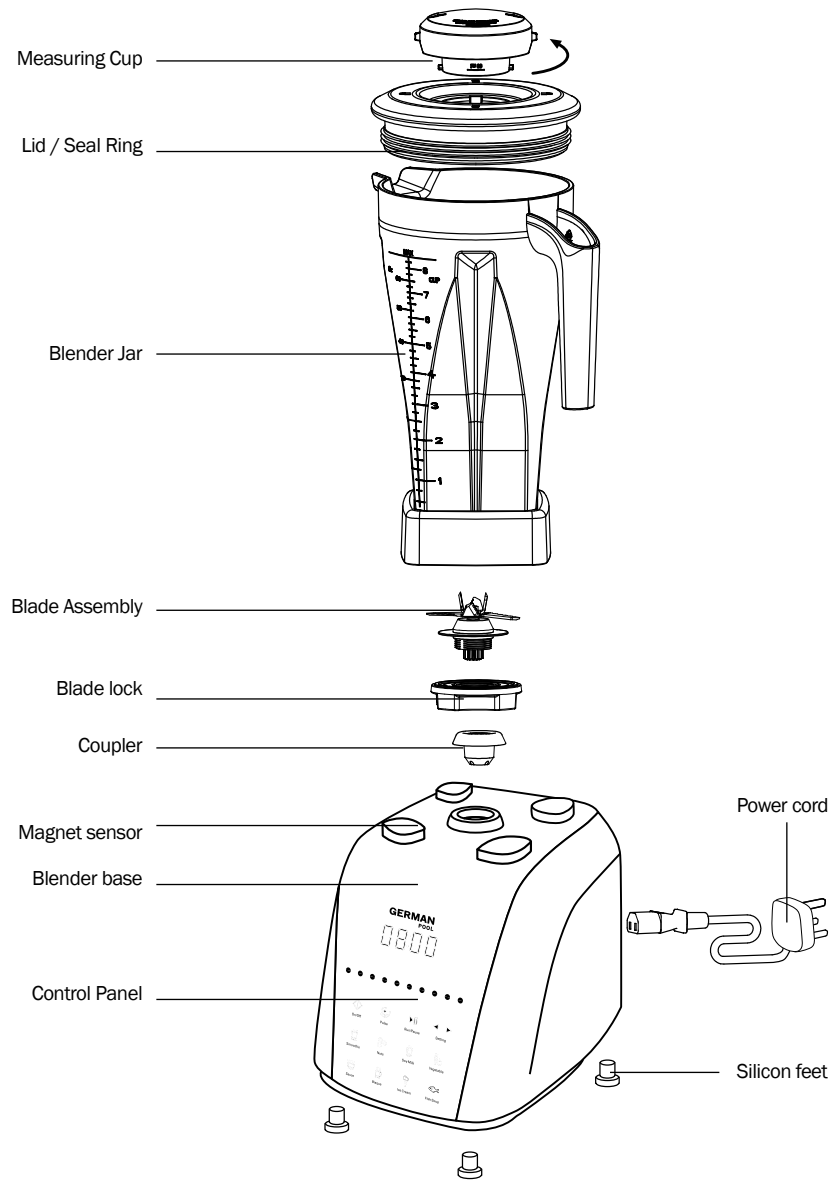

Product Structure

Control Panel

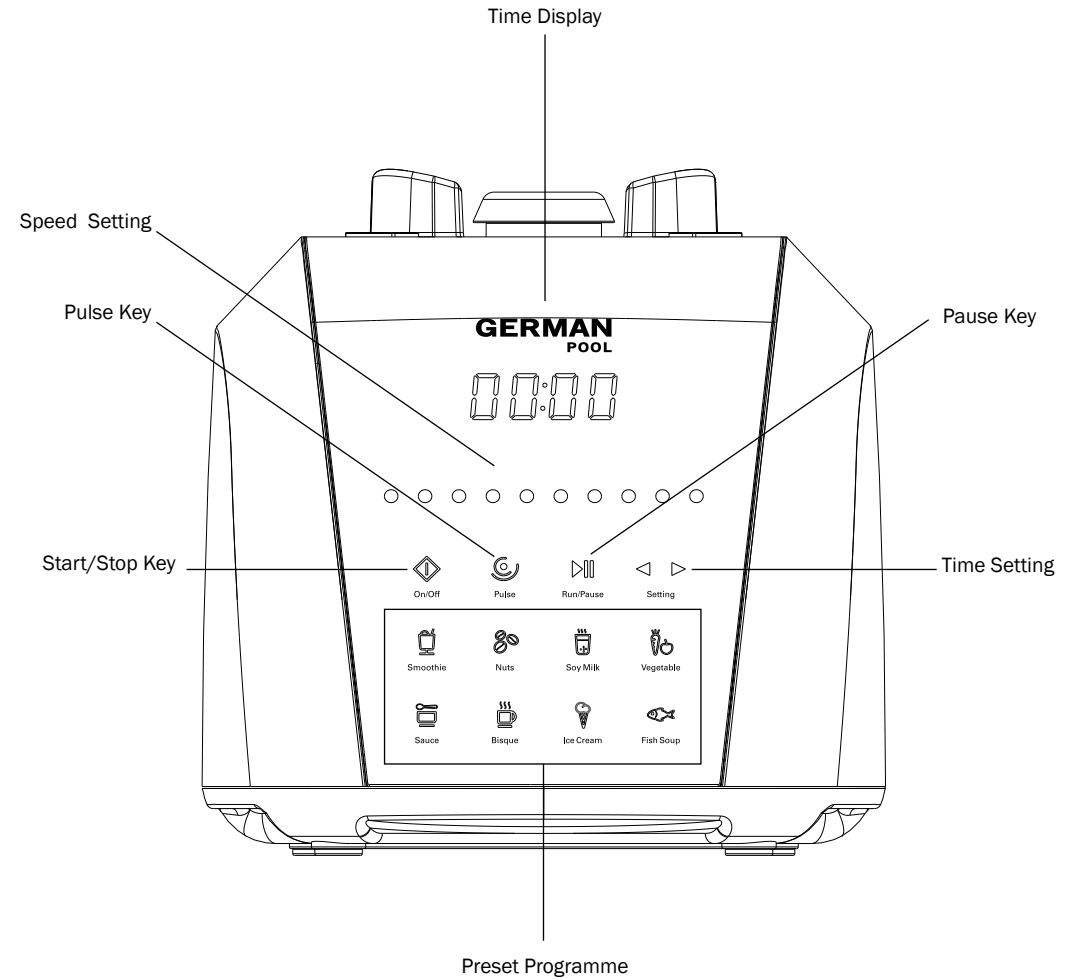











Operation Instructions

Important

- Do not run the appliance without loading. It is strictly forbidden to operate this appliance without the presence of any liquids, solids or semi-solids inside the blending jar.
- Under no circumstances should the blending jar be immersed in any liquids. Do not spray or splash any liquids at the blending jar base. Do not directly rinse the blending jar base under the tap. The blending jar is not suitable for the dishwasher. If the blending jar base is sprayed or splashed wet, dry immediately.
- Under no circumstances should the blending time exceed 1 minute when dry-grinding substances. It is advised to let the appliance rest for 5 minutes before resuming dry-grinding.
- Make sure the electrical rating shown on the rating plate corresponds with your electricity supply. Plug in the unit base to the wall outlet.
- The magnetic sensor (with 4 sensor points on unit body) activates the appliance when the sensor points come into contact.



Pre-set Programme Mode

Press key  product will enter Standby mode, select from the panel , , , , , , ,  any one of the pre-program, then press  key within 30s, the product will run the selected program automatically, after program completed, the product will enter Standby mode automatically.

Manual Speed Mode

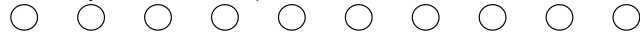

In standby mode, touch the speed slider:



to select desired speed. Press  key within 30s, the product will run the selected speed for maximum 10 minutes. Touch  key to stop the motor at any time, then the product will return to Standby mode.

Note: after setting the speed, time can also be set. Set the desired time, and then press  key within 30s, the product will run the selected speed for the set time. After motor stop the product will return to Standby mode.

Start / Stop key

Start /Stop  key: need to select a pre-program then press  key to activate the product at the corresponding function. When motor is running, press  key to stop the operation, the product will then enter Standby mode.

Pulse Key

 is the Pulse mode. It can only be activated when it is pressed, and it will stop operation when released. The speed of this mode is soft start at full speed(Level H). The key can be used during Stand-by and all other modes. Simply press pulse key to go to level H, when key is released, it will return to Stand-by mode.

Pause Key

 is the Pause key. In any mode of operation, touch it one time the current operation will be paused. Touch it one more time the motor will resume the current operation.









Power Saving Mode

When the product is in Standby mode and kept idle for 3 minutes without any operation, the product will turn to Power Saving mode.

Operation Instructions

Pre-set Programmes

Press set mode icons for programme selection and the selected icon will flash. Press  button within 5 seconds and the appliance will start operation at the selected programme and speed, and enter stand-by mode after completion.

Icon	Function	Operation
	Smoothie	Run at Speed H for 8s and stop for 2s. Repeat the cycle 3 times. Total duration : 30 seconds. 3-second soft-start.
	Nuts	First run at Speed 5 for 5s. Then run under Speed 8 for 2s, stop for 1s, repeat this cycle 10 times. Total duration : 35 seconds. 3-second soft-start.
	Soy Milk	Ramp up to Speed 5 in 5s, and stay on Speed 5 for 25s. Then switch to Speed 8 and run for 30s. Finally increase to Speed H and run until operation ends. Total duration: 6 minutes. 3-second soft-start.
	Vegetable	Follow this sequence: Speed H for 30s, stop for 2s, speed 6 for 10s, stop for 2s, speed H for 60s, stop for 2s, speed 6 for 10s. Total duration: 1 minute 56 seconds. 3-second soft-start.
	Sauce	Run at Speed 8 for 2s and stop for 1s. Repeat the cycle 5 times. Then increase speed to Speed H and run for 45s. Total duration: 1 minute. 3-second soft-start.
	Bisque	Accelerate to Speed 7 within 5s. Then speed up to Speed H within the next 5-10s, and maintain this speed till operation ends. Total duration: 8 minutes. 3-second soft-start.
	Ice Cream	Speed H for 20s, stop for 2s, Speed 6 for 7s, stop for 2s, Speed H for 30s, stop for 2s, Speed 6 for 7s. Total duration : 1 minute 10 seconds. 3-second soft-start.
	Fish Soup	Speed 8 for 5s, stop for 2s (Repeat the cycle 5times); Speed 6 for 15s, stop for 2s; Speed 8 for 20s, stop for 2s; Speed H for 8min; Total duration: 9minutes 14 seconds.

Lid, Measuring Cup, Seal Ring

- Insert the measuring cup into the lid (align the two tabs to grooves of the lid and turn counter-clockwise). Then put the lid on the blender jar by simply pushing down. To open, simply pull up the lid.
- The seal ring is detachable. It can be removed from the lid and be washed separately, cleaning off any residues stuck in between.

Cleaning & Storage

- Make sure the appliance is unplugged from electricity supply.
- Do not immerse the unit base or power cord into water or other liquids.
- Clean surface of the blender jar with soft cloth or sponge. The measuring cup and seal ring can be disassembled for cleaning.
- The blender jar can be rinsed with water. It can also be cleaned by filling it with 2 cups of water, put on the lid and then press the Pulse Key. Pour out the water and dry using a soft cloth.
- After cleaning, put the blender jar on the side or upside down to dry. Do not immerse the whole jar in water.
- Clean the unit base with soft cloth. NEVER immerse it in water or other liquids.
- Caution: If the blender jar is in an upside down position, do not leave it close to the sink or basin to avoid water spraying onto the bottom part of the jar. This may cause rusting of the bearing and hence affecting the performance of the blender.

A Friendly Reminder : To effectively remove dirt on the jar and blades and help them last longer, do the following: add in water and lemon, close the lid and then press "Pulse" button for 2 to 3 times. Replace liquid with clean water and repeat the above step.

3 Easy Steps to Wash the Blender Jar

Caution: Do not immerse the blender jar into water

1. Add 1-2 slices of lemon into 750ml water. Select the "Vegetable" Programme (1min56sec).
2. Pour out water. Repeat Step 1.
3. Pour out water, and wipe it dry with a clean cloth. Put the jar sideways and leave it alone to dry naturally.

Notice for Operation

- For safety reason, the appliance cannot be turned on until the blender jar is placed on the unit base.
- If the motor is operating at a slow speed for a prolonged period, the food is too thick, or there is not enough liquid, the motor can become overheated and the temperature monitoring system will be triggered to stop operation. In this case, switch off and unplug the appliance, let the unit base cool off for 45 minutes, place it at a location with good ventilation, or use a fan to lower its temperature. The system will reset and the blender can be used again.
- During operation, close the lid tightly to avoid contents from spraying, and potential hazards.
- Keep hands and utensils out of the blender jar while the motor is running to prevent the possibility of severe personal injuries and/or damages.
- When making hot beverages such as soybean milk, and bisque etc, please check whether the lid is secured tightly to prevent it from coming off. It is advisable to start operation at a low speed setting and then increase the speed gradually, or use the Pulse mode.
- Always put liquids and soft textured foods into the blender jar first before adding hard textured foods or ice cubes.
- When operation finishes, please wait until the blade assembly comes to a complete stop before taking off the blender jar to avoid damage to the motor.
- If there is a scorching smell coming from the blender, stop operation immediately. It may be caused by the abrasion of an unlevelled cushion base or overheating due to too much content in the jar.
- When making sauces (e.g. almond sauce, jam and sesame sauce) or stuffings and nuts, put in at least 2 cups and no more than 3 cups of ingredients. Keep blending time under 2 minutes to avoid overheating. Too much ingredients may lead to overloading and overheating of the motor. In this case, wait till the motor has cooled down before resuming operation.
- When blending thick and sticky food using high speed, please start operation at low speed first. If blending doesn't begin, disconnect the power and stir the content using a rubber stirrer to get rid of the air bubbles trapped in the food. Then close the lid and resume operation.
- It is recommended not to use the appliance non-stop for 10 minutes.

Technical Specifications

Model No	PRO-15
Voltage / Frequency	220 - 240V ~ 50 - 60Hz
Rated Power	1400W
Dimensions	(H) 506mm (W) 241mm (D) 202mm
Net Weight	4.68 kg

- Specifications are subject to change without prior notice.
- If there is any inconsistency or ambiguity between the English version and the Chinese version, the Chinese version shall prevail.
- Refer to www.germanpool.com for the most up-to-date version of the User Manual.

Product Disposal

Proper Disposal of This Product

This icon indicates that the product should not be disposed with other household wastes throughout the EU. To conserve the environment and prevent endangerment to the public from uncontrolled waste disposal, recycle it responsibly to promote the sustainability and reuse of material resources. To return your used device, please use the return and collection system or contact the retailer where the product was purchased. They will dispose of this product through environmentally safe recycling.

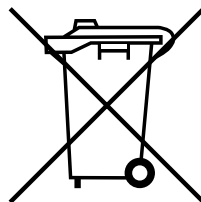

目錄

安全注意事項	12
產品結構	13
操作說明	15
量杯、杯蓋、密封圈	17
清潔保養及維護	17
使用注意事項	18
技術規格	18
環保措施	18
保用條款	19

安全注意事項

重要說明

- 為安全起見，初次使用產品前請先細閱本說明書，並保存說明書，以便作參考之用。
 - 本產品只供家居使用。請必須依照本說明書內的指示安裝及操作。
 - 嚴禁空轉：在果汁杯內未有任何固體、流質食物或液體之情況下，切勿啟動本機。
- 在使用本產品前，確認產品所標明的使用電壓，是否與家用的接地插座電壓一致。
 - 請勿將機體座(包括果汁杯底)泡在水中或對機體座澆水，以免引起短路或觸電，機體座主體內如有浸水，請聯繫售後服務及維修中心。
 - 機體座的電源線和插頭不可用水或其他液體清洗或浸泡，插頭不可用濕布擦拭，手部潮濕時請勿插、拔插頭，以免引起觸電。
 - 本機在使用時，電源插頭務必插到底，不插到底易造成觸電或由於發熱引起火災；請勿使用殘缺或鬆動的插座。
 - 請勿損傷電線及電源插頭；使用受損的電線易引起觸電，短路或火災；如電源線損壞或發生其他故障，切勿自行拆卸本機，必須由製造廠商或其服務處或具有類似資格的专业人員更換和維修。
 - 本機在使用時，切勿無人看管。
 - 果汁杯在主體上時，切勿將手或任何用具、金屬、異物放入果汁杯中，以免受傷或損毀攪拌部份。
 - 切勿將本機在無水情況下進行空轉。
 - 使用本產品時，果汁杯中的水或其他液體不能超過杯子上的最大刻度線。
 - 請勿將本機靠近熱源，請勿在機器下方放置抹布，以免造成散熱不良。
 - 本產品只適用於室內及家居使用，請勿置於室外使用或用作商業用途。
 - 操作時一定要蓋緊杯蓋，裝上量杯，在製作熱飲時請務必蓋好杯蓋，並確定先使用低速運轉，以免高速會噴出熱液體，造成傷害。
 - 本產品不預備給體能弱、反應遲鈍或有精神障礙的人(包括兒童)使用，除非在對其負有安全責任的人員的指導或幫助下安全使用。
 - 兒童應該被監督，請勿讓兒童使用或觸摸本機，以保證他們不玩耍器具。
 - 先關掉電器電源，拔掉電源插頭，然後才可更換配件或碰觸任何運轉的部份。
 - 產品刀片非常鋒利，清空果汁杯和清洗時請務必特別小心，勿自行拆除刀片，請勿觸碰任何在運轉的部份。當不使用機器或拆除或裝設配件或清洗時，請先拔掉插頭。
 - 摩打如超過負荷時，摩打將自動停止運轉，此為摩打內的溫度偵測保護系統啟動，並非摩打故障，用戶需拔掉插頭大約45分鐘後，摩打內的溫度偵測保護系統才能復位，此時便可重新使用。
 - 本產品有任何問題請勿自行拆卸、修理、改造，以免造成自身傷害，欲修理本器具請洽經銷商或售後服務處。
 - 任何情況下，切勿把整個果汁杯浸入任何液體浸泡；禁止向杯底澆水，不能直接沖洗果汁杯底部。果汁杯不適用於洗碗碟機。杯底澆濕後，請立即擦拭乾淨。

產品結構

主機

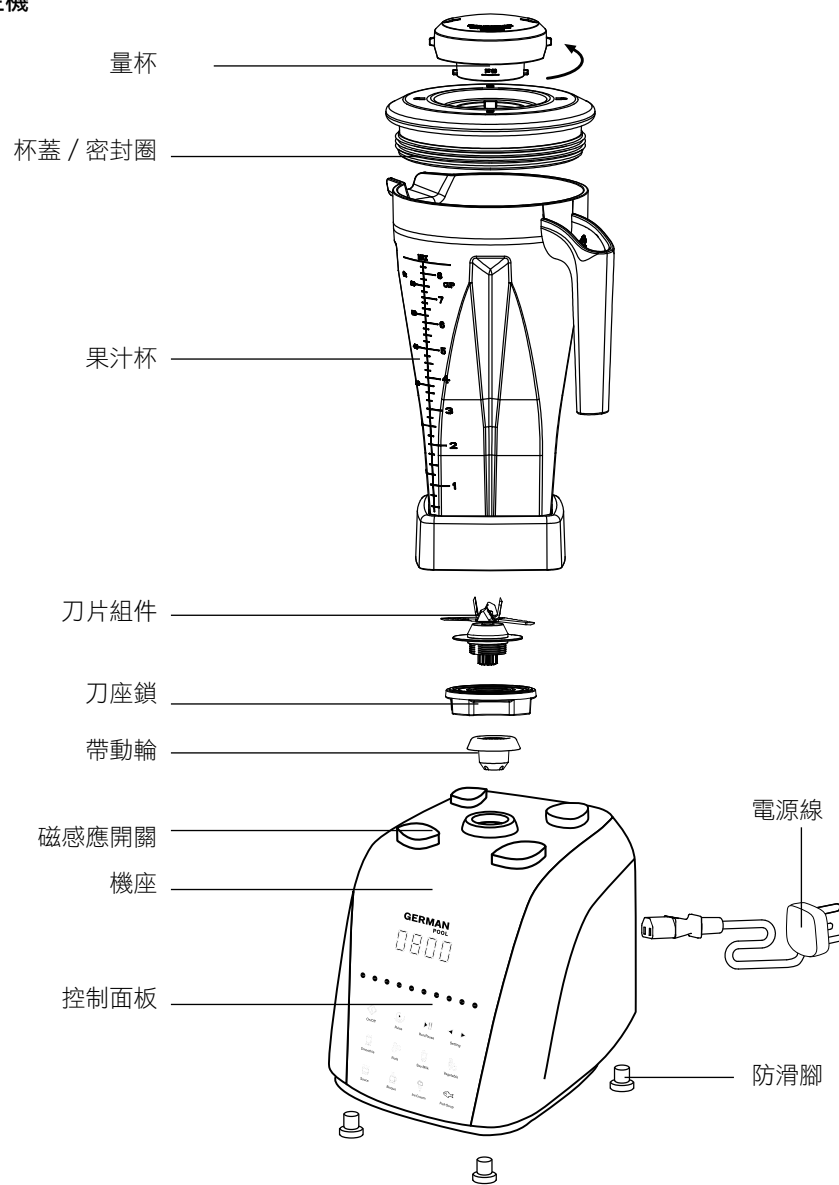

產品結構

控制面板

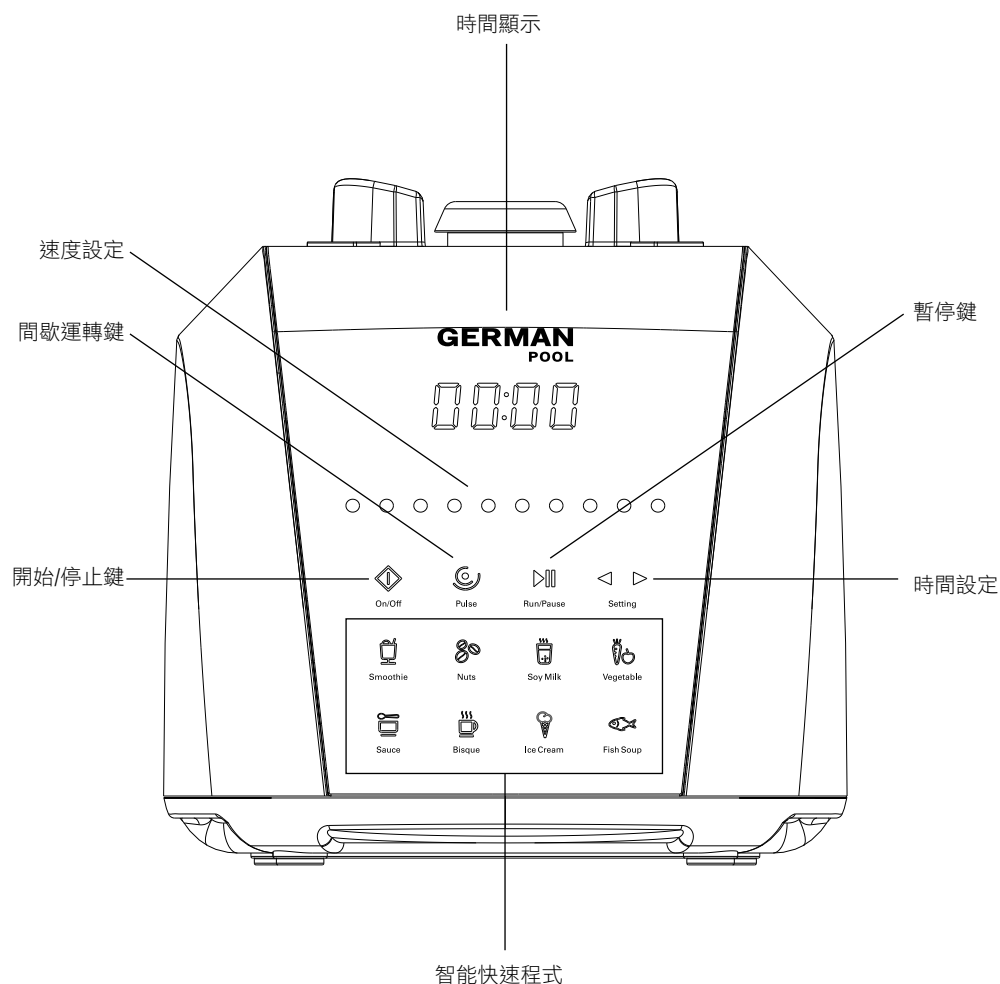











操作說明

重要說明

- 嚴禁空轉：在果汁杯內未有任何固體、流質食物或液體之情況下，切勿啟動本機。
- 任何情況下，切勿把整個果汁杯浸入任何液體泡浸；禁止向杯底澆水，不能直接沖洗果汁杯底部。果汁杯不適用於洗碗碟機。杯底濺濕後，請立即擦拭乾淨。
- 任何情況下，乾磨食材時不能連續操作超過1分鐘。如需連續乾磨，建議讓機件靜置5分鐘再重複操作。

- 先將主機電源插頭插入與主機銘牌標示一致電壓的電源座。
- 磁感應開關（主機內有四個感應點）將讓機器自動感應進入待機模式。



智能快速程式

按  鍵，產品進入待機模式；待機模式下，選擇面板上 、、、、、、、 任意一個快速程式；在30秒內輕觸  鍵，產品才可以運轉相對應的功能，快速程式工作完成後，自動進入待機模式。

手動調速操作



待機模式下，輕觸速度設定滑條：



選擇好速度後，在30秒內輕觸下  鍵，產品運行（上限10分鐘），再次輕觸  鍵，產品停止運作，進入待機模式。

注意：選擇好速度後，也可以再設定時間。根據需要設定好時間，在30秒內輕觸下  鍵，產品運行，運行結束後自動進入待機模式。

開始/停止鍵

先選擇好相應的智能快速程式，再輕觸  鍵，產品以相應的功能運轉；在各種工作模式下，輕觸  鍵，產品停止工作，自動進入待機狀態。

PULSE功能鍵

 PULSE功能鍵為手動點動鍵，必須要按住才能工作，用戶鬆開手後將停止工作，此鍵不受智能快速程式和手動調速模式的工作限制，即：在待機模式或任何工作模式中，只要按住此鍵便立即進入H檔工作，鬆開後產品自動進入待機狀態。

暫停鍵

 為暫停鍵，在任何工作模式下，輕觸一下此鍵，產品處於暫停狀態，再觸一次，產品繼續運行當前模式。

省電模式(上電模式)

產品在待機狀態下，如3分鐘內無任何操作，產品自動進入省電模式。

操作說明

智能快速程式

在待機狀態下，選擇任何智能快速程式，該鍵便會閃動，在5秒內再輕按  鍵，產品便會以所選用的程式運作，程式完成後，產品會自動進入待機模式。

圖示	功能	模式描述
	冰沙	以軟啟動H檔位運轉8秒，停止2秒，以此循環，總運轉時間30秒每次啟動都用軟啟動
	堅果	以5檔運轉5秒；接著以8檔運轉2秒，停止1秒，反覆此動作10次；總運轉時間共35秒 每次啟動都用軟啟動
	豆漿	5秒內加速至5檔，並在5檔位持續運轉25秒；接著加速至8檔並運轉30秒；最後加速至H檔並運轉至結束，共6分鐘 每次啟動都用軟啟動
	蔬果	H檔30秒，停2秒； 6檔10秒，停2秒； H檔60秒，停2秒； 6檔10秒，結束，總運轉時間共1分鐘56秒 每次啟動都用軟啟動
	醬汁	以8檔啟動運轉2秒，接著停止1秒，反覆此動作5次，接著加速至H檔並運轉45秒，總運轉時間共1分鐘 每次啟動都用軟啟動
	濃湯	為5秒內加速至7檔，5-10秒內加速至H檔且固定在最高速，運行8分鐘 每次啟動都用軟啟動
	雪糕	H檔20秒停2秒，6檔7秒停2秒，H檔30秒停2秒，6檔7秒，共1分10秒 每次啟動都用軟啟動
	魚湯	以8檔運轉5秒，停2秒（共循環5次）；然後以6檔運轉15秒，停2秒；8檔運轉20秒，停2秒，最後H檔運轉8分鐘，共9分14秒。

量杯、杯蓋、密封圈

- 將量杯放入杯蓋中(量杯上有兩個小凸點，將凸點對準杯蓋中心口的兩個小凹處，放入後逆時針旋轉即可)再將杯蓋蓋上果汁杯杯口，往下按入即可。再要打開時，只需將杯蓋手柄處往上拉即可。
- 杯蓋密封圈為可拆卸部件，當清洗時可將密封圈取下單獨清洗完後再套上杯蓋。方便徹底清除杯蓋與密封圈上的食物殘渣。

清潔保養及維護

- 拔掉電源插頭才能切斷電源。
- 清潔時用軟布或海綿輕輕擦洗杯子表面，杯蓋上的量杯及密封圈可取出清洗。
- 使用後果汁杯可以用清水沖洗，也可倒入兩杯清水，蓋緊杯蓋，按間歇運作鍵即可啟動清洗，再用軟布擦拭乾淨。
- 杯蓋密封圈為可拆卸部件，清洗時可將密封圈取下單獨清洗，然後再套上杯蓋，方便徹底清除杯蓋與密封圈上的食物殘渣。
- 清洗完畢後請將果汁杯橫放或倒放(注意)，讓其自然涼乾，不要將杯子整個浸泡於水中。
- 機體座請切勿用清水沖洗，並切勿將機座、果汁杯或電源線等置於水中或其他液體中。可用清潔軟布擦拭。
- 注意：如將杯子倒放晾乾，請將杯底之水漬擦拭乾淨，並且遠離洗手盆，以防水滴不慎流到杯底，造成軸承生水鏽，而使果汁杯損壞。

溫馨提示：為更有效清潔果汁杯內及刀片上之污垢，使杯及刀更耐用，可於果汁杯內加入清水及檸檬，然後蓋緊杯蓋，按PULSE“間歇運轉”鍵2至3次，將水倒去，再注入清水重覆之前程序便可。

簡易果汁杯清洗三部曲

注意：切勿將果汁杯浸入水中

- 加入清水750ml，檸檬1-2片，選「蔬果」程式(1分56秒)。
- 倒出污水。重復步驟1。
- 倒出污水，用乾布抹淨。完成後橫放果汁杯自然風乾即可。

使用注意事項

- 為安全起見，若果汁杯仍未放在機座上，本產品不能啟動。
- 低速下長時間攪拌或所打的食物太濃稠，液體太少容易使摩打過熱導致停止運轉，此乃摩打內的溫度偵測保護系統啟動，摩打將停止轉動，此時請拔掉電源插頭，冷卻45分鐘或將其放置通風處或使用風扇使其溫度降低，以達到散熱目的，方可啟動操作，或改以PULSE(間歇運作)鍵操作。
- 產品工作時，務必請將杯蓋與量杯扣緊，如此杯內的食物才不會噴出造成危險。
- 產品工作時，請勿將任何器具，如：湯匙、手、尖硬物體等放入杯內，以免造成傷害或導致刀片因高速運轉遭外力撞擊而斷裂造成危險。
- 製作熱飲如：豆漿、米漿、濃湯等熱飲時，一定要注意杯蓋與量杯是否扣緊，操作時才不會掉落，並且不要一開始就將速度使用在高速段，請由低速漸進到高速段，或改以PULSE(間歇運作)鍵操作。
- 使用時請將液體及較軟的食物先放入，硬的食物或冰塊較後放入。
- 工作完成後，按停止鍵，請務必等產品完全停止運轉後，才可將杯子拿開，否則容易造成傳動輪損壞。
- 機體產生焦熱時請立即停止使用，其造成之因素為杯子橡皮固定墊未完全壓平，而產生摩擦生熱時造成的焦味，或所放的食物超過其負載，使產品過熱所產生的異味。
- 如製作杏仁醬，果醬，芝麻醬等醬類，或含有輕質的醬料，餡料，穀類雜糧時，所使用的量不要低於兩杯(國際標準量杯)或超過三杯的量，打的時間勿超過2分鐘，以免過熱而產生焦味，如放入的太多會導致超過產品負載，如此須等摩打溫度降低後產品才可再次使用。
- 以高速攪拌食物，若食物較濃稠，則先使用低速再調至高速，若還是無法攪拌，請關掉電源，拿下果汁杯用橡皮刀攪拌，直到食物中的氣泡消除後重新開機使用即可。
- 建議每次不要連續使用本產品超過10分鐘。

技術規格

型號	PRO-15
電壓 / 頻率	220 - 240 V ~ 50 - 60 Hz
功率	1400W
機身尺寸	(H) 506mm (W) 241mm (D) 202mm
淨重	4.68 kg

產品規格及設計如有變更，恕不另行通知。
中英文版本如有出入，一概以中文版為準。
本產品使用說明書以 www.germanpool.com 網上版為最新版本。

環保措施

產品的正確處置方法

該標誌標明該產品在歐盟不能以處理家庭垃圾的方法處理該設備。為避免損害自然環境或人體健康，請盡可能回收該產品，以提高資源的可持續利用。退返使用過的設備時，請利用使用及回收系統或者聯繫當時購買產品的銷售商。銷售商能確保廢棄設備的環保回收。

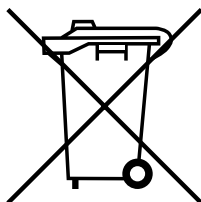

保用條款

此保用提供德國寶產品之機件在正常使用下壹年保用(自購買日起計算)。

- * 貴戶須在購機十天內，以下列其中一種方式向本公司登記資料，保用手續方正式生效：

- 1) 填妥本公司網頁內之保用登記表格
www.germanpool.com/warranty
- 2) 填妥保用登記卡，郵寄至本公司。



另請填妥以下表格並與正本發票一併保存，以便維修時核對資料。用戶提供之所有資料必須正確無誤，否則免費保用將會無效。 Please fill out the form below. This information and the original purchase invoice will be required for any repairs. Warranty will be invalidated if information provided is found to be inaccurate.

型號 Model No. : **PRO-15**

機身號碼 Serial No. : _____ 發票號碼 Invoice No. : _____

購買商號 Purchased From : _____ 購買日期 Purchase Date : _____

1. 未能出示購買發票正本者，將不獲免費維修服務。
2. 用戶應依照說明書的指示操作。本保用並不包括：
 - 上門安裝、檢驗、維修或更換零件之人工以及一切運輸費用；
 - 因天然與人為意外造成的損壞 (包括運輸及其他)；
 - 電源接合不當、不依說明書而錯誤或疏忽使用本機所引致之損壞。
3. 於下列情況下，用戶之保用資格將被取消：
 - 購買發票有任何非認可之刪改；
 - 產品被用作商業或工業用途；
 - 產品經非認可之技術人員改裝或加裝任何配件；
 - 機身編號被擅自塗改、破壞或刪除。
4. 總代理有權選擇維修或更換配件或其損壞部份。
5. 產品一經被轉讓，其保用即被視作無效。

客戶服務及維修中心

中國香港

九龍灣啟興道1-3號

九龍貨倉10樓

電話：+852 2333 6249

傳真：+852 2356 9798

電郵：repairs@germanpool.com

中國澳門

澳門俾利喇街145號

寶豐工業大廈3樓

電話：+853 2875 2699

傳真：+853 2875 2661

Warranty Terms & Conditions

Under normal operations, the product will guarantee a 1-year full warranty provided by German Pool (effective from the date of purchase).

- * This warranty is not valid until customer registration information is received by our Service Centre within 10 days of purchase via one of the following means:

- 1) Visit our website and register online:
www.germanpool.com/warranty
- 2) Complete all the fields on the attached Warranty Card and mail it back to our Customer Service Centre.



1. Customer who fails to present original purchase invoice will not be eligible for free warranty service.
2. Customer should always follow the operating instructions. This warranty does not apply to:
 - labour costs for on-site installation, check-up, repair, replacement of parts and other transportation costs;
 - damages caused by accidents of any kind (including material transfer and others);
 - operating failures resulting from applying incorrect voltage, improper usage, and unauthorized installations or repairs.
3. This warranty is invalid if:
 - the purchase invoice is modified by an unauthorized party;
 - the product is used for any commercial or industrial purposes;
 - the product is repaired or modified by unauthorized personnel, or unauthorized parts are installed;
 - the serial number is modified, damaged or removed from the product.
4. German Pool will, at its discretion, repair or replace any defective part.
5. This warranty will be void if there is any transfer of ownership from the original purchaser.

Customer Service & Repair Centre

Hong Kong, China

10/F, Kowloon Godown

1-3 Kai Hing Road, Kowloon Bay,

Kowloon, Hong Kong

Tel : +852 2333 6249

Fax : +852 2356 9798

Email : repairs@germanpool.com

Macau, China

3/F, Edificio Industrial Pou Fung,

145 Rua de Francisco Xavier Pereira,

Macau

Tel : +853 2875 2699

Fax : +853 2875 2661

此保用只適用於香港及澳門

This warranty is valid only in Hong Kong and Macau

GERMAN
POOL



德國寶

德國寶(香港)有限公司 German Pool (Hong Kong) Limited

中國香港
Hong Kong, China

香港九龍土瓜灣馬頭角道116號
新寶工商中心2期113號室

Room 113, Newport Centre Phase II, 116 Ma Tau
Kok Road, Tokwawan, Kowloon, Hong Kong.

電話 Tel: +852 2773 2888

傳真 Fax: +852 2765 8215

中國內地
Mainland China

廣東省佛山市順德區
大良南國東路德順廣場三層

3/F, Takshun Plaza, Nanguo East Road,
Shunde, Foshan, Guangdong

電話 Tel: +86 757 2980 8308

傳真 Fax: +86 757 2980 8318

中國澳門
Macau, China

澳門俾利喇街145號
寶豐工業大廈3樓

3/F, Edificio Industrial Pou Fung,
145 Rua de Francisco Xavier Pereira, Macau

電話 Tel: +853 2875 2699

傳真 Fax: +853 2875 2661



香港名牌十年成就獎
HONG KONG TOP BRAND TEN YEAR
ACHIEVEMENT AWARD



香港卓越名牌
HONG KONG
PREMIER BRAND



2007
CERTIFICATE AWARDS FOR THE BEST BRAND ENTERPRISE
最佳品牌企業獎



中小企業
最佳拍檔大獎



© 版權所有。未獲德國寶授權，不得翻印、複製或使用本說明書作任何商業用途，違者必究。

© All rights reserved. Copying, reproducing or using the contents of this manual is not allowed without prior authorization from German Pool, violators will be prosecuted.

www.germanpool.com