

## Built-In Induction Cooker | GIC-128DB/GIC-152DB



Online Warranty Registration



Please read these instructions and warranty information carefully before use and keep them handy for future reference.

# USER MANUAL

請即進行保用登記!

有關保用條款細則，請看本說明書最後一頁。

---

Please register your warranty information now!

For Warranty Terms & Conditions,

please refer to the last page of this user manual.

# Table of Contents

---

Warnings and Recommendations	04
Product Structure	07
Installation Instructions	08
Operating Instructions	12
Troubleshooting	16
Technical Specifications	17
Warranty Terms & Conditions	31

# Warnings and Recommendations

---

## Safety Warnings

Thank you for purchasing German Pool Built-in Induction Cooker.

We recommend that you spend some time to read this Instruction / Installation Manual in order to fully understand how to install correctly and operate it.

Your safety is important to us. Please read this information before using your cooktop.

## Installation

### Electrical Shock Hazard

- Disconnect the appliance from the mains electricity supply before carrying out any work or maintenance on it.
- Connection to a good earth wiring system is essential and mandatory.
- Alterations to the domestic wiring system must only be made by a qualified electrician.
- Failure to follow this advice may result in electrical shock or death.

### Cut Hazard

- Take care - panel edges are sharp.
- Failure to use caution could result in injuries or cuts.

## Important Safety Instructions

- Read these instructions carefully before installing or using this appliance.
- No combustible materials or products should be placed on this appliance at any time.
- In order to avoid hazard, this appliance must be installed according to these instructions for installation.
- This appliance is to be properly installed and earthed only by a suitably qualified person.
- This appliance should be connected to a circuit which incorporates an isolating switch providing full disconnection from the power supply.
- Failure to install the appliance correctly could invalidate any warranty or liability claims.

## Operation and Maintenance

### Electrical Shock Hazard

- Do not cook on a broken or cracked cooktop. If the cooktop surface should break or crack, switch the appliance off immediately at the mains power supply (wall switch) and contact a qualified technician.
- Switch the cooktop off at the wall before cleaning or maintenance.
- Failure to follow this advice may result in electrical shock or death.

### Health Hazard

- This appliance complies with electromagnetic safety standards.
- However, persons with cardiac pacemakers or other electrical implants (such as insulin pumps) must consult with their doctor or implant manufacturer before using this appliance to make sure that their implants will not be affected by the electromagnetic field.
- Failure to follow this advice may result in death.

### Hot Surface Hazard

- During use, accessible parts of this appliance will become hot enough to cause burns.
- Do not let your body, clothing or any item other than suitable cookware contact the Induction glass until the surface is cool.

# Warnings and Recommendations

---

- Metallic objects such as knives, forks, spoons and lids should not be placed on the hob surface since they can get hot
- Keep children away.
- Handles of saucepans may be hot to touch. Check saucepan handles do not overhang other cooking zones that are on. Keep handles out of reach of children.
- Failure to follow this advice could result in burns and scalds.

## Cut Hazard

- The razor-sharp blade of the cooktop scraper is exposed when the safety cover is retracted. Use with extreme care and always store safely and out of reach of children.
- Failure to use caution could result in injuries or cuts.

## Important Safety Instructions

- Never leave the appliance unattended when in use. Boilover causes smoking and greasy spillovers that may ignite.
- Never use your appliance as a work or storage surface.
- Never leave any objects or utensils on the appliance.
- Do not place or leave any magnetisable objects (e.g. credit cards, memory cards) or electronic devices (e.g. computers, MP3 players) near the appliance, as they may be affected by its electromagnetic field.
- Never use your appliance for warming or heating the room.
- After use, always turn off the cooking zones and the cooktop as described in this manual (i.e. by using the touch controls). Do not rely on the pan detection feature to turn off the cooking zones when you remove the pans.
- Do not allow children to play with the appliance or sit, stand, or climb on it.
- Do not store items of interest to children in cabinets above the appliance. Children climbing on the cooktop could be seriously injured.
- Do not leave children alone or unattended in the area where the appliance is in use.
- Children or persons with a disability which limits their ability to use the appliance should have a responsible and competent person to instruct them on its usage. The instructor should be convinced that they can use the appliance without causing danger to themselves or their surroundings.
- Do not repair or replace any part of the appliance unless specifically recommended in the manual. All other servicing should be done by a qualified technician.
- Do not use a steam cleaner to clean your cooktop.
- Do not place or drop heavy objects on your cooktop.
- Do not stand on your cooktop.
- Do not use pans with jagged edges or drag pans across the Induction glass surface as this can scratch the glass.
- Do not use scourers or any other harsh abrasive cleaning agents to clean your cooktop, as these can scratch the Induction glass.
- If the supply cord is damaged, it must be replaced by the manufacturer, its service agent or similarly qualified persons in order to avoid a hazard.
- This appliance is intended to be used in household and similar applications such as: staff kitchen areas in shops, offices and other working environments; farm houses; by clients in hotels, motels and other residential type environments; bed and breakfast type environments.

# Warnings and Recommendations

---



## WARNING!

- The appliance and its accessible parts become hot during use.
- Care should be taken to avoid touching any heating elements.
- Children less than 8 years of age shall be kept away unless continuously supervised.
- This appliance can be used by children aged from 8 years and above and persons with reduced physical, sensory or mental capabilities or lack of experience and knowledge if they have been given supervision or instruction concerning use of the appliance in a safe way and understand the hazards involved.
- Children shall not play with the appliance. Cleaning and user maintenance shall not be made by children without supervision.
- Unattended cooking on a hob with fat or oil can be dangerous and may result in fire. NEVER try to extinguish a fire with water, instead switch off the appliance and then cover the flame with a lid or a fire blanket.
- Danger of fire: do not store items on the cooking surfaces.
- If the surface is cracked, switch off the appliance to avoid the possibility of electric shock, for the hob surfaces of glass-ceramic or similar materials which protect live parts
- A steam cleaner is not to be used.
- The appliance is not intended to be operated by means of an external timer or separate remote-control system.
- No accessible metal parts after installation in accordance with user manual.

## Disposal Instructions

This appliance is labeled in compliance with European directive 2002/96/EC for Waste Electrical and Electronic Equipment (WEEE). By ensuring that this appliance is disposed of correctly, you will help prevent any possible damage to the environment and to human health, which might otherwise be caused if it was disposed of in the wrong way.

The symbol on the product indicates that it may not be treated as normal household waste. It should be taken to a collection point for the recycling of electrical and electronic goods.

This appliance requires specialist waste disposal. For further information regarding the treatment, recycle and recycling of this product please contact your local council, your household waste disposal service, or the shop where you purchased it.

For more detailed information about treatment, recovery and recycling of this product, please contact your local city office, your household waste disposal service or the shop where you purchased the product.



## WARNING!

Do not dispose of this product as unsorted municipal waste. Collection of such waste separately for special treatment is necessary.

# Product Structure

## Main Body

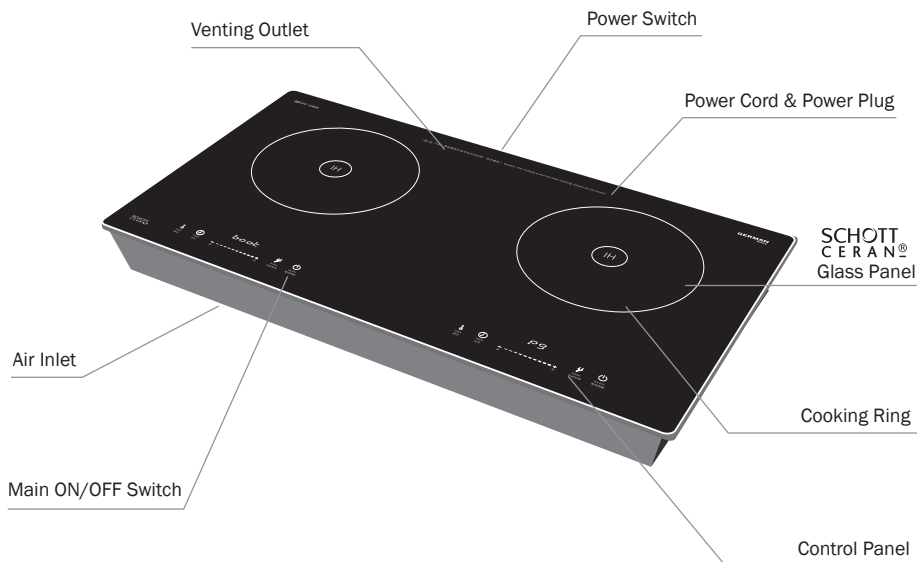

## Control Panel

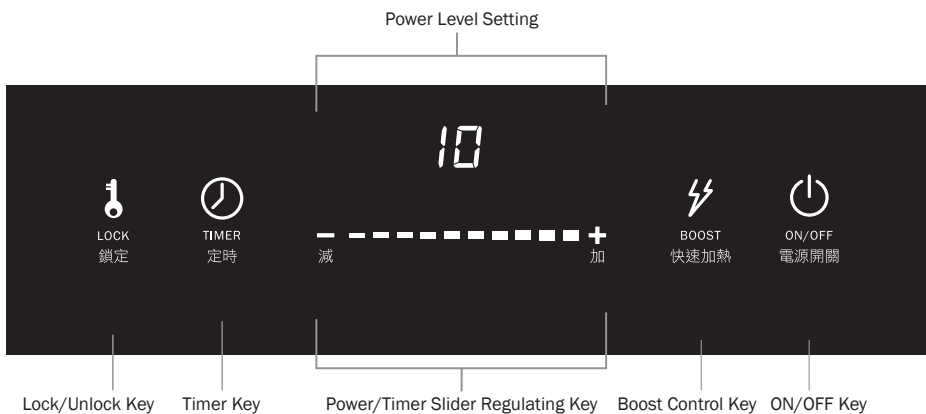

## Heating Zone Power

Heating Zone	Power Level 9	Max.Power (Boost)
Left Zone	2,400W	2,600W
Right Zone	2,400W	2,600W

# Installation Instructions

## Selection of Installation Equipment

Cut out the work surface according to the sizes shown in the drawing, leaving at least 5 cm space on all four sides around the hole. Be sure the thickness of the work surface is at least 30 mm. Please select heat-resistant materials for work surface to avoid damage or deformation caused by the heat radiation from the hotplate. As shown below:

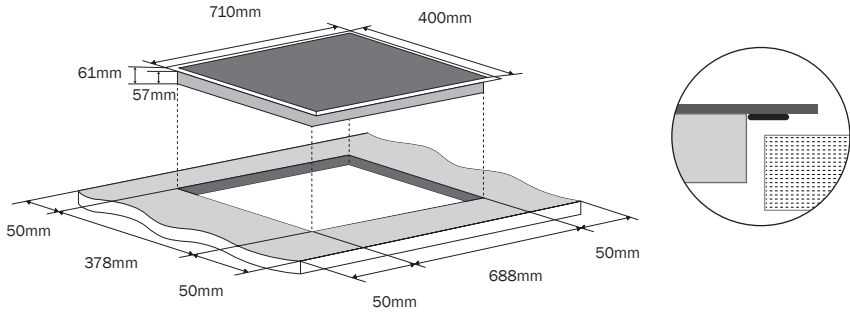

### WARNING!

Under any circumstances, make sure the Induction cooker is well ventilated and the air inlet and outlet are not blocked. Ensure the induction cooker is in good working condition. As shown below

The safe distance between the hotplate and the cupboard above the hotplate should be at least 760 mm.



# Installation Instructions

---

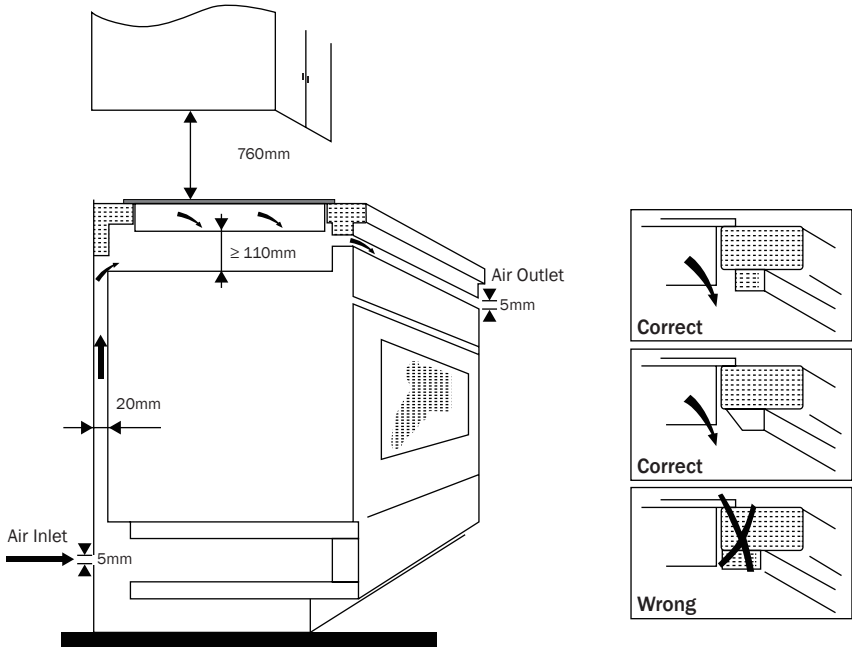

## Before You Install the Induction Cooker, Make Sure That

- The work surface is straight and level, and no other structural components interfering with the space required.
- The work surface is made of heat-resistant materials.
- If the induction cooker is installed above an oven, the oven has a built-in cooling fan.
- The installation will comply with all clearance requirements and applicable standards and regulations.
- A suitable isolating switch providing full disconnection from the mains power supply is incorporated in the permanent wiring, mounted and positioned to comply with the local wiring rules and regulations.
- The isolating switch must be of an approved type and provides a 3 mm air gap contact separation in all poles (or in all active [phase] conductors if the local wiring rules allow for this variation of the requirements).
- The isolating switch will be easily accessible to the user with the induction cooker installed.
- You consult local building authorities and by-laws if in doubt regarding the installation.
- You use heat-resistant and easy-to-clean finishes (such as ceramic tiles) for the wall surfaces surrounding the induction cooker.

# Installation Instructions

## When You Have Installed the Induction Cooker, Make Sure That

- The power supply cable is not accessible through cupboard doors or drawers.
- There is adequate flow of fresh air from outside the cabinetry to the base of the induction cooker.
- If the induction cooker is installed above a drawer or cupboard space, a thermal protection barrier is installed below the base of the cooker.
- The isolating switch is easily accessible by the user.

## Fastening the Cooktop to the Bench

1. Turn the cooktop upside down and place it on a soft surface.
2. Spread the seal around the edges of the ceramic glass with the adhesive side facing down, making sure that the whole perimeter is sealed. Cut off any excess material.
3. Mount the supplied clamps and screws onto the cooktop, as shown (without tightening the screws).
4. Place the cooktop into the cutout, then tighten the screws to clamp the cooktop securely to the bench.
5. Using a sharp cutter or trimmer knife, trim the excess sealing material around the edge of the cooktop. Take care not to damage the benchtop.

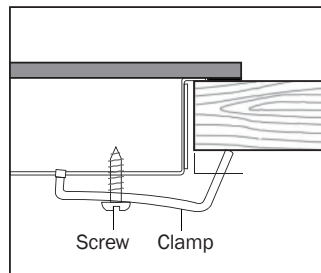
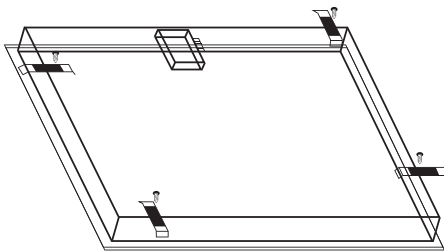

## Before Locating the Fixing Brackets

The unit should be placed on a stable, smooth surface (use the packaging). Do not apply force onto the controls protruding from the hob.



### Cautions:

- The induction cooker must be installed by a qualified personnel or technician. We have professionals at your service. Please never conduct the operation by yourself.
- The induction cooker will not be installed directly above a dishwasher, fridge, freezer, washing machine or clothes dryer, as the humidity may damage the cooker electronics
- The induction cooker shall be installed such that better heat radiation can be ensured to enhance its reliability.
- The wall and induced heating zone above the table surface shall withstand heat.
- To avoid any damage, the sandwich layer and adhesive must be resistant to heat.

# Installation Instructions

---

## Connecting the Induction Cooker to the Mains Power Supply

This induction cooker must be connected to the mains power supply only by a suitably qualified person. Before connecting the induction cooker to the mains power supply, check that:

1. The domestic wiring system is suitable for the power drawn by the induction cooker.
2. The voltage corresponds to the value given in the rating plate.
3. The power supply cable sections can withstand the load specified on the rating plate.



### Cautions:

- To connect the hob to the mains power supply, do not use adapters, reducers, or branching devices, as they can cause overheating and fire.
- The power supply cable must not touch any hot parts and must be positioned so that its temperature will not exceed 75 °C at any point.
- Check with an electrician whether the domestic wiring system is suitable without alterations. Any alterations must only be made by a qualified electrician.
- If the cable is damaged or to be replaced, the operation must be carried out by an after-sale agent with dedicated tools to avoid any accidents.
- If the appliance is being connected directly to the mains an omnipolar circuit-breaker must be installed with a minimum opening of 3mm between contacts.
- The installer must ensure that the correct electrical connection has been made and that it is compliant with safety regulations.
- The cable must not be bent or compressed.
- The cable must be checked regularly and replaced by authorized technicians only.

# Operating Instructions

Induction cooking is a safe, advanced, efficient, and economical cooking technology. It works by electromagnetic vibrations generating heat directly in the pan, rather than indirectly through heating the glass surface. The glass becomes hot only because the pan eventually warms it up.

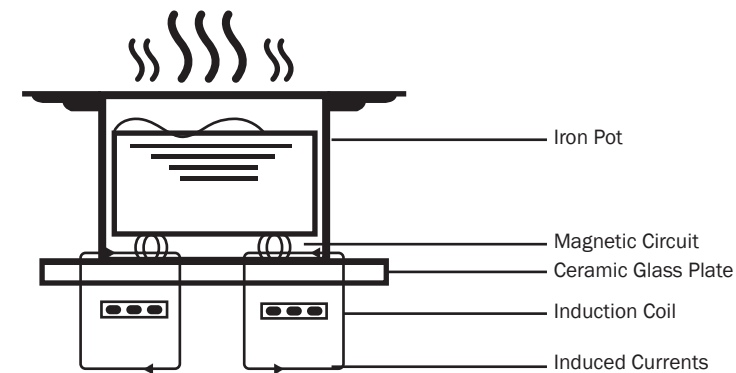

## Before Using Your New Induction Cooker

- Read this guide, taking special note of the 'Safety Warnings' section.
- Remove any protective film that may still be on your Induction Cooker.

## Choosing the Right Cookware

Do not use cookware with jagged edges or a curved base.



Make sure that the base of your pan is smooth, sits flat against the glass, and is the same size as the cooking zone. You can use pans which diameter is as large as the marked cooking zone. However, using a pot slightly larger than the marked cooking zone may be the most efficient use of energy; using a pot smaller than the marked cooking zone is the least efficient use of energy. Always center your pan on the cooking zone.

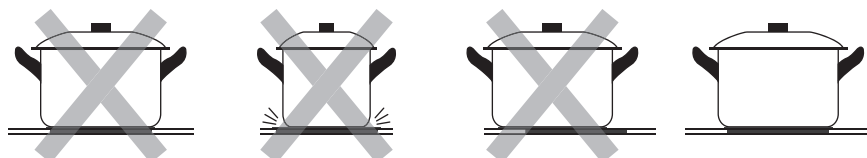

# Operating Instructions

---

Always lift pans off the Induction Cooker, do not slide, or they may scratch the surface of the glass.

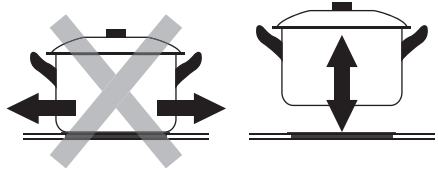

## Using the Touch Control

- The controls respond to touch, so you don't need to apply any pressure.
- Use the ball of your finger, not its tip.
- You will hear a beep each time a touch is registered.
- Make sure the controls are always clean, dry, and that there is no object, such as a utensil or a cloth, covering them. Even a thin layer of water may make the controls difficult to operate.

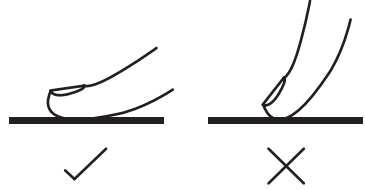

## Using Your Induction Cooker To Start Cooking

### 1. Touch the ON/OFF Key .

- After power on, the buzzer beeps once, all displays show “-”, indicating that the induction cooker has entered the state of standby mode.

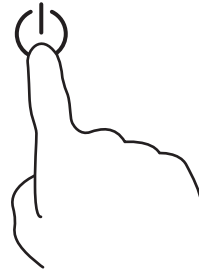

### 2. Place a suitable pan on the cooking zone that you wish to use.

- Make sure the bottom of the pan and the surface of the cooking zone are clean and dry.

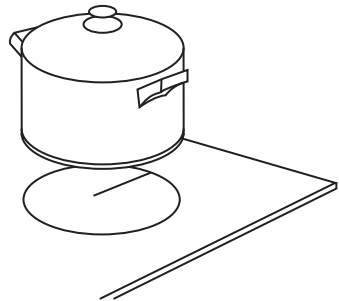

# Operating Instructions

## 3. Adjust heat setting by touching the Power/Timer Slider Regulating Key.

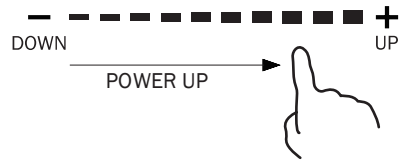

- If you don't choose a heat setting within 1 minute, the induction cooker will automatically switch off. You will need to start again at step 1.
- You can modify the heat setting at any time during cooking.

### Note:

If the display flashes  alternately with the heat setting

This means that:

- You have not placed a pan on the induction cooking zone or,
- The pan you're using is not suitable for induction cooking or,
- The pan is too small or not properly centered on the induction cooking zone.

No heating will take place unless there is a suitable pan on the cooking zone.

The display will automatically turn off after 1 minutes if no suitable pan is placed on the cooktop.

## When You Have Finished Cooking

### 1. Key Pressing

Press the ON/OFF Key , the power of the zone will be turned off straight away, or press the "-" key will decrease the power to "0" level,

### 2. Beware of Hot Surfaces

"H" will show which cooking zone is hot to touch. It will disappear when the surface has cooled down to a safe temperature. It can also be used as an energy saving function to heat up additional pans or pots, using the hotplate while it is still hot.

## Using the Boost Function

### Activating the Boost Function

Touching the Boost Control Key , the zone indicator show "10". and the power reach Max.

### Cancelling the Boost Function

Touching the Power/Timer Slider Regulating Key to cancel the Boost function, then the cooking zone will revert to Level before the Boost function.

- The cooking zone will return to Level 9 after five minutes.

## Using Child Lock Function

- You can lock the control keys to prevent unintended use (for example children accidentally turning on the cooking zones).
- When the control keys are locked, all the control keys are disabled, with the exception of the ON/OFF Key.

# Operating Instructions

## To Lock the Control Keys

Touch the Lock/Unlock Key  for 3 seconds. The timer indicator will show “Loc”.

## To Unlock the Controls

1. Make sure the induction cooker is turned on.
2. Touch and hold the Lock/Unlock Key  for a while.
3. You can now start using your cooker.



### Note:

When the induction cooker is in the lock mode, all the controls are disabled except ON/OFF Key, you can always turn the cooker off with the ON/OFF Key in an emergency, but you shall unlock the cooker first in the next operation.

## Auto Shutdown Protection

Auto shut down is a safety protection function for your induction cooker. It shuts down automatically if you ever forget to turn it off. The default working time for various power levels are shown in the below table:

Power Level	1-3	4-6	7-8	9
Default Working Timer (min)	240	180	120	90



### WARNING!

People with a cardiac pace maker should consult with their doctor before using this unit.

## Using the Timer

1. Hold down the Timer Key , and the time indicator flashes, you can set the timer at this point.
2. Using the Power/Timer Slider Regulating Key, you can set the timer from 1 to 120 minutes.
3. When the timer is set, it will begin to count down immediately. The display will show the remaining time.
4. When set time expires, the corresponding cooking zone will be switched off automatically.

# Troubleshooting

---

If an abnormality occurs, the induction cooker will enter the protective state automatically and display corresponding protective codes:

Error Message	Possible Reason	Solution
	No cookware has been detected or it is not an induction compatible cookware.	Replace the pot
ER03	There is water or a pot on the control panel	Clean the control panel



## **WARNING!**

The above are the possible reasons and suggested solution of some common failures. Please do not disassemble the unit by yourself to avoid any dangers and damages to the induction cooker and please contact the supplier.



# Technical Specifications

---

Model No.	GIC-152DB	GIC-128DB
Voltage	220-240V	
Frequency	50-60 Hz	
Cooking Zones	2	
Rated Power (Max)	5,200W Left: 2,600W Right: 2,600W	2,800W Left: 2,600W Right: 2,600W
Product Dimensions	(H) 61mm (W) 710mm (D) 400 mm (without feet)	
	(H) 80mm (W) 710mm (D) 400 mm (with feet)	
Cutout Dimensions	(H) ≥311mm (W) 688mm (D) 378mm	
Plugs	13A x 2#	13A x 1

#Consists of 2 separate and independent power cords. Two 13A power sockets are needed. Please make sure your household power cords are compatible.

Specifications are subject to change without prior notice.

If there is any inconsistency or ambiguity between the English version and the Chinese version, the Chinese version shall prevail.

Refer to [www.germanpool.com](http://www.germanpool.com) for the most up-to-date version of the Operating Instructions.

# 目錄

注意事項 19

產品結構 22

安裝說明 23

功能介紹 26

故障檢修 30

技術規格 30

保用條款 31

# 注意事項

---

感謝購買德國寶電磁爐產品。為了達到最佳使用效果及保障安全，請您在使用本設備前仔細閱讀本說明書，以便完全理解如何正確使用和操作以及相關安全事項。請保存本說明書以備日後參考。每件產品在出廠前都通過了質檢，請放心使用，相信您在使用過程中會得到滿意的體驗。

## 安裝 電擊危險

- 在對電磁爐進行任何工作，或者進行維修前，請斷開設備跟任何電源供應的連接。
- 連接到一個合格的接地系統，是必不可少和強制性的。
- 只有合格的電工才能對布線系統進行修改。
- 如果不遵循這些建議，可能會導致電擊或死亡。

## 減少傷害

- 注意鋒利的面板邊緣。
- 不遵循警示，可能會導致受傷或割傷。

## 重要安全說明

- 在安裝或使用此設備前，請仔細閱讀這些說明。
- 任何時候都不應將易燃材料或產品放置在電磁爐上。
- 為避免危險，必須按照安裝說明安裝此設備。
- 只有具備適當資格的人員才能正確安裝和連接此設備。
- 此設備應連接到一個包含隔離開關的電路上，與電源完全斷開。
- 未能正確安裝此設備可能會導致任何保修或責任索賠失效。

## 操作和維護

### 電擊危險

- 請勿在破損或有裂縫的電磁爐上做飯。如果電磁爐表面出現破損或裂紋，應立即在主電源（牆壁開關）將其關閉，並與合資格的技術人員聯繫。
- 在清洗或維修前，必須將電磁爐關掉。
- 如果不遵循這建議，可能會導致電擊或死亡。

## 健康危害

- 此設備符合電磁安全標準。
- 然而，使用心臟起搏器或其他電子植入物（如胰島素泵）的人在使用此設備之前必須諮詢醫生或植入物製造商，以確保他們的植入物不會受到電磁場的影響。
- 若不遵守此建議，可能會導致死亡。

## 電磁爐表面高溫危險

- 在使用過程中，此設備的可接近部分會變得高溫，可能導致燒傷。
- 在電磁爐晶板表面冷卻之前，不要讓您的身體、衣服或任何物品接觸電磁爐表面，除了合適的鍋具。
- 在電磁爐表面開始發熱後，刀、叉、匙、蓋等金屬物品不應放在電磁爐表面。
- 讓孩子遠離此設備。
- 鍋柄溫度過高，不能觸摸，檢查鍋柄不要置於其他烹飪區域上方；讓鍋柄遠離孩子們能觸碰的區域。
- 若不遵循此建議，可能會導致燒傷和燙傷。

# 注意事項

## 切割危害

- 當鏟刀的安全蓋縮回時，灶台鏟刀的鋒利刀片會暴露在外。使用時請特別小心，並始終存放在安全的地方，避免兒童接觸。
- 不謹慎可能會導致受傷或割傷。

## 重要的安全使用說明

- 使用時請不要讓此設備處於無人看管狀態。沸騰會導致煙霧和油脂溢出，可能會引發火災。
- 永遠不要將此設備用作工作或存放物品的存儲區域。
- 切勿將任何物品或器具留在電磁爐上。
- 請勿將任何可磁化的物品(如信用卡、存儲卡)或電子設備(如電腦、MP3播放器)放置在此設備上或附近，以免受到其電磁場影響。
- 切勿使用電磁爐來加熱房間。
- 使用完畢後，請按本手冊中的說明(即使用輕觸控制)關閉烹飪區域和電磁爐。當您移開鍋具時，不要依賴鍋具檢測功能來關閉烹飪區域和電磁爐。
- 不允許兒童和電磁爐玩耍，或坐、站、爬上電磁爐。
- 切勿把兒童感興趣的物品放在電磁爐上方的櫃子裡。可能會導致爬上電磁爐的孩子受重傷。
- 在使用電器的區域內，不要讓兒童獨處或無人看管。
- 兒童或殘疾人士有限制性地使用此設備，應有一名負責任和有能力的人指導他們使用此設備。指導者應確信他們能夠在不危及自身或周圍環境的情況下使用此設備。
- 除非說明書中特別建議，否則不要修理或更換此設備的任何部分。所有其他服務應由合資格的技術人員進行。
- 切勿用蒸汽清潔器清潔電磁爐。
- 切勿在電磁爐上放置或掉落重物。
- 切勿站立於電磁爐上。
- 切勿使用邊緣有鋸齒的鍋具，或者將鍋具拖過玻璃表面，否則會刮傷玻璃。
- 切勿使用洗碗機或任何其他粗糙的研磨性清潔劑來清潔此設備，因為它們會刮傷玻璃。
- 如果電源線損壞，必須由製造商、其服務代理或類似的合資格人員更換，以避免危險。
- 本設備適用於家庭及類似用途，如：商店內的員工廚房區域、辦公室及其他工作環境中的廚房區域；農場的房子；酒店、汽車旅館和其他類型居住環境。



## 警告!

- 在使用過程中，此設備及其可接觸部件會發熱。應注意避免接觸加熱元件。未滿8歲的兒童，除得到監護外，不得靠近。
- 如在安全的方式得到監督和理解所涉及的危險，或有人指導有關使用此設備的方法，可以讓8歲以上兒童和殘疾人士，或缺少身體感覺或精神能力，或缺乏經驗和知識的人使用此設備。
- 不允許兒童和電磁爐玩耍，兒童在沒有監護的情況下，不得進行清潔或維修。
- 沒有人看管烹煮食物的情況下，會非常危險，可能會導致火災。切勿用水滅火，但應關掉電器，然後用蓋子或滅火毯蓋住火焰。
- 火災危險！請勿在烹飪表面區域存放任何物品。
- 如果表面有裂紋，請關閉設備，以避免觸電的可能性。電磁爐表面的微晶玻璃或類似材料是用於保護帶電部件。
- 切勿使用蒸汽清潔器清潔本設備。
- 此設備不能通過外部定時器或單獨的遠程控制系統來操作。
- 根據說明書正確安裝後，沒有剩餘的可觸及金屬組件。

# 注意事項

---

## 環保及再造

此設備的標籤符合歐洲指令2002/96/EC關於廢棄電器和電子設備(WEEE)的規定。透過確保正確處理此設備，您將有助於防止任何可能對環境和人類健康造成的損害。

該產品上的標誌表明，它不能作為正常的生活垃圾處理。它應該被帶到一個回收點，用於回收電器和電子產品。

此設備需要專門廢物處理。如需有關此設備的處理、回收及循環再造的進一步資料，請與當地家居廢物處理服務機構或購買本產品的商店聯絡。

有關本產品的處理、回收及循環再造的詳細資料，請聯絡當地的城市辦事處、家居廢物處理服務或購買本產品的商店。



### 警告！

請勿將此產品作為未分類的城市垃圾處理，集合這樣分別特殊廢物處理是必要的。

# 產品結構

## 主機

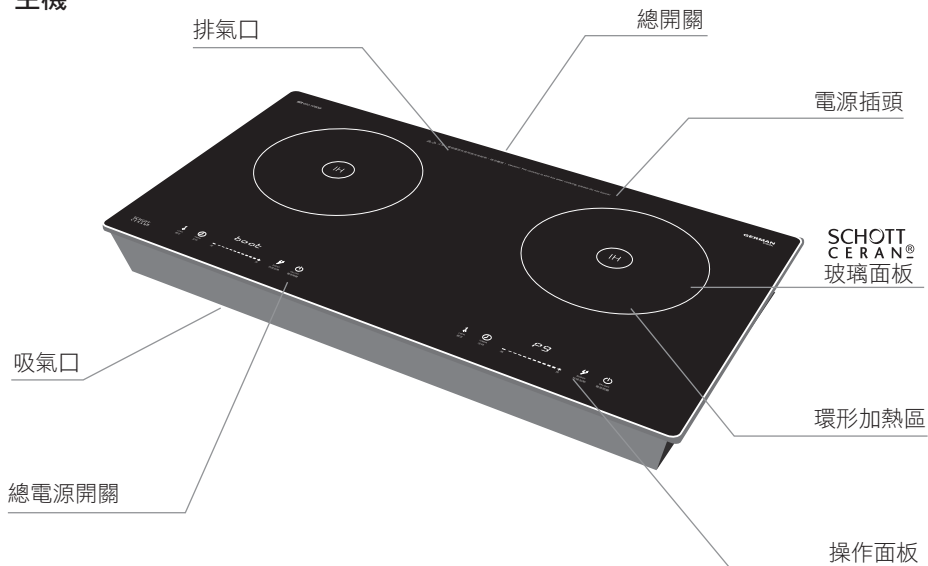

## 控制面板

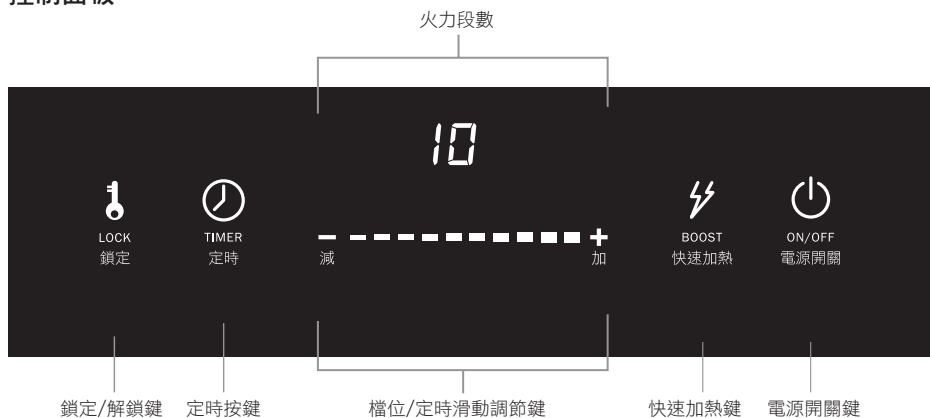

## 加熱區功能

加熱區	功率等級9	最大功率 (快速加熱)
左側區域	2,400W	2,600W
右側區域	2,400W	2,600W

# 安裝說明

## 安裝設備選擇

請根據下圖所顯示的尺寸為廚櫃檯面開孔。為方便安裝和使用，開孔周圍應至少預留50毫米空間。請確保廚櫃檯面的厚度至少為30毫米，並選擇耐熱的廚櫃材料，避免電磁爐的熱輻射引起廚櫃顯著的變形。

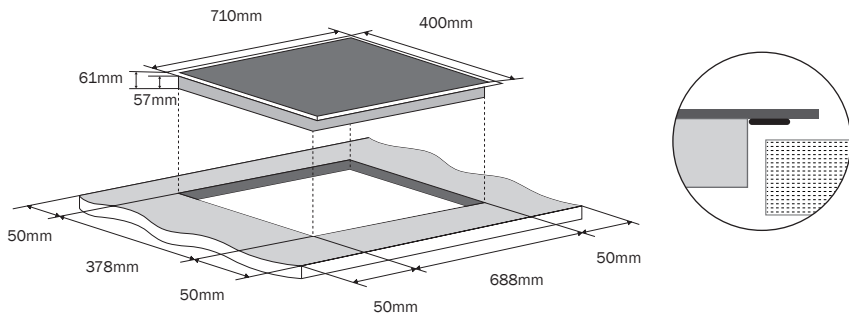

### 警告：

在任何情況下，請確保電磁爐通風良好，進出風口不堵塞，以確保電磁爐處於良好的工作狀態。

電磁爐與其上方廚櫃之間的安全距離至少為760毫米。

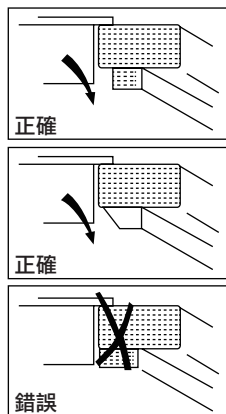
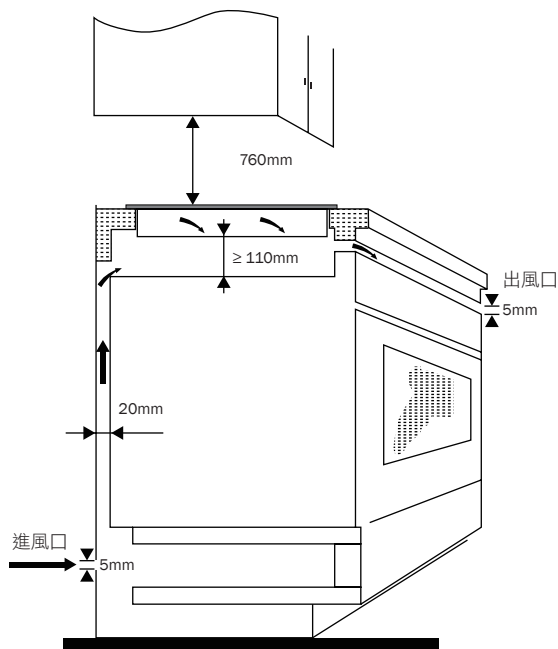

# 安裝說明

## 安裝前注意事項

- 廚櫃檯面必須為方而平，無結構組件阻礙或干擾安裝電磁爐的空間。
- 廚櫃檯面是由耐熱材料製成的。
- 如果電磁爐安裝在烤爐上方，烤爐必須要有內置的冷卻風扇。
- 安裝符合所有清關要求和適用的標準和法規。
- 永久性布線中包含一個適當的隔離開關，該開關提供與主電源完全斷開的連接，其安裝和定位應符合當地布線規則和規定。
- 隔離開關必須是經批准的類型，並在所有電極(或在所有有源[相]導體中，如果本地布線規則允許要求的這種變化)提供3毫的氣隙接觸隔離。
- 安裝電磁爐後，隔離開關可令使用更方便
- 如果對安裝有疑問，請諮詢當地建築局和規章制度。
- 電磁爐周圍的牆壁表面請使用耐熱和易於清潔的物料，如瓷磚。

## 安裝時注意事項

- 電源線不能通過櫃門或抽屜進入。
- 有足夠的新鮮空氣從櫥櫃外部流向電磁爐底座。
- 如果電磁爐安裝在抽屜或櫥櫃空間上方，則在電磁爐底座下方設置熱防護屏障。
- 安裝隔離開關以使用戶使用。

## 將電磁爐固定於檯面上

1. 反轉電磁爐，並放置於平整的檯面上。
2. 將密封條沿微晶玻璃邊緣展開，一面朝下，確保整個圓周密封，剪掉多餘的材料。
3. 把包裝內提供的固定扣和螺絲裝進電磁爐，不需要鎖緊螺絲。
4. 把電磁爐嵌入進開孔，然後鎖緊螺絲區夾住電磁爐到檯面上。
5. 使用尖刀，修剪電磁爐邊緣多餘的密封條，請注意不要損壞電磁爐表面。

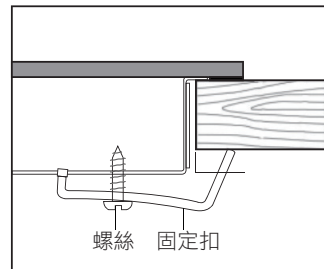
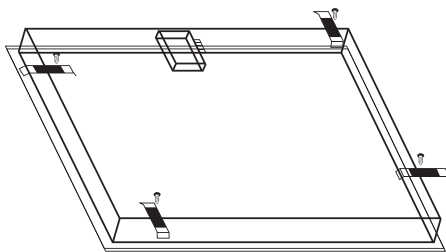



# 安裝說明

## 在定位固定支架前

本機應放在平穩、光滑的表面上（使用包裝）。不要對突出於電磁爐上的控制施加壓力。



### 警告：

- 電磁爐必須由合格人員或技術人員安裝，請勿自行操作。
- 電磁爐不能直接安裝在洗碗機、雪櫃、洗衣機或乾衣機上方，因為濕度可能會損壞電磁爐。
- 應安裝電磁爐，以保證更好的熱輻射，提高其可靠性。
- 檯面以上的牆面和電磁加熱區應能承受熱量。
- 為避免任何損壞，夾層和粘接劑必須耐熱。

## 將電磁爐連接至主電源

電磁爐必須由適當的合資格人員連接到主電源，在將電磁爐連接到主電源前請檢查以下事項：

1. 所在地區的配線系統適用於電磁爐牽引電源。
2. 所在地區的電壓與銘牌上的數值相對應。
3. 電源電纜段能夠承受銘牌上規定的負載。



### 警告：

- 要將電磁爐連接到主電源，請勿使用適配器、減速器或分支設備，因為它們會引起過熱和火災。
- 電源線不能接觸任何熱部件，必須定位使其溫度在任何時候都不會超過攝氏75度。
- 請與電工檢查所在地區的布線系統是否適合，而不需要改變，如有改動必須由合格的電工進行。
- 如電源線損壞或需要更換，必須由售後代理使用專用工具進行維修，以免發生意外。
- 如果電磁爐直接連接到電源，必須安裝全極性斷路器，觸點之間的最小開度為3毫米。
- 安裝人員必須確保正確的電氣連接，並符合安全規定。
- 電源線不得彎曲或壓扁。
- 電纜必須定期檢查，只有授權的技術人員才能更換。

# 使用說明

電磁爐烹飪是一種安全、先進、高效、經濟的烹飪技術。它的工作原理是電磁振動直接在鍋內產生熱量，而不是通過加熱玻璃表面間接產生熱量。微晶玻璃變熱只是因為平底鍋的接觸最終使它加熱。

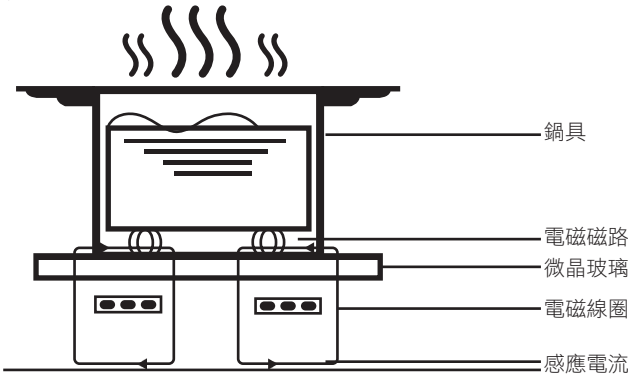

## 在使用您的新電磁爐前

- 閱讀此指引，注意安全警告部分的內容。
- 移除任何殘留在電磁爐上的保護膜。

## 鍋具選擇

請勿使用邊緣參差不齊或底部彎曲變形的鍋具。

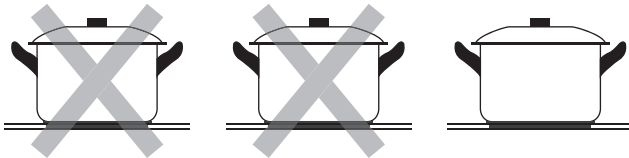

請確保鍋具的底部是光滑的，平放在玻璃上，鍋底大小符合電磁爐烹飪區域面積。請使用直徑符合電磁爐烹飪區域上的標示的鍋具。如使用一個稍微寬一點的鍋具，能源將被最大效率地使用。如果使用較小的鍋，效率可能低於預期，請始終把你的鍋具放在電磁爐烹飪區域中央。

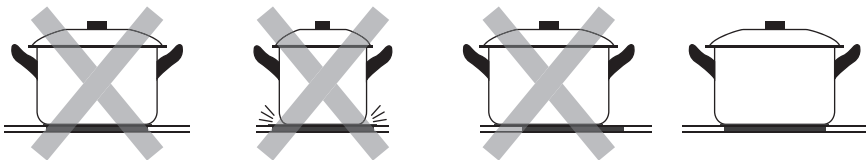

移動鍋具時，請完全提起鍋具離開電磁爐，切勿拖動，否則可能會刮花微晶玻璃。

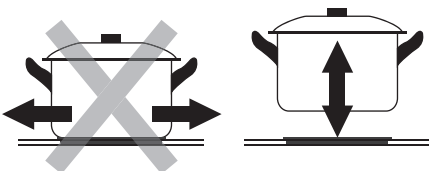

# 使用說明

## 使用輕觸按鍵

- 控制器對輕觸有反應，所以你不需要施加任何壓力。
- 使用時用你的手指指腹，而不是指尖。
- 每次輕觸的時候，你會聽到一個蜂鳴聲，代表電磁爐收到指令並回覆。
- 確保控制部分始終是乾淨、乾燥的，並且沒有任何物體（例如器具或布）覆蓋它們。即使是薄薄一層水也可能使控制面板難以操作。

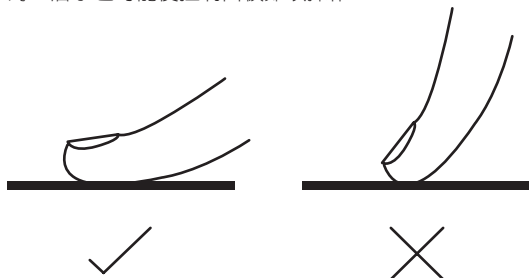

## 開始烹飪

1. 輕觸「電源開關鍵」 啟動電磁爐。

- 開機後，蜂鳴器響聲一次，全部的顯示區域會顯示「-」，表示電磁爐已進入待機狀態。

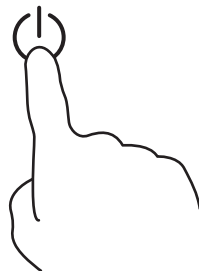

2. 在烹飪區放置合適的鍋具。

- 確保鍋具的底部和烹飪區的表面是乾淨和乾燥的。

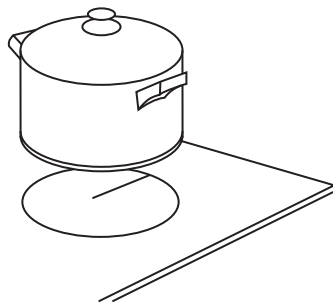

# 使用說明

3. 通過滑動或輕觸「檔位/定時滑動調節鍵」來調節加熱設置。

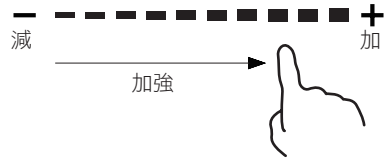

- 如果在1分鐘內沒有選擇加熱設置，電磁爐會自動關閉，您需要重新開始第一步。
- 烹飪過程中，您可以隨時調整加熱設置。



## 注意：

如果顯示屏顯示「E」與加熱設置交替閃爍，表示：

- 您沒有在烹飪區位置放置鍋具；
- 您使用的平底鍋不適合電磁爐烹飪；
- 鍋具太小或沒有正確地放置於烹飪區中間。

除非在烹飪區有一個合適的鍋具，否則無法加熱。1分鐘後如果沒有合適的鍋具放置在加熱區域中，顯示屏會自動關閉。

## 完成烹飪

1. 按「電源開關鍵」，電源就會被切斷，或輕觸「-」鍵將功率降低到「0」檔。
2. 小心電磁爐表面高溫，「H」將顯示哪個烹飪區域是過熱的，表示不能觸碰。當電磁具表面冷卻到安全溫度時，它就會消失。如果您想進一步用餘熱加熱鍋具，它也可以被用作一個節能功能。

## 使用快速加熱功能

### 啟用功能

按「快速加熱鍵」，顯示屏會顯示「10」，然後功率會調整至最大。

### 取消功能

按「檔位/定時滑動調節鍵」取消快速加熱功能，然後烹飪區域會恢復到您所選擇的檔位。

- 烹飪區會在5分鐘後，回到9檔。

## 使用童鎖功能

- 您可以鎖定控制，以防止意外使用（例如兒童不小心打開烹飪區）。
- 當控制被鎖定時，除「電源開關鍵」外的所有控制都被禁用。

# 使用說明

## 鎖定控制



長按「鎖定/解鎖按鍵」 3秒，顯示屏會顯示「Loc」。

## 解鎖控制

1. 確保電磁爐是開機狀態。
2. 長按「鎖定/解鎖按鍵」 一段時間。
3. 現在您可以開始使用您的電磁爐。



### 注意：

當電磁爐處於鎖定模式時，除「電源開關鍵」 外的控制都被禁用的，在緊急情況下，您始終可以使用「電源開關鍵」 關閉電磁爐，但是您應該在下一個操作中，先解鎖電磁爐。

## 自動關機保護

自動關機是電磁爐的安全保護功能。如果你忘記關機，它就會自動關閉。不同功率檔位的默認工作時間如下表所示：

檔位	1-3	4-6	7-8	9
默認工作時間 (分鐘)	240	180	120	90



### 警告：

心臟起搏器使用者在使用前應諮詢醫生。

## 使用定時

1. 按下「定時按鍵」，計時指示燈閃爍，此時你可以設置定時。
2. 使用「檔位/定時滑動調節鍵」，可以實現1-120分鐘的計時設置。
3. 設定好時間後，電磁爐會立即開始倒計時，顯示屏將顯示剩餘的時間。
4. 當烹飪計時器到時間時，相應的烹飪區域將自動關閉。

# 故障檢修

當出現故障或異常時，電磁爐會自動進入保護狀態，並顯示相應的保護碼：

錯誤代碼	可能導致的原因	解決方案
	無鍋具或使用不適合電磁爐使用的鍋具	更換鍋具
ER03	有水或鍋具在控制介面上	清理控制面板



## 警告!

以上是對常見故障的判斷和檢查。請勿自行拆卸本機，以免對電磁爐造成任何危險和損壞。  
如遇故障請與供應商聯繫。

# 技術規格

型號	GIC-152DB	GIC-128DB
電壓	220-240V	
頻率	50-60 Hz	
爐頭數目	2	
額定功率(最大)	5,200W 左：2,600W 右：2,600W	2,800W 左：2,600W 右：2,600W
機身尺寸	(H) 61mm (W) 710mm (D) 400 mm (不連腳)	
	(H) 80mm (W) 710mm (D) 400 mm (連腳)	
開孔尺寸	(H) ≥311mm (W) 688mm (D) 378mm	
插頭	13A x 2#	13A x 1

#擁有兩條獨立電源線，需使用兩個獨立13A電源插座，請先檢查供電插座是否可承受此負荷。

產品規格及設計如有變更，恕不另行通知。

中英文版本如有出入，一概以中文版為準。

本產品使用說明書以www.germanpool.com 網上版為最新版本。

# 保用條款

此保用提供德國寶產品之機件在正常使用下壹年保用 (自購買日起計算)。

# Warranty Terms & Conditions

Under normal operations, the product will guarantee a 1-year full warranty provided by German Pool (effective from the date of purchase).

\* 貴戶須在購機十天內，以下列其中一種方式向本公司登記資料，保用手續方正式生效：

- 1) 填妥德國寶VIP手機應用程式保用登記表 (掃描右方二維碼)
- 2) 填妥本公司網頁保用登記表  
[www.germanpool.com/warranty](http://www.germanpool.com/warranty)
- 3) 填妥保用卡郵寄至本公司。



\* This warranty is not valid until customer registration information is received by our Service Centre within 10 days of purchase via one of the following means:

- 1) Visit our VIP App and register online:  
(Scan the QR Code on the right)
- 2) Visit our website and register online:  
[www.germanpool.com/warranty](http://www.germanpool.com/warranty)
- 3) Complete the attached Warranty Card and mail it back to our Customer Service Centre.



另請填妥以下表格並與正本發票一併保存，以便維修時核對資料。用戶提供之所有資料必須正確無誤，否則免費保用將會無效。 Please fill out the form below. This information and the original purchase invoice will be required for any repairs. Warranty will be invalidated if information provided is found to be inaccurate.

型號 Model No. :  GIC-128DB  GIC-152DB

機身號碼 Serial No. : \_\_\_\_\_ 發票號碼 Invoice No. : \_\_\_\_\_

購買商號 Purchased From : \_\_\_\_\_ 購買日期 Purchase Date : \_\_\_\_\_

1. 未能出示購買發票正本者，將不獲免費維修服務。
2. 用戶應依照說明書的指示操作。本保用並不包括：
  - 上門安裝、檢驗、維修或更換零件之人工以及一切運輸費用；
  - 因天然與人為意外造成的損壞 (包括運輸及其他)；
  - 電源接合不當、不依說明書而錯誤或疏忽使用本機所引致之損壞。
3. 於下列情況下，用戶之保用資格將被取消：
  - 購買發票有任何非認可之刪改；
  - 產品被用作商業或工業用途；
  - 產品經非認可之技術人員改裝或加裝任何配件；
  - 機身編號被擅自塗改、破壞或刪除。
4. 總代理有權選擇維修或更換配件或其損壞部份。
5. 產品一經被轉讓，其保用即被視作無效。

1. Customer who fails to present original purchase invoice will not be eligible for free warranty service.
2. Customer should always follow the operating instructions. This warranty does not apply to:
  - labour costs for on-site installation, check-up, repair, replacement of parts and other transportation costs;
  - damages caused by accidents of any kind (including material transfer and others);
  - operating failures resulting from applying incorrect voltage, improper usage, and unauthorized installations or repairs.
3. This warranty is invalid if:
  - the purchase invoice is modified by an unauthorized party;
  - the product is used for any commercial or industrial purposes;
  - the product is repaired or modified by unauthorized personnel, or unauthorized parts are installed;
  - the serial number is modified, damaged or removed from the product.
4. German Pool will, at its discretion, repair or replace any defective part.
5. This warranty will be void if there is any transfer of ownership from the original purchaser.

## 客戶服務及維修中心

中國香港

九龍大業街59號

三湘九龍灣貨運中心地下B室

電話：+852 2773 2888

傳真：+852 2356 9798

電郵：[repairs@germanpool.com](mailto:repairs@germanpool.com)

中國澳門

澳門青洲大馬路(青洲新路)

515號美居廣場第二期1樓A座

電話：+853 2875 2699

傳真：+853 2875 2661

## Customer Service & Repair Centre

Hong Kong, China

Unit B, G/F, Sunshine Kowloon Bay

Cargo Centre, 59 Tai Yip Street,

Kowloon, Hong Kong

Tel : +852 2773 2888

Fax : +852 2356 9798

Email : [repairs@germanpool.com](mailto:repairs@germanpool.com)

Macau, China

A, 1 Andar, Mei Kui Kuong Cheong Fase 2,

No.515 Avenida Do Conselheiro Borja

Macau

Tel : +853 2875 2699

Fax : +853 2875 2661

此保用只適用於香港及澳門

This warranty is valid only in Hong Kong and Macau

## German Pool (Hong Kong) Limited

### Hong Kong, China

Room 113, Newport Centre Phase II, 116 Ma Tau  
Kok Road, Tokwanan, Kowloon, Hong Kong.  
Tel: +852 2773 2888  
Fax: +852 2765 8215

### Mainland, China

8th, Xinxiang Road, Wusha Industrial Park,  
Daliang, Shunde, Foshan, Guangdong  
Tel: +86 757 2219 6888  
Fax: +86 757 2219 6809

### Macau, China

A, 1 Andar, Mei Kui Kuong Cheong Fase 2,  
No.515 Avenida Do Conselheiro Borja, Macau  
Tel: +853 2875 2699  
Fax: +853 2875 2661



香港《S MARK》  
安全認證



中國櫥櫃/家電行業  
十大影響力品牌



CEO非凡品牌大賞



香港優質商標



香港工商業獎



2007  
最具價值  
創星品牌企業獎



香港中小企業  
最佳成績大獎



香港消費者推祟品牌



香港《Q標》  
優質服務證書



香港名牌十年成就獎  
HONG KONG TOP BRAND TEN YEAR  
ACHIEVEMENT AWARD

©All rights reserved. Copying, reproducing or using the contents of this manual is not allowed without prior authorization from German Pool, violators will be prosecuted.