

Built-In Induction Cooker | GIC-CS28B-S



Online Warranty Registration



Please read these instructions and warranty information carefully before use and keep them handy for future reference.

USER MANUAL

請即進行保用登記!

有關保用條款細則，請看本說明書最後一頁。

Please register your warranty information now!

For Warranty Terms & Conditions,

please refer to the last page of this user manual.

Table of Contents

Warnings and Recommendations	04
Product Structure	05
Installation Instructions	06
Operating Instructions	08
Cleaning & Maintenance	09
Troubleshooting	10
Technical Specifications	10
Warranty Terms & Conditions	19

Warnings and Recommendations

WARNING!

- If the surface of the Cooktop is cracked, switch off the appliance to avoid the possibility of electric shock.
 - Metallic objects such as knives, forks, spoons and lids should not be placed on the induction hotplate since they can get hot.
 - This appliance is intended to be used in indoor household ONLY.
 - This appliance is not intended to be operated by means of an external timer or separate remote control system.
 - The temperature of accessible surfaces may be high when the appliance is operating.
 - If the supply cord is damaged, it must be replaced by the manufacturer, its service agent or similarly qualified person in order to avoid a hazard.
-
- When the user powered on the appliance without pressing any Control Button, the appliance will stop heating automatically in 1 hour 45 minutes to 2 hours 15 minutes and goes into Standby Mode; this ensures the safety of the appliance.
 - Single 13 A power jack must be used. Do not share power jack with other appliances.
 - Do not apply water directly onto the Induction Cooker.
 - Do not insert any wire or metal objects through the Air Inlet or Venting Outlet of the Induction Cooker.
 - Please avoid clashing cookware on the Cooktop.
 - A distance of at least 10cm between the wall and the sides of the Induction Cooker must be maintained for venting purposes.
 - Do not place or use the Induction Cooker near any heat source.
 - Do not heat up any metal plate or other magnetic objects on the Cooktop.
 - Do not heat empty cookware for an extended period of time. Overheating of cookware will cause damages and injuries.
 - Do not heat up unopened cans on the Cooktop. It may cause explosion.
 - Unplug the Power Cord when the Induction Cooker is not in use for a long period of time.
 - This appliance is not intended for use by persons (including children) with reduced physical, sensory or mental capabilities, or those lack experience and knowledge, unless they have been given supervision or instruction concerning the use of the appliance by a person responsible for their safety.
 - Children should be supervised to ensure that they do not play with the appliance.
 - Cannot use steam cleaner.
 - After use, please press the “ON/OFF” key  to turn off the Induction Cooker.
 - This appliance is intended to be used in household and similar applications such as:
 - staff kitchen areas in shops, offices and other working environments;
 - farm houses;
 - by clients in hotels, motels and other residential type environments.

Product Structure

Main Body

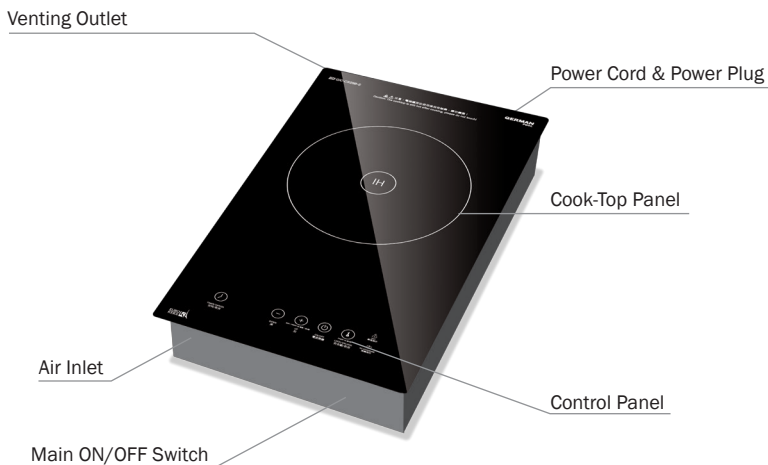

Control Panel

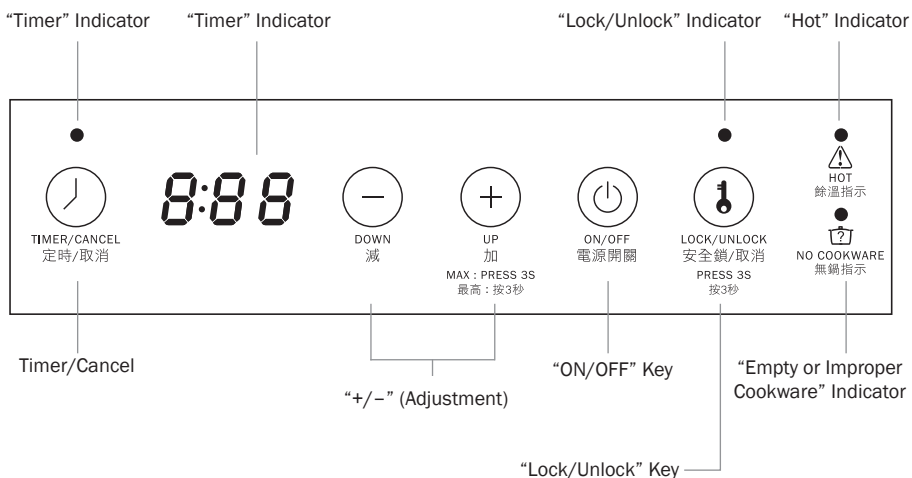

Installation Instructions

⚠ Notice

- There should not be any obstacles surrounding the unit.
- Make sure power plug is accessible after installation. Power outlet must be earthed.

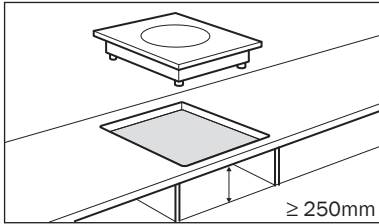

1. For ventilation purposes, there should be ≥ 250 mm in height of empty space under the unit body.

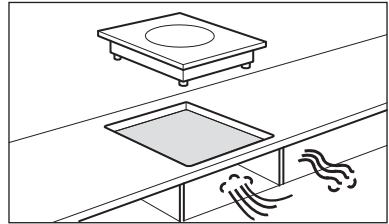

2. Air vent under the unit must be well circulated. Circulation between space under the unit and room atmosphere should be present.

Procedures

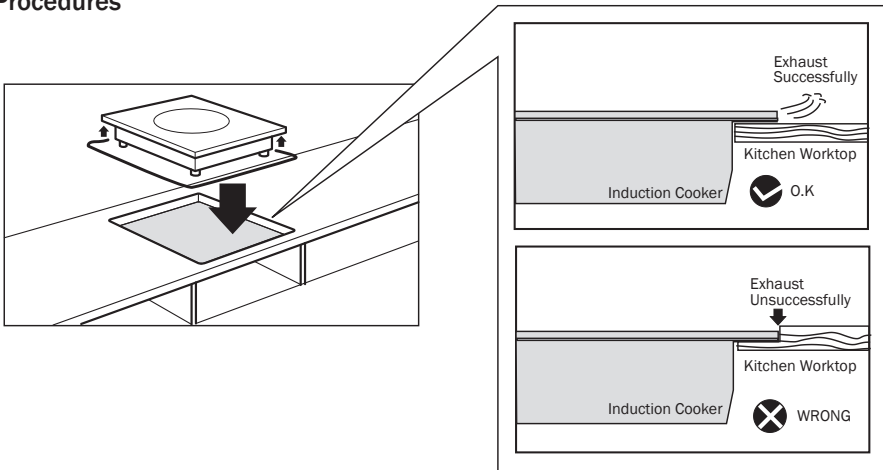

1. According to cutout dimensions $\geq 267\text{mm(W)} \times \geq 465\text{mm(D)}$, make a cutout hole on the cabinet / counter top.
2. Attach the supplied rubber tape to the bottom part of the unit body, and then place unit through the cutout hole.
3. Connect power and the Induction Cooker is ready to use.

Note: When the induction cooker is installed, the exhaust outlet must be put ONTO the kitchen work-top, so that it can exhaust successfully. Please refer to the above pictures.

Operating Instructions

Cookware

Please use only German Pool authorized cookware or cookware recommended by us. Any unauthorized cookware may affect induction cooker's heating capacity and quality.

Appropriate Cookware

- **Material:** Metal, ferromagnetic stainless steel or cast iron.
- **Shape:** Flat bottom with a diameter of 12cm or more. Cookware bottom diameter should not exceed 25cm and must not weight over 6kg (with food).



Ferromagnetic
Stainless Steel
Water Pot



Metal Frying Pan



Ferromagnetic
Stainless Steel
Cooking Pot



Metal Saucepan



Ferromagnetic
Metal Water Pot



Cast Iron Grilling
Pan

Inappropriate Cookware

- **Material:** Non-metallic, non-ferromagnetic, ceramic, glass, aluminum or brass.
- **Shape:** Bottom not flat or too bumpy, or bottom diameter smaller than 8cm.



Aluminum
Water Pot



Glass Pot



Ceramic Pot



Pot With Non-Flat/
Curved Bottom



Pot With
Bumpers



Pot Bottom
Too Small

Control Buttons Functions

“ON / OFF” Key

Under “Sleep” mode, press this key to enter “Standby” mode. Press again to return to “Sleep” mode.

“TIMER” Key

Under “Heating” mode, press this key to enter “Timed Heating” mode. Under “Timed Heating” mode, press this key to cancel timer and continue heating with the power level set previously.

“+/-” Adjustment Key

Under “Heating” or “Timed Heating” mode, press to set power level. Or, within 5 seconds after pressing “Timer” key, press to adjust timer.

“LOCK/UNLOCK” Key

When induction cooker is operating, press this key to enter “Lock” mode. Under “Lock” mode, besides On/Off key, all other keys cannot be operated. Press this key again for 3 seconds to enter “Unlock” mode. Under “Unlock” mode, all keys can be operated.

Operating Procedures

1. Put the power plug into the socket. Switch on the “Main ON/OFF switch”, a beep sound will be heard. The induction cooker enters standby mode. If no button is pressed for 30s, induction cooker will automatically enter sleeping mode.
2. Place cookware onto the centre of the cook-top panel. Press “+/-” switch to enter “Heating” mode (preset as power level 3).
3. Under “Heating” mode, press “+/-” key to adjust power level. Press “+” key 3s to “HH”, the max level.
4. The induction cooker will limit the power automatically when the inappropriate cookware is put on, the pressing of “+” key will not be available and the “Empty or Improper Cookware Indicator” and “E1” will flash as a warning.
5. Under “Heating” mode, press “TIMER” key to enter “Timed Heating” mode. Within 5 seconds of pressing the key, “Timing” Indicator will flash and show a flashing “0:30”. Press “-/+” to adjust heating time (1 minute – 9 hours 59 minutes). The unit of adjustment is 1 minute. Press for a longer while to increase the unit of adjustment. After 5 seconds of adjusting, “Timing” Indicator will change from flashing to lighting up. The time is set.
6. Under “Timed Heating” mode, press “TIMER” key to enter “Heating” mode.
7. When induction cooker is operating, press “LOCK/UNLOCK” key to enter “Lock” mode. Press this key again for 3 seconds to enter “Unlock” mode.
8. When induction cooker is operating, press “ON/OFF” switch to stop operating and enter “Sleep” mode.
9. In the following conditions, induction cooker will automatically exit “Heating” and enter “Standby” mode:
 - (Under “Heating” mode) no appropriate cookware is placed on the cook-top for 30 seconds
 - (Under “Heating” mode) no button is pressed for 120 minutes
 - The another abnormal situations. Under the “Standby” mode, the induction cooker will enter the “sleeping” after 30s.
10. When finish, press “ON/OFF” switch to turn off induction cooker.

Fault Code and Description

Fault Code	Fault Description	Fault Code	Fault Description
E0	Internal circuit error	E4	Under-voltage
E1	Without cookware or incompatible cookware used	E5	Top plate sensor open/short circuit
E2	IGBT overheat	E6	IGBT sensor open /short circuit
E3	Over-voltage	E7	Top plate overheat

*E3 & E4 are not product errors. Operation can be resumed when power voltage returns to normal rating (170V - 250V).

Cleaning & Maintenance

- Power plug must be disconnected before cleaning.
- Any stain or deposit on the cook-top surface must be cleaned off immediately before reusing.
- Cleaning must be done when cook-top surface has completely cooled down.
- To clean the cook-top, wipe with a dry cloth. If stain remains, clean with a moist sponge soaked with mild soap, and then wipe again with a moist cloth.
- To clean the body of induction cooker, wipe with a soft moist cloth. If stain remains, clean with a moist sponge soaked with mild soap, and then wipe with a moist cloth.
- Do not immerse induction cooker into water.
- Do not clean cook-top with any rough cloth or abrasive tool.
- Do not use organic solvents or any cleaning products that contain chemicals such as Benzene.

Note: Over time, cook-top panel may be discoloured due to one of the following situations. Operation of induction cooker would not be affected as this is normal.

- Overheating or burning empty cookware
- Spillage not cleaned immediately
- Cookware not clean
- Long period of usage

Troubleshooting

When you run into any problem operating this product, use the table below to troubleshoot the problem. If the problem persists, contact our Repairs & Customer Service Centre.

Phenomenon	Check-up Items	Solution
Power is connected and Main on/off switch is turned on, but the induction cooker does not respond when the on/off button is pressed.	<ul style="list-style-type: none"> • Is there a power shortage in your area? • Is there a short circuit in the power source of your home? • Is the power plug too loose or not connected well? 	<ul style="list-style-type: none"> • Try again after power supply resumes. • Find out the cause of short circuit and eliminate it before switching on the cooker again. • Re-connect the plug or replace the power jack.
Buzzer beeps continuously and pan is not heated.	<ul style="list-style-type: none"> • Is the pan not suitable for induction cooking? • Is the pan positioned properly? 	<ul style="list-style-type: none"> • Use an appropriate pan. • Position the pan in the centre of cook-top.
Induction cooker stops heating during normal operations.	<ul style="list-style-type: none"> • Is the pan empty or cooking temperature too high? • Are the air inlet and outlet being blocked? • Is the surrounding temperature too high? 	<ul style="list-style-type: none"> • Avoid operating cooker with an empty pan. Let cooker cool down before switching it on again. • Remove obstruction from the vent. Let induction cooker cool down and try again. • Try again after the room cools down.
Temperature fluctuates.	<ul style="list-style-type: none"> • Is pan bottom not flat? 	<ul style="list-style-type: none"> • Replace pan with a flat-bottomed one.

- Above table enlists the most common problems regarding the operations of the product and their possible causes as well as suggested solutions. It is strictly for users' reference only.
- Should there be any product malfunction or breakdown, DO NOT repair it yourself. Contact our Repairs & Customer Service Centre or consult a licensed technician immediately.

Technical Specifications

Model	GIC-CS28B-S
Voltage	220 - 240 V
Frequency	50 / 60 Hz
Rated Power Output (Max)	2,800 W
Number of Cooking Hob	1
Maximum Output of Cooking Hob	2,800 W
Dimensions	(H) 66mm (W) 305mm (D) 505mm (without feet)
	(H) 95mm (W) 305mm (D) 505mm (with feet)
Cutout Dimensions	(H) \geq 316 (W) 267mm (D) 465mm
Net Weight	Approx. 5.6 kg
Gross Weight	Approx. 7.2 kg
Power Adjustment Range	300 W - 2,800 W

Specifications are subject to change without prior notice.

If there is any inconsistency or ambiguity between the English version and the Chinese version, the Chinese version shall prevail.

Refer to www.germanpool.com for the most up-to-date version of the Operating Instructions.

目錄

注意事項	12
產品結構	13
安裝說明	14
使用說明	15
清潔及維護	17
故障檢修	17
技術規格	18
保用條款	19

注意事項

△ 警告：

- 如果器具面（面板）有破裂，必需關閉電器電源，以避免觸電的可能性。
 - 刀、叉、勺和蓋等金屬物品不應該放在電磁爐上，因為他們會變熱。
 - 本設備擬用於僅在室內的家居。
 - 此產品不可通過外部計時器或單獨的遠端控制系統操作。
 - 設備運行時，可觸及表面的溫度可能很高。
 - 如果電源軟線損壞，為避免危險，必須由製造廠或其維修部或類似的專職人員來更換。
-
- 當電磁爐開機後，若用戶沒有按鍵任何操作，機器會在1小時45分到2小時15分鐘內自動停止加熱，進入待機狀態；保證機器安全。
 - 請單獨使用13A以上的插座，切勿使用萬用插座或與其他電器共用插座。
 - 請勿用水直接沖洗電磁爐，以免破壞電器絕緣性能。
 - 請勿於排氣口及吸氣口插入鐵絲、金屬等物件，以免發生觸電危險。
 - 切勿讓鍋具猛烈撞擊玻璃面板。
 - 電磁爐水平放置後，側面及背面距離牆壁必須預留最少 10cm 或以上，切勿堵塞出風口及入風口、將爐身鑲嵌或密封。
 - 請勿將電磁爐放置在煤氣爐、煤油爐等熱源附近使用。
 - 請勿將鐵片或其他鐵磁性材料直接放在玻璃面板上加熱，避免因高溫而產生灼傷危險。
 - 空鍋具請勿加熱過久，以免發生危險，鍋具溫度過高時，電磁爐會自動停止加熱。
 - 切勿加熱罐頭等密封的東西，否則會因罐頭內氣體受熱膨脹導致爆炸。
 - 長期不使用電磁爐時，請將電源插頭由插座拔出。
 - 身體、感知或精神能力有缺陷或無法獲得經驗和學習知識的人員（包括兒童）必須在負責其安全的人員監督下或瞭解如何使用本設備後方可使用。
 - 嚴密看管兒童，防止他們把玩此設備。
 - 不能使用蒸汽清潔器。
 - 使用後，應通過「電源開關」鍵  關掉電磁爐
 - 家庭使用的器具和在下列場所使用的器具應有相關說明：
 - 商店，辦公室和其他工作環境的廚房區域；
 - 農家；
 - 旅館，汽車旅館和其他住宿環境裡給客人使用的。

產品結構

外型

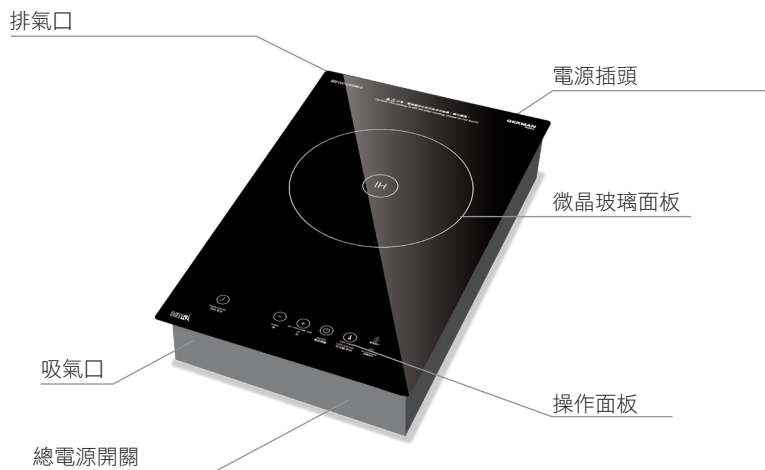

控制面板

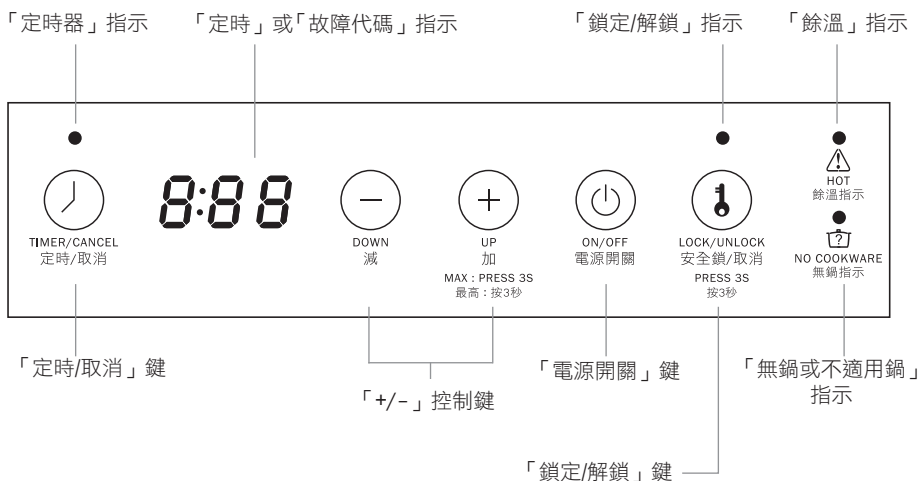

安裝說明

△ 安裝前注意

- 嵌入式電磁爐周圍不應有任何障礙物阻擋機身，以免影響電磁爐的散熱效能。
- 請確保電源插頭設在方便接插的地方，並必須接上地線。

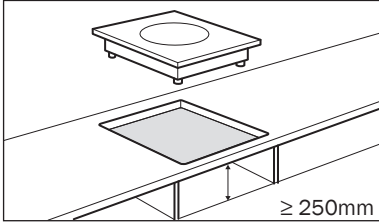

1. 安裝時，注意機身底部以下必須預留不 $\geq 250\text{mm}$ 高的空間排風。

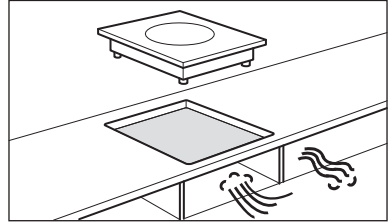

2. 機身底部進出風口不能設在封閉的空間裡，必須保持與不同空間的空氣連接，並盡量與房間裡的空氣保持一定程度的連接。

安裝程序

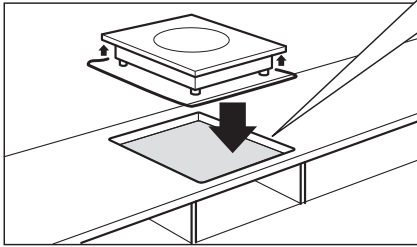

1. 依據參考開孔尺寸 $\geq 267\text{mm}(W) \times \geq 465\text{mm}(D)$ ，在廚櫃檯面開孔。
2. 將隨機的耐油橡膠貼於玻璃支架底部的黏貼處，然後將機身嵌入櫃中。
3. 插上電源，安裝完畢。

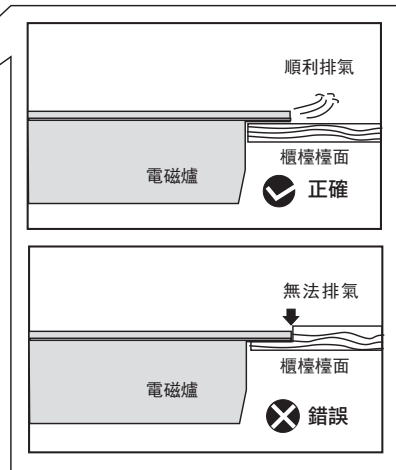

注意：安裝時必須確保後排氣口高於檯面，使之能正常出風（如上圖所示）

使用說明

鍋具

請使用德國寶電磁爐專用或認可之鍋具，盡量不要選用其他替代品，以免性能受影響。

適用的各類鍋具

- 材質：鐵、鑄鐵或導磁不銹鋼。
- 形狀：底部直徑12cm以上之平底鍋。鍋具底部直徑不宜超過25cm，鍋具加上食物的重量不宜超過6kg。



磁性不銹鋼壺



鐵製煎鍋



磁性不銹鋼鍋



鐵製彩色鍋



磁性鐵製珐瑯壺



鐵板/鑄鍋

不適用的各類鍋具

- 材質：非鐵質金屬、陶瓷、玻璃及以鋁、銅為底的鍋具。
- 形狀：底部凹凸差距過大的，底部直徑小於8cm。



鋁製水壺



耐熱玻璃鍋



陶瓷鍋



底部凹凸不平



鍋底附腳



鍋底直徑過小

按鍵說明

「電源開關」鍵 

在休眠狀態下，按此鍵進入待機狀態；再按此鍵一次可轉回休眠狀態。

「定時」鍵 

電磁爐在加熱狀態下，按此鍵可使機器進入定時加熱狀態；電磁爐在定時加熱狀態下，按此鍵可取消定時，而電磁爐會繼續以之前所調校的功率加熱。

「+/-」控制鍵 

電磁爐在加熱和定時加熱狀態下，按「+」鍵或「-」鍵可使機器上下調節加熱功率；在按「定時/取消」鍵後的5秒鐘內，按「+」鍵或「-」鍵可使機器上下調節加熱時間。

「鎖定/解鎖」鍵 

電磁爐在工作狀態下，按此鍵可使機器進入鎖定狀態，此時，除按「電源開關」鍵以外，其他任何按鍵操作無效；電磁爐在鎖定狀態下，長按此鍵3秒可使機器進入解鎖狀態，此時，所有按鍵操作有效。

使用說明

操作程序

1. 將電磁爐插頭插入插座，開啟總電源開關，機器鳴響一聲，表示電磁爐已進入待機狀態，如30秒內無操作則進入休眠狀態（所有指示燈熄滅）。
2. 待機狀態下，將合適的鍋具放置於環形加熱區內按「+/-」鍵進入加熱狀態，此時環形指示燈長亮，數碼管顯示默認火力3擋。再按「電源開關」一次則停止加熱，轉回休眠狀態。
3. 電磁爐在加熱狀態時，可使用「+/-」鍵調節火力大小。各擋位數碼管對應顯示「H1 — H9」最高檔顯示「HH」。當從「H9」升高到「HH」擋時，需長按「+」鍵3秒鐘。
4. 電磁爐對不適合加熱的鍋具會自動識別，進而限制加熱火力，此時按「+」鍵將不能升高火力擋位，且「無鍋或不適用鍋指示燈」及「數碼管顯示E1」會閃爍30秒以提示用戶。
5. 電磁爐在加熱狀態時，可使用「定時」鍵使機器進入定時加熱狀態，按鍵後5秒內，「定時指示燈」閃爍，同時顯示「0：30」並閃爍。此時，可使用「+/-」鍵調節加熱時長（1分~9小時59分），每短按一次增減1分鐘，持續長按則機器自動加長至10分鐘增減變化。當設定操作完畢5秒後，「定時指示燈」及時間顯示由閃爍轉為長亮，此時定時操作確定。
6. 電磁爐在定時加熱狀態時，再長按3秒「定時」鍵可退出定時功能。
7. 電磁爐在工作狀態時，可使用「鎖定/解鎖」鍵使機器進入鎖定狀態；電磁爐在鎖定狀態時，可長按「鎖定/解鎖」鍵3秒使機器進入解鎖狀態。
8. 電磁爐在工作狀態時，可使用「電源開關」鍵使機器停止工作，進入休眠狀態。
9. 電磁爐在下列情況下會自動退出加熱狀態進入待機狀態：
 - (加熱狀態時) 加熱區內持續沒有放置合適鍋具達30秒
 - (加熱狀態時) 無任何按鍵操作達120分鐘
 - 其他異常情況進入保護狀態。待機狀態如30秒內無操作則進入休眠狀態。
10. 電磁爐使用完畢後，關閉總電源開關。

故障代碼及說明

故障代碼	故障說明	故障代碼	故障說明
E0	電路故障	E4	低壓
E1	無鍋或鍋具不合適	E5	主傳感器開短路保護
E2	IGBT過熱保障	E6	IGBT傳感器開短路保護
E3	高壓	E7	乾燒保護

· E3及E4不屬於機器故障，待電壓恢復後（170V - 250V）即可使用。

清潔及維護

- 清潔前必須先拔下電源插頭。
- 任何污垢必須即時清理。
- 必須待爐面完全冷卻才進行清潔。
- 清潔面板時，先以扭乾的濕布擦拭；若仍未能除掉污漬，可用中性去污粉或洗潔精擦拭，然後再用濕布擦拭即可。
- 清潔電磁爐機身時，先用柔軟濕布擦；若有油污難以清除時，用中性洗潔精擦拭後再用濕布擦拭乾淨。
- 切勿用水直接沖洗或將機身浸入水中清洗。
- 切勿使用堅硬之刷子刷洗爐面。
- 切勿使用有機溶劑或苯等化學藥品擦拭電磁爐。

注意：以下幾種情況會造成玻璃面板變色，實屬正常，不會影響電磁爐正常使用：

- 加熱乾燒時
- 加熱湯水外溢未能及時擦淨
- 使用不潔淨底部鍋具加熱時
- 長時間使用

故障檢修

使用中如發現電磁爐操作上有問題，在送回本公司維修前請先依照下表進行檢查：

故障現象	檢查要點	處理方法
接通電源，按機底電源總開關，再按「開/關」鍵，電磁爐無反應。	<ul style="list-style-type: none">• 是否停電?• 府上的自動開關或保險絲是否發生短路?• 插頭是否脫落或接觸不良?	<ul style="list-style-type: none">• 電源恢復後再使用。• 檢查短路原因，排險後才使用。• 插牢或更換插孔後使用。
蜂鳴器斷續鳴響且鍋具不加熱。	<ul style="list-style-type: none">• 鍋具不適應?• 鍋具位置不合適?	<ul style="list-style-type: none">• 使用電磁爐適用之鍋具。• 將鍋具放置在電磁爐面板中心。
在正常運作時停止加熱。	<ul style="list-style-type: none">• 是否空鍋或溫度過高?• 吸氣口或排氣口是否堵塞?• 室溫太高?	<ul style="list-style-type: none">• 防止乾燒，降溫後自動繼續。• 待機件冷卻後才使用，並注意保持內部通風。• 室溫降低後才使用。
保溫失控。	<ul style="list-style-type: none">• 鍋底是否凹凸不平?	<ul style="list-style-type: none">• 更換平底鍋具後使用。

- 以上為常見故障的判斷與檢查，只供用戶作參考之用。
- 如遇故障切勿自行修理，避免發生危險及對機件造成損害；請立即找專業技術人員或聯絡本公司作出適當維修。

技術規格

型號	GIC-CS28B-S
電壓	220 - 240 V
頻率	50 / 60 Hz
額定總功率 (最大)	2,800 W
爐頭數目	1
爐頭最大功率	2,800 W
機身尺寸	(H) 66mm (W) 305mm (D) 505mm (不連腳)
	(H) 95mm (W) 305mm (D) 505mm (連腳)
開孔尺寸	(H) ≥ 316 (W) 267mm (D) 465mm
淨重	約 Approx. 5.6 kg
總重	約 Approx. 7.2 kg
功率調校範圍	300 W - 2,800 W

產品規格及設計如有變更，恕不另行通知。

中英文版本如有出入，一概以中文版為準。

本產品使用說明書以 www.germanpool.com 網上版為最新版本。

保用條款

此保用提供德國寶產品之機件在正常使用下壹年保用 (自購買日起計算)。

Warranty Terms & Conditions

Under normal operations, the product will guarantee a 1-year full warranty provided by German Pool (effective from the date of purchase).

* 貴戶須在購機十天內，以下列其中一種方式向本公司登記資料，保用手續方正式生效：

- 1) 填妥德國寶VIP手機應用程式保用登記表 (掃描右方二維碼)
- 2) 填妥本公司網頁保用登記表
www.germanpool.com/warranty
- 3) 填妥保用卡郵寄至本公司。



* This warranty is not valid until customer registration information is received by our Service Centre within 10 days of purchase via one of the following means:

- 1) Visit our VIP App and register online:
(Scan the QR Code on the right)
- 2) Visit our website and register online:
www.germanpool.com/warranty
- 3) Complete the attached Warranty Card and mail it back to our Customer Service Centre.



另請填妥以下表格並與正本發票一併保存，以便維修時核對資料。用戶提供之所有資料必須正確無誤，否則免費保用將會無效。 Please fill out the form below. This information and the original purchase invoice will be required for any repairs. Warranty will be invalidated if information provided is found to be inaccurate.

型號 Model No. : GIC-CS28B-S

機身號碼 Serial No. : _____ 發票號碼 Invoice No. : _____

購買商號 Purchased From : _____ 購買日期 Purchase Date : _____

1. 未能出示購買發票正本者，將不獲免費維修服務。
2. 用戶應依照說明書的指示操作。本保用並不包括：
 - 上門安裝、檢驗、維修或更換零件之人工以及一切運輸費用；
 - 因天然與人為意外造成的損壞 (包括運輸及其他)；
 - 電源接合不當、不依說明書而錯誤或疏忽使用本機所引致之損壞。
3. 於下列情況下，用戶之保用資格將被取消：
 - 購買發票有任何非認可之刪改；
 - 產品被用作商業或工業用途；
 - 產品經非認可之技術人員改裝或加裝任何配件；
 - 機身編號被擅自塗改、破壞或刪除。
4. 總代理有權選擇維修或更換配件或其損壞部份。
5. 產品一經被轉讓，其保用即被視作無效。

1. Customer who fails to present original purchase invoice will not be eligible for free warranty service.
2. Customer should always follow the operating instructions. This warranty does not apply to:
 - labour costs for on-site installation, check-up, repair, replacement of parts and other transportation costs;
 - damages caused by accidents of any kind (including material transfer and others);
 - operating failures resulting from applying incorrect voltage, improper usage, and unauthorized installations or repairs.
3. This warranty is invalid if:
 - the purchase invoice is modified by an unauthorized party;
 - the product is used for any commercial or industrial purposes;
 - the product is repaired or modified by unauthorized personnel, or unauthorized parts are installed;
 - the serial number is modified, damaged or removed from the product.
4. German Pool will, at its discretion, repair or replace any defective part.
5. This warranty will be void if there is any transfer of ownership from the original purchaser.

客戶服務及維修中心

中國香港

九龍大業街59號

三湘九龍灣貨運中心地下B室

電話：+852 2773 2888

傳真：+852 2356 9798

電郵：repairs@germanpool.com

中國澳門

澳門青洲大馬路(青洲新路)

515號美居廣場第二期1樓A座

電話：+853 2875 2699

傳真：+853 2875 2661

Customer Service & Repair Centre

Hong Kong, China

Unit B, G/F, Sunshine Kowloon Bay

Cargo Centre, 59 Tai Yip Street,

Kowloon, Hong Kong

Tel : +852 2773 2888

Fax : +852 2356 9798

Email : repairs@germanpool.com

Macau, China

A, 1 Andar, Mei Kui Kuong Cheong Fase 2,

No.515 Avenida Do Conselheiro Borja

Macau

Tel : +853 2875 2699

Fax : +853 2875 2661

此保用只適用於香港及澳門

This warranty is valid only in Hong Kong and Macau

German Pool (Hong Kong) Limited

Hong Kong, China

Room 113, Newport Centre Phase II, 116 Ma Tau
Kok Road, Tokwanan, Kowloon, Hong Kong.
Tel: +852 2773 2888
Fax: +852 2765 8215

Mainland, China

8th, Xinxiang Road, Wusha Industrial Park,
Daliang, Shunde, Foshan, Guangdong
Tel: +86 757 2219 6888
Fax: +86 757 2219 6809

Macau, China

A, 1 Andar, Mei Kui Kuong Cheong Fase 2,
No.515 Avenida Do Conselheiro Borja, Macau
Tel: +853 2875 2699
Fax: +853 2875 2661



香港《S MARK》
安全認證



中國櫥櫃/家電行業
十大影響力品牌



CEO非凡品牌大賞



香港優質商標



香港工商業獎



2007
最具價值
創星品牌企業獎



香港中小企業
最佳拍攝大獎



香港消費者推祟品牌



香港《心博》
優質服務證書



香港名牌十年成就獎
HONG KONG TOP BRAND TEN YEAR
ACHIEVEMENT AWARD

©All rights reserved. Copying, reproducing or using the contents of this manual is not allowed without prior authorization from German Pool, violators will be prosecuted.