

WiFi Smart Built-in
Induction & Ceramic Hybrid Cooker

GIH-PD50B-SC



Online Warranty Registration



Please read these instructions and warranty information carefully before use and keep them handy for future reference.

USER MANUAL

請即進行保用登記！
有關保用條款細則，請看說明書最後一頁。

Please register your warranty information now !
For Warranty Terms & Conditions,
please refer to the last page of this user manual.

Table of Contents

Warnings & Safety Precautions 04

Installation Instructions 07

Product Structure 08

Operation Guidelines 09

Operation Instructions 10

Cleaning & Maintenance 18

Troubleshooting 19

Technical Specification 20

Warranty Terms & Conditions 39

Warnings & Safety Precautions

WARNING!

Read all instructions carefully before using this product.

- This product is for domestic indoor use only. If this product is used for any commercial, industrial, rental or other purposes, product warranty will be VOIDED.
- This product is not intended for use by children or persons with reduced physical, sensory or mental capabilities, or lack of experience and knowledge, unless they have been given supervision or instruction concerning use of this product by an adult responsible for their safety.
- Mind your children and DO NOT let children play with this product.
- Cleaning and user maintenance shall not be made by children without supervision.
- Check the voltage indicated on the rating label before using this product.
- If the supply cord is damaged, it must be replaced by the manufacturer, its service agent or similarly qualified persons in order to avoid hazards.
- Unplug this product from the power source before cleaning and maintenance.
- Contact German Pool authorized service technician for repair or maintenance of this product.

User Safety

- Use of this product is strictly prohibited by children or persons with reduced physical, sensory or mental capabilities, or lack of experience and knowledge.
- Mind your infants and small children, DO NOT let children play with this product. To prevent harm, children and persons with reduced mental capabilities are strictly forbidden to use this product.
- The heating zones of this product may remain hot after use, and the hot cooktop will display “H” indicating hot surface. To avoid getting burnt, DO NOT touch.
- During use of this product, if the glass ceramic is accidentally cracked or damaged, stop using immediately to avoid risk of electric shock.
- Take extra care when using or storing the temperature probe to avoid getting pricked by the sharp metallic parts. The temperature probe has a built-in battery, DO NOT place the probe near flame or high heat. Improper use may damage the probe.

Restrictions Of Use

- DO NOT place this product on an uneven surface, or near water, flame or heat source (this product must be placed at least 30cm away from flame or heat source).
- DO NOT place this product near devices that are susceptible to moisture and electromagnetic interference.
- DO NOT use unprofessional cookware to avoid affecting this product's heating performance or causing danger.
- If using other cookware, they must contain iron materials, the utensil must have a flat bottom, and with a diameter not larger than the heating area.
- Before heating the cookware, make sure the utensil has “food” inside. DO NOT heat an empty dry utensil.
- Beware metal handle of utensil will become hot and may cause scalding.
- Use only correct cookware with the induction cooktop. The cookware must be made of ferromagnetic material (iron or stainless steel alloy containing iron). Infrared ceramic cooktop can be used with all cookware.

Warnings & Safety Precautions

Safety Precautions Regarding Power

- DO NOT use any power source other than AC 220V to avoid fire and electric shock.
- When unplugging from the socket, hold by the plug, DO NOT tug on the power cord, in order to avoid electric shock and short circuit leading to a fire.
- DO NOT let children operate this product by themselves, and place this product out of reach of infants and young children, in order to avoid electric shock, burns or other hazards.
- DO NOT plug or unplug this product with wet hands in order to avoid electric shock or injury.
- Use only power socket with rated voltage of 13A or above, and DO NOT share socket with other appliances.
- DO NOT operate this product by means of an external timer or remote control system.
- If the power cord is damaged, to avoid hazards, it must be replaced by the manufacturer, its repair department or similar department in order to avoid hazards.

Precautions Regarding Installation

- When this product is in use, it must be kept at least 10cm away from walls and furniture, as heat may cause damage, discoloration and disfiguration to surrounding walls and furniture.
- DO NOT use this product directly on a metal counter, to avoid causing the metal surface to become hot and causing hazards.
- When this product is in use, care must be taken to maintain ventilation to ensure adequate heat dissipation.

Precautions When Product Is In Use

- DO NOT heat sealed containers or sealed foods (such as canned food, pressure cooker, etc.) directly on this product, to avoid the container expanding and causing hazards.
- DO NOT allow foreign substances to block this product's air inlet and air outlet, to avoid parts becoming overheated and affecting product performance.
- When this product is in use, DO NOT leave metal objects (such as knives, forks, spoons, lids) on this product's surface as they may become hot.
- Inspect this product's air inlet and air outlet regularly to make sure they are not blocked.
- The surface of this product may remain hot after use, DO NOT touch to avoid getting burns.
- If this product shows abnormality or malfunction, disconnect the power source immediately, and unplug from the power cord. Allow the product to cool down completely then take it to a professional for repair.

Cleaning & Maintenance

- Make sure to turn off this product's power supply and allow the product surface to cool down completely before commencing cleaning.
- DO NOT pour water on this product or immerse this product in water.

Warnings & Safety Precautions

- DO NOT use water to wash this product's air inlet/outlet.
- DO NOT allow water or foreign substance to enter this product's body. Keep this product clean at all times.
- DO NOT use steam cleaner or hard objects like scourge pad to clean this product.
- Grease on the glass ceramic should be cleaned with a soft cloth moistened with neutral dish detergent. DO NOT use bleach or corrosive liquids to clean this product.
- Air inlet/outlet may be wiped with a soft dry cloth. When removing dust, please use a soft brush or mini vacuum cleaner.
- After cleaning, wipe this product with a soft dry cloth to remove all traces of moisture.
- If this product will not be used in an extended period of time, please disconnect the power source, and protect this product from humidity, dust and bugs.

Other Safety Precautions

- DO NOT allow this product to sustain strong impact, heavy pressure or scratch it with sharp objects in order to avoid damage or malfunction.
- ⚠ **WARNING!** If the glass ceramic is cracked, turn off this product immediately to avoid the possibility of electric shock.
- DO NOT retrofit, dismantle or repair this product by yourself in order to avoid fire hazards, electric shock or burns. Repair work must be done by professional technician only.
- In case of malfunction or product failure, stop using this product immediately, in order to avoid fire hazards, electric shock or burns. For example, if the power cord or plug becomes abnormally hot during use; if this product emits smoke or burnt smell; if any part of this product becomes broken, loose or emits strange noise; or if you detect other abnormalities or malfunctions.

Note:

When this product is heating, keep all heating zones dry and free from moisture or impurities.

Installation Instructions

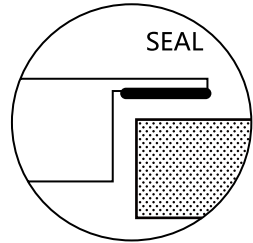
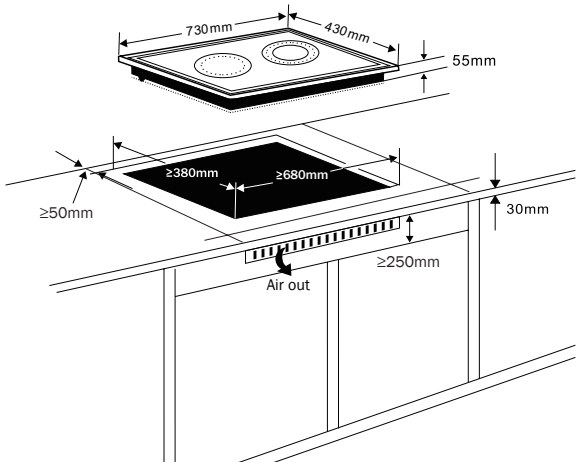

Use the seal strip to fix the cooktop on the counter so as to keep it level.

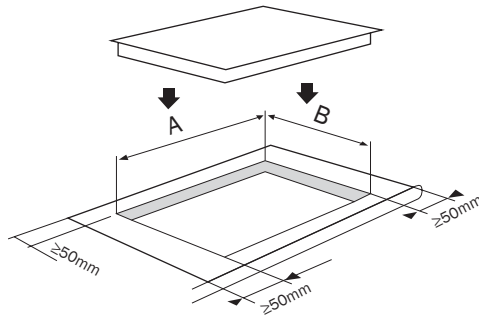

1. Leave at least 50mm space on all sides of the cutout cavity (see diagram above). The countertop should be at least 30mm thick to avoid high temperature causing the countertop to deform.
2. Good ventilation should be observed on all sides of the product, and the air inlet and air outlet must not be blocked. Leave at least a height of 250mm free space under the product to ensure adequate ventilation.
3. The air inlet and air outlet under the product body must not be enclosed in a sealed space in order to allow adequate air exchange, and to maintain a certain degree of connection with the air in the room.

Product Structure

Main Body

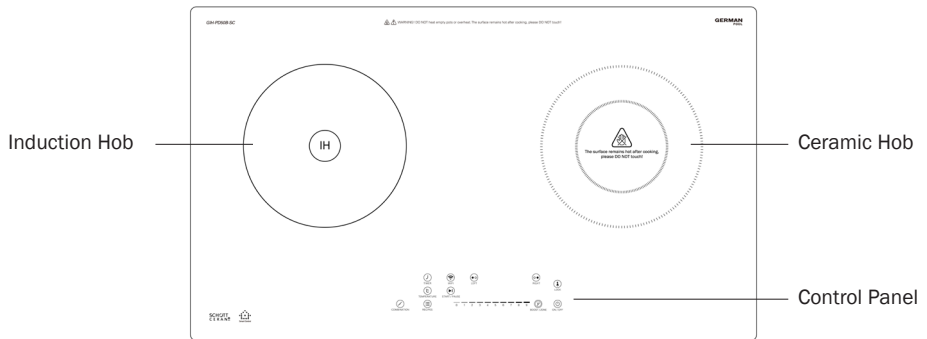

Temperature Probe

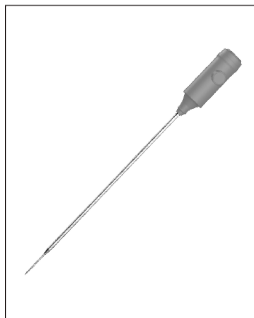

Temperature Probe

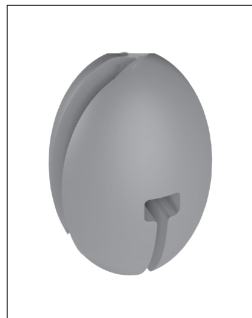

Silicone Stand



Charger

Operation Guidelines

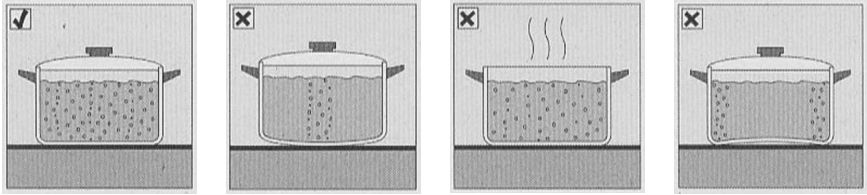

- Choose a suitably sized pot or pan with a flat bottom.
- To conserve energy, it is recommended to cover the cookware with a lid.
- The base of the cookware should be at least the size of the cooking zone.
- The diameter of the cooking zone is 12-26cm.
- If the size of the bottom of the cookware is same as that of the cooking zone, it ensures best heat transfer. When purchasing cookware, please remember that the opening diameter marked by the manufacturer is larger than the size of the bottom.
- DO NOT heat an empty cookware.
- Please read the instruction manual provided by the cookware manufacturer.

Cookware Selection For Induction Hob



- DO NOT use cookware with uneven or curved base.

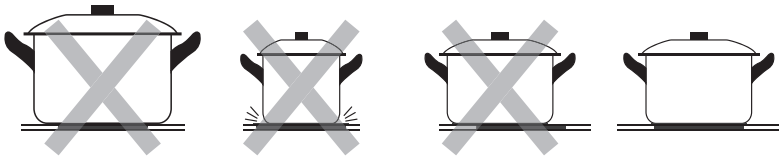

- Make sure the base of the cookware pan is smooth, sits flat against the glass ceramic, and is the same size as the induction cooking zone. Use only cookware with a diameter as large as the marked cooking zone. Using a slightly wider cookware will maximize energy efficiency, while using a slightly smaller cookware will decrease efficiency.

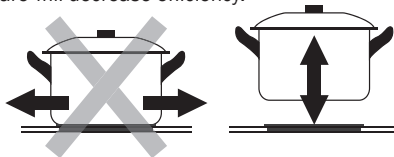







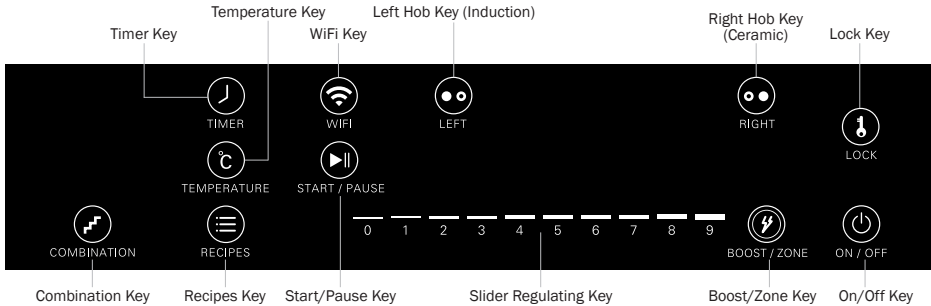





- When moving your cookware, please lift it completely off the cooktop; DO NOT drag it across the surface to avoid scratching the glass ceramic.

Operation Instructions

Control Panel











Key	Function
 ON / OFF	On/Off Key Tap this key to turn product on or off
 LOCK	Lock Key <ul style="list-style-type: none"> • Tap this key to activate or deactivate Lock Function • When Lock Function is activated, all keys become inoperable
 LEFT	Left Hob Key (Induction) Tap this key to activate the left hob (induction cooker)
 RIGHT	Right Hob Key (Ceramic) Tap this key to activate the right hob (ceramic cooker)
	Slider Regulating Key Slide or tap along the slider to adjust power level, time, temperature, etc.
 BOOST / ZONE	Boost/Zone Key <ul style="list-style-type: none"> • When using the left hob (induction cooker), tap this key to instantly boost to maximum power • When using the right hob (ceramic cooker), tap this key to switch among single inner, single outer or dual heating zones
 START / PAUSE	Start/Pause Key During cooking, tap this key to pause heating, and tap again to resume heating
 TIMER	Timer Key <ul style="list-style-type: none"> • During cooking, tap this key to set off-timer • When using Recipes Function, tap this key to set on-timer. See “C. Recipes Function” for details
 RECIPES	Recipes Key <ul style="list-style-type: none"> • Tap this key to set or use recipe, or record cooking steps and save as recipe. See “C. Recipes Function” for details • Save up to a maximum of 9 recipes
 COMBINATION	Combination Key When using Recipes Function, tap this key to save or edit a recipe. See “C. Recipes Function” for details
 TEMPERATURE	Temperature Key Tap this key to activate Temperature Control Function. For details, see “B. Temperature Probe & Temperature Control Function”
 WIFI	WiFi Key Tap this key to activate WiFi connection. For details, see “D. Connecting With WiFi”



Operation Instructions

A. Basic Operation



Start Cooking

1. Connect power, tap On/Off Key  to turn on the product. Panels on both the left of Right Hob Key  and Left Hob Key  show "-". Product enters standby state.
2. Tap Left Hob Key  to select induction cooker, or tap Right Hob Key  to select ceramic cooker. Panel on the left of the selected hob will blink "O." signaling the hob is turned on.
3. Use the Slider Regulating Key to adjust the power level and start cooking: slide to the right to increase power level, slide to the left to decrease power level, or directly tap 0-9 to select level. During cooking, to adjust the power level, tap the corresponding Hob Key first, then use the Slider Regulating Key to adjust the power level.
4. During cooking, if user wishes to pause heating, tap the corresponding Hob Key first, then tap Start/Pause Key  to pause. Panel on the left of the selected hob will show "II." signaling the hob has paused heating. Tap Start/Pause Key  again to resume heating.
5. After cooking is finished, tap On/Off Key  to turn off the product.



Note:

- After turning on the product, user must first tap Left Hob Key  or Right Hob Key  to select hob before selecting other functions, otherwise the keys will not respond.
- When using the ceramic cooker, after the product has been turned off, panel to the left of Right Hob Key  will show "H", signaling the hob's surface temperature is > 60 °C, reminding user DO NOT TOUCH.



Ceramic Cooker - Switch Heat Zones

When cooking with the right hob (ceramic), if user wishes to switch between single and dual heating rings, tap Right Hob Key  first, then tap Boost/Zone Key  to switch rings.

Induction Cooker - Power Boost

When cooking with the left hob (induction), if user wishes to boost power level to the maximum, tap Left Hob Key  first, then tap Boost/Zone Key  and power level will instantly jump to the maximum (level 9).

Lock Function

1. When the product is turned on, tap and hold Lock Key  for 3 seconds to activate Lock Function. When Lock is activated, all keys become inoperable.
2. To deactivate Lock Function, tap and hold Lock Key  for 3 seconds again.

Operation Instructions

Timer

1. During cooking, tap Timer Key (⌚) to set the timer. Panel on the left of Timer Key blinks "00:00".
2. Tap the numbers on the Slider Regulating Key to set desired timer from 1 minute to 12 hours, eg.:
 - To set a timer for 50 minutes, tap 0-0-5-0
 - To set a timer for 5hr & 30min, tap 0-5-3-0
 - To set a timer for 11hr & 59min, tap 1-1-5-9

Note:

The maximum for the first digit is 1, indicating 10 hours. If user chooses 1 for the first digit, the maximum for the second digit will be 2, indicating 12 hours, and the third and fourth digits can only be zero, as the maximum time of the off-timer is 12 hours.

3. If the product does not receive any further command in 3 seconds, it will automatically confirm the current setting. Display will show timer countdown. When countdown time is up, the product will automatically stop cooking.
4. To alter timer duration, tap Timer Key (⌚) then enter new time. To cancel timer, enter 0-0-0-0.

Forced Shutdown Function

In standby state or during cooking, if there is water on the glass ceramic or when user taps and holds two or more keys simultaneously for more than 3 seconds, the product will automatically shut down for safety.

Induction Cooker - Dry Boil Protection

During use, when the hob's surface temperature exceeds 230°C, the induction cooker will stop heating. Panel on the left of Left Hob Key (●) will show "E2", buzzer will beep continuously in alarm. To continue cooking, user must let the product cool down first, then manually resume cooking.

Operation Instructions

B. Temperature Probe & Temperature Control Function

Temperature Probe







When the temperature probe is paired with the hob, user can read the real-time temperature of the food and control the cooking temperature. The temperature probe has a built-in li-ion battery, and must be charged before use:

1. Connect the temperature probe charger to USB power source.
2. Sit the temperature probe in to the charger. Battery indicator light on the temperature probe will blink signaling it is charging.
3. When all three indicator lights light up constant, it signals charging is complete.

WARNING!

- The temperature probe has a built-in battery, DO NOT place the probe near flame or high heat, or immerse the whole probe into water, to avoid damaging the probe.
- The temperature probe only works when there is food as medium. When using the temperature probe, there must be food or liquid in the cookware. DO NOT place probe in an empty cookware.

Controlled Temperature Cooking Function

1. Connect power, tap On/Off Key  to turn on the product. Panels on both the left of Right Hob Key  and Left Hob Key  show “-”. Product enters standby state.
2. Tap Left Hob Key  to select induction cooker, or tap Right Hob Key  to select ceramic cooker.
3. Tap Temperature Key  to set desired temperature. Panel to the left of Temperature Key  displays “000°C”. Tap the numbers on Slider Regulating Key to set temperature (max. 230°C), eg.:
 - To set temperature to 50°C, tap 0-5-0
 - To set temperature to 130°C, tap 1-3-0
 - To set temperature to 230°C, tap 2-3-0

Note:

The maximum for the first digit is 2, indicating 200°C. If user chooses 2 for the first digit, the maximum for the second digit is 3, indicating 230°C (the maximum settable temperature).

Operation Instructions

4. If the product does not receive any further command in 3 seconds, it will automatically confirm the current temperature setting. Panel will show “—”.
5. Secure the temperature probe onto the silicone stand, and clip the silicone stand onto the rim of the cookware. Make sure the tip of the temperature probe is inserted into the liquid or the food inside the cookware.
6. Press the button on the temperature probe one time to pair the probe with the hob. When pairing is successful, panel of the hob will indicate the real-time temperature of the food.
7. Hob will automatically start to cook, and will automatically adjust power level to maintain cooking at the set temperature.

Note:

- If pairing is unsuccessful, press button on the temperature probe to pair again.
- Please clean the temperature probe thoroughly before use, and make sure the probe is fully charged to avoid battery running out in the middle of cooking.

Operation Instructions

C. Recipes Function

Preset Recipes

This product comes with 9 factory default preset recipes (can be used by both induction hob and ceramic hob; power, time).

Recipe Number	Name	Ingredients	Steps	Power Level	Temperature	Time
1	Rice	Rice & water	1		60 °C	0:20:00
			2		85 °C	0:05:00
			3		99 °C	0:05:00
			4	2		0:05:00
			5		60 °C	1:00:00
2	Boil	Water	1		99 °C	0:00:30
3	Steam		1		99 °C	0:00:30
			2	4		0:20:00
4	Congee	Rice & Water	1		95 °C	0:30:00
			2	1		1:00:00
5	Ferment		1		50 °C	1:00:00
			2		53 °C	1:00:00
			3		55 °C	1:00:00
6	Keep Warm		1		60 °C	1:00:00
			2		60 °C	1:00:00
			3		60 °C	1:00:00
7	70 °C Sous Vide		1		70 °C	1:00:00
			2		70 °C	1:00:00
			3		70 °C	1:00:00
8	80 °C Slow Cook		1		80 °C	1:00:00
			2		80 °C	1:00:00
			3		80 °C	1:00:00
9	90 °C Slow Cook		1		90 °C	1:00:00
			2		90 °C	1:00:00
			3		90 °C	1:00:00













Note:

When user manually saves a recipe, that recipe number's default recipe will be overwritten and deleted.



Operation Instructions

Saving Recipes Manually









This product can store up to 9 recipes (for use by both induction hob and ceramic hob), and each recipe can be freely set with up to 9 steps, including power level, time, etc.

1. Connect power, tap On/Off Key  to turn on the product. Panels on both the left of Right Hob Key  and Left Hob Key  show “-”. Product enters standby state.
2. Tap Left Hob Key  to select induction cooker, or tap Right Hob Key  to select ceramic cooker.
3. Tap Recipes Key , then tap any number between 1-9 on the Slider Regulating Key to decide which number you would like to save this recipe as. Your selected number will show up on the left of the hob.
4. Tap Combination Key . Panel on the left of Combination Key will show “1”, indicating step 1. Set your desired time, temperature and power level:
 - Tap Timer Key  to set cooking time (1min “00:01” - 99min59sec “99:59”);
 - Tap Temperature Key  to set cooking temperature (max. 230 °C);
 - Tap Hob Key then adjust to your desired power level.
5. After setting is complete, tap Combination Key , then tap 2 on the Slider Regulating Key to set step 2. Repeat the above steps until sequence is done (max. 9 steps).
6. After all the steps has been set up, tap Combination Key , then tap and hold Recipes Key  for 3 seconds to save the recipe.

Note:



- When setting steps, the steps must follow numerical order from 1-9. DO NOT skip numbers (for example, skip to 9 directly after setting step 1) to avoid program errors.
- It is not necessary to set all 9 steps to save a recipe, simple set as many steps as you need, then tap Combination Key  then tap and hold Recipes Key  to save the recipe.
- To modify an existing recipe, please follow the steps in “Saving Recipes Manually” section to directly replace the old recipe.
- When a step involves using Temperature Control Function, the temperature probe must be paired with the hob first; and the hob will only start to countdown after the target temperature has been reached.

Saving Recipes By Cooking Record

1. Connect power, tap On/Off Key  to turn on the product. Panels on both the left of Right Hob Key  and Left Hob Key  show “-”. Product enters standby state.
2. Tap Left Hob Key  to select induction cooker, or tap Right Hob Key  to select ceramic cooker.
3. Tap Recipes Key , then tap 0 on the Slider Regulating Key. Panel to the left of Recipes Key  will show “0”, indicating the product is now in Cooking Record Mode.
4. Tap Start/Pause Key  to start recording. All steps including power-level adjustments,

Operation Instructions









temperature, start/pause will be recorded into the recipe (max. 9 steps). Number on the left of Combination Key will continue to increase with steps saved.

5. After cooking is finished, tap On/Off Key  to turn off heating. Panel on the left of Recipes Key  will blink "1".
6. To save this cooking record as recipe, tap a number on the Slider Regulating Key (number that you wish to set the recipe as), then tap and hold Recipes Key , and cooking record will be saved to the designated recipe.

Note:

After cooking, if you do not desire to save the cooking record, tap On/Off Key  again to turn off the product directly.

Using Saved Recipes

1. Connect power, tap On/Off Key  to turn on the product. Panels on both the left of Right Hob Key  and Left Hob Key  show "-". Product enters standby state.
2. Tap Left Hob Key  to select induction cooker, or tap Right Hob Key  to select ceramic cooker.
3. Tap Recipes Key  then tap the recipe's number on the Slider Regulating Key.
4. To set timer, tap Timer Key  then input countdown time by tapping the numbers on the Slider Regulating Key. If the product does not receive any further command in 3 seconds, it will automatically confirm the current setting, panel will display timer countdown. When countdown time is up, the product will automatically start cooking.
5. If user does not wish to set timer, tap Start/Pause Key  to directly start cooking.

Cleaning & Maintenance

WARNING!

- Before cleaning, turn off the power and wait until the cook-top surface has completely cooled down.
- If this product shows malfunction or needs maintenance or repair, disconnect from the power source and contact German Pool Customer Service & Repair Centre. Inspection and repair must be carried out by German Pool authorized technician only. DO NOT disassemble this product by yourself.

Note:

- DO NOT use rough cloth, scourge pad, steel wool or hard brush to clean this product to avoid scratching the glass ceramic.
- DO NOT use bleach, benzene, gasoline, thinner, corrosive chemical solvents or organic solvents to clean this product. DO NOT use steamer to clean this product.
- DO NOT immerse or splash product directly with water. DO NOT allow water or foreign matters to enter into product.
- DO NOT rinse this product's air inlet or air outlet with water.

1. For general cleaning, wiping with a dry soft cloth is sufficient.
2. Clean off any stain or food debris on the glass ceramic after each use. Wipe with a moist cloth, then wipe dry with dry soft cloth.
3. For stubborn stains, clean with a sponge moistened with diluted mild detergent, then wipe again with a moist soft cloth followed by a dry soft cloth.
4. Lightly wipe the air inlet/outlet with soft dry cloth. Use a soft brush or mini vacuum cleaner to clean off accumulated dust.
5. DO NOT rinse or immerse the temperature probe in water.
6. If product will not be used for an extended period of time, please unplug from the power source, and store the product away from humidity, dust and bugs.

Note:

Over time, glass ceramic cooktop panel may become discolored due to one or more of the following reasons: overheating or burning empty cookware; spillage not cleaned off in time; cookware bottom is unclean; long period of usage. It is a normal phenomenon, and will not affect operation of the product.

Troubleshooting

Problem	Possible Cause	Solution
Control Panel is unresponsive	Is the plug loose?	Make sure product is properly plugged in
	Has fuse or circuit breaker tripped?	Please have professional electrician check the fuse box
	Is the socket powered?	Make sure socket is powered
Cannot maintain temperature	Cookware has an uneven or curved base	Use cookware with a flat base
	Central thermostat failure. Does product show error code E2/E9?	Contact German Pool Customer Service & Repair Centre
Error Code U	Is the cookware appropriate for the hob?	Use appropriate cookware
	Is the cookware placed in the centre of the cooking zone?	Place cookware in the centre of the cooking zone
	Does the cookware have a base diameter smaller than 12cm?	Use cookware with a base diameter larger than 12cm
Product stops heating in the middle of cooking	Is the surrounding temperature too high?	This product must be used in a suitable temperature environment
	Is the air inlet or air outlet blocked? Is the fan turning?	Remove blockage; if fan still doesn't turn, contact German Pool Customer Service & Repair Centre
	Temperature Control Function is activated, and has reached target temperature	This is a normal phenomenon
	Induction cooker safety mechanism has activated	Wait 20 seconds or more, then restart product
Cannot connect to WiFi	Is your APP version up to date?	Please update latest App version
	Does your kitchen have a strong enough WiFi reception?	Strengthen your kitchen WiFi reception
Software cannot update	Is the cooktop in cooking progress?	During cooking process, the software cannot be updated. Please update software after cooking is finished
	Is your WiFi working?	Make sure your WiFi has a strong signal
Error Code E7	Voltage is higher than 260V, buzzer will sound alarm beep	When voltage returns to normal, buzzer will stop and product will resume operation
Error Code E8	Voltage is lower than 170V, buzzer will sound alarm beep	When voltage returns to normal, buzzer will stop and product will resume operation
Error Code E4	IGBT temperature short circuit, buzzer will sound alarm beep	Turn off the product manually, and contact German Pool Customer Service & Repair Centre
Error Code E2	Surface NTC sensor short circuit, buzzer will sound an alarm beep	Turn off the product manually, and contact German Pool Customer Service & Repair Centre
Error Code E3	IGBT temperature open circuit, buzzer will sound alarm beep	Turn off the product manually, wait until it has cooled down then restart. If problem persists, contact German Pool Customer Service & Repair Centre
Error Code E9	Surface NTC sensor open circuit, buzzer will sound an alarm beep	Turn off the product manually, wait until it has cooled down then restart. If problem persists, contact German Pool Customer Service & Repair Centre

Technical Specification

Model	GIH-PD50B-SC
Voltage	220-240 V
Frequency	50-60 Hz
Power	left: induction cooker 2,800W / right: ceramic cooker 2,200W
Electric Current	13A x 2
Product Dimensions	(H) 55 (W)730 (D)430 mm (without feet)
	(H) 72 (W)730 (D)430 mm (with feet)
Cutout Dimensions	(H) ≥305 (W)680 (D)380 mm
Net Weight	9.3 kg
Gross Weight	11.1 kg

- Specification is subject to change without prior notice.
- If there is any inconsistency or ambiguity between the English version and the Chinese version, the Chinese version shall prevail.
- Refer to www.germanpool.com for the most update version of the user manual.

請即進行保用登記！
有關保用條款細則，請看說明書最後一頁。

Please register your warranty information now !
For Warranty Terms & Conditions,
please refer to the last page of this user manual.

目錄

警告及注意事項 23

安裝說明 25

產品結構 26

使用前注意事項 27

使用說明 28

清潔與保養 35

故障檢修 36

技術規格 37

保用條款 39

警告及注意事項

⚠ 警告！

使用本產品前，請仔細閱讀所有說明。

- 本產品只限家居室內日常使用，如產品作任何商業、工業、出租或其他用途，保用證即告失效。
- 請勿讓兒童或身體有殘障、精神不健全及對本產品缺乏經驗或知識的人士單獨使用本產品；如需使用，必須要在負責任的成年人監管下方可使用。
- 應照顧好兒童，確保他們不會玩耍本產品。
- 無成年人監管下，勿讓兒童清潔及維護本產品。
- 使用前，請先檢查所有電壓是否與本產品標籤上的電壓相符。
- 如果電源線損壞，為免發生意外，電源線必須由廠方、廠方指定的維修中心或同等合格的技術人員進行更換。
- 清潔或檢查本產品前，必須先關機及拔掉插頭。
- 請聯繫德國寶授權的技術人員進行維修或保養本產品。

為保證使用安全，避免對您和他人造成傷害和財產損失，必須遵守以下安全事項：

使用注意

- 對於身體、感官或智力有缺陷，或經驗和知識有欠缺的人士（包括兒童），嚴禁使用本產品。
- 必須看管好嬰幼兒，嚴禁讓孩童玩耍本產品。孩子和智力障礙者嚴禁使用本產品，避免造成傷害。
- 使用後發熱區域會有餘溫，相應的爐頭顯示「H」指示，表示有高溫，嚴禁觸摸，否則會有燙傷的風險。
- 使用過程中如果無意中砸傷或使面板出現破損，必須立即停止使用，防止因漏電造成的電擊傷害。
- 溫度探針必須小心使用及妥善收納，防止金屬件鋒利傷人。溫度探針內有充電電池，嚴禁擺放在火源或高溫的地方，不當使用會損壞探針。

使用限制

- 嚴禁將本產品放置於不平衡、潮濕或靠近其他火源、熱源的地方（確保本產品與火源、熱源的距離至少30cm）。
- 嚴禁將本產品放置在容易受潮或電磁干擾的裝置附近。
- 嚴禁使用非專業鍋具，以避免影響加熱性能或產生危險。
- 如使用其他鍋具，必須遵守：鍋具底部平坦，直徑不大於加熱區。
- 加熱鍋具前，必須確保鍋內有「食物」，嚴禁空鍋乾燒。
- 使用金屬把手的鍋具必須注意防燙。
- 電磁爐頭必須使用正確的鍋具，僅限於導磁材質的鍋具（鐵鍋和含鐵不銹鋼鍋具），電陶爐頭可不限鍋具。

電源注意事項

- 嚴禁使用交流220V以外的電源，以避免造成火災觸電。
- 必須手持電源插頭部分拔下電源，以免造成觸電或短路起火。
- 嚴禁讓兒童單獨操作使用，本產品必須放在嬰幼兒不能觸及的地方，以避免觸電、燙傷等危險事故的發生。
- 嚴禁以濕的手接入或拔出電源接頭，以免造成觸電或受傷。

警告及注意事項

- 必須單獨使用額定電流13安以上的電源插座。
- 本產品不能在外接控制器或獨立的遙控控制系統下運行。
- 如果電源軟線損壞，為避免危險，必須由製造商、其維修部或類似部門的專業人員進行更換。

關於環境

- 因熱量會導致牆壁及家具受損、變色、變形，因此使用時必須距離牆壁和家具10cm以上。
- 嚴禁將本產品直接置於金屬台面上使用，以免產品對金屬台面進行加熱而發生危險。
- 使用時，必須注意保持通風，以保證散熱通暢。

使用中

- 嚴禁將密封容器或密封食品（如罐頭、高壓鍋等）直接置於產品上加熱，以免受熱膨脹發生意外。
- 嚴禁讓異物堵塞本產品進風口、出風口，以避免零部件過熱影響使用。
- 使用中嚴禁將金屬物體，如刀、叉、勺、蓋等放在本產品表面，因為它們可能變熱。
- 必須對進風口及出風口做定期檢查，以保證其不被阻塞。
- 本產品面板使用後餘有高溫，嚴禁觸碰，以免高溫燙傷。
- 如本產品發生異常或故障時，必須立即停止使用，並拔除電源線。在本產品冷卻後交由專業人員進行維修。

清潔保養

- 確保本產品已斷電，待本產品面板溫度冷卻再進行清潔。
- 嚴禁將本產品浸入水中或淋水。
- 本產品進風口及出風口嚴禁用水沖洗。
- 防止水、異物進入機體內，保證機體清潔。
- 嚴禁使用蒸氣清潔器或鋼絲球等硬質物品進行清潔。
- 面板油污請使用柔軟濕布沾中性清潔劑擦拭，嚴禁使用漂白水或含腐蝕性液體進行清潔。
- 進風口及出風口請使用柔軟乾布輕拭，清理灰塵時，請使用柔軟毛刷或微型吸塵器。
- 本產品清潔後請使用柔軟乾布進行清理，以確保乾燥。
- 長時間不使用本產品時，請將本產品斷電，並做好防潮、防塵、防蟲。

其他注意事項

- 嚴禁讓本產品承受大力衝擊或重壓以及銳器刻划，以免造成受傷或故障。
- ⚠ **警告！**如果面板表面有裂紋，立即關掉本產品以避免可能出現的電擊。
- 嚴禁改造本產品。非維修技術人員，不可拆卸修理，以免造成火災、觸電及燙傷。
- 發生異常或故障時，必須立即停止使用，以免造成火災、觸電及燙傷。例如出現下列情況：使用中電源線、電源插頭異常發熱；本產品有煙霧冒出、有燒焦的異味；本產品某部分發生裂開、鬆動或有異響；其他的異常或故障。

注意：

使用本產品加熱時，請保持加熱區乾燥，無水分雜質。

安裝說明

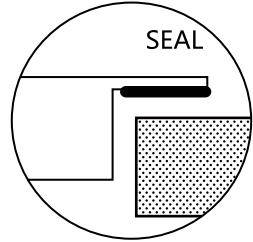
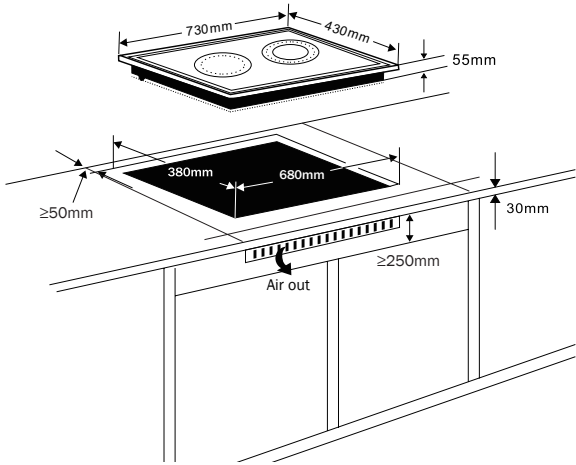

可使用海綿條固定在桌面上，以使爐身水平放好。

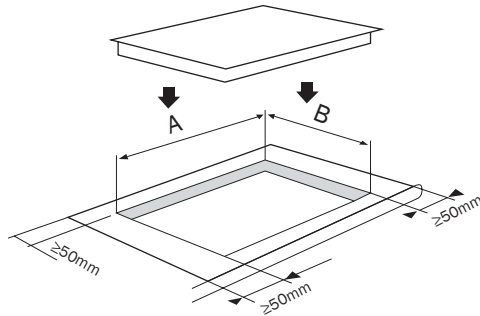

單位：mm

1. 開孔周圍必須預留至少50mm空間（參考上圖），工作台面應至少30mm厚，並由耐熱材料製成，以防因高溫導致桌面變形。
2. 本產品四周必須保持良好的通風，進風口和出風口不被阻塞；安裝時注意機身底部以下必須預留不少於250mm高的空間排風。
3. 機身底部進風口及出風口不能設在封閉的空間裡，必須保持與不同空間的空氣連接，並盡量與房間裡的空氣保持一定程度的連接。

產品結構

主機

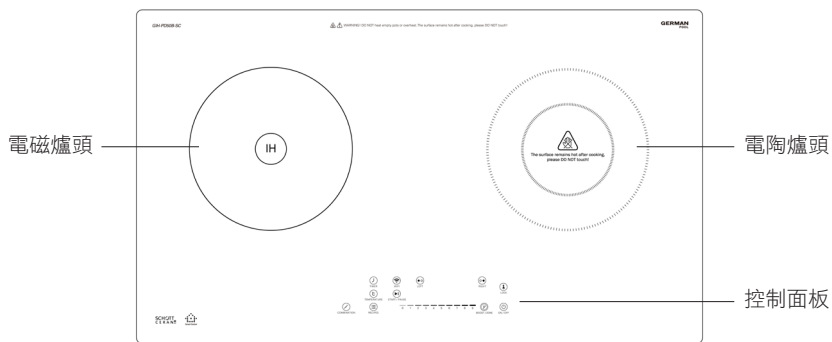

溫度探針

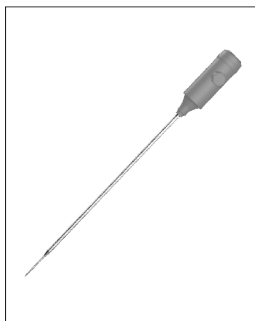

探針

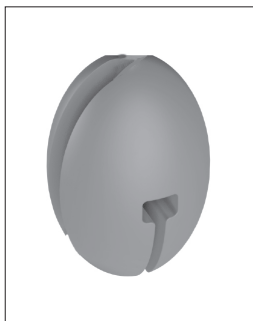

矽膠支架



充電座

使用前注意事項

電陶爐頭鍋具選擇

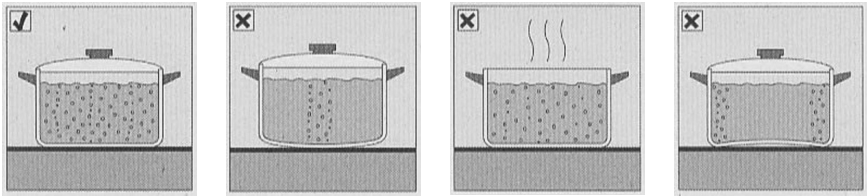

- 選擇合適容量的燉鍋及平底鍋處理食物。
- 若要達到節能效果，建議使用蓋子。
- 煮食鍋的底面積最起碼跟加熱區域同樣大小。
- 煮食區域的直徑為12cm-26cm不等。
- 如果煮食鍋的底面積和加熱面積一樣時，能夠達到最佳熱傳遞效果。當選購炊具時，請注意廠家標記的炊具的口徑比底面的直徑大。
- 禁止空燒鍋具。
- 請仔細閱讀鍋具廠家提供的說明書。

電磁爐頭鍋具選擇



- 嚴禁使用邊緣參差不齊或底部彎曲變形的鍋具。

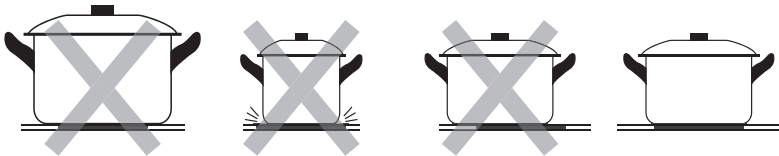

- 必須確保鍋具的底部是光滑的，平放在玻璃上，鍋底大小符合電磁爐烹飪區域面積。必須使用直徑符合電磁爐烹飪區域上標示的鍋具。如使用一個稍微寬一點的鍋具，能源將被最大效率地使用。如果使用較小的鍋，效率可能低於預期，請始終把你的鍋具放在電磁爐烹飪區域中央。

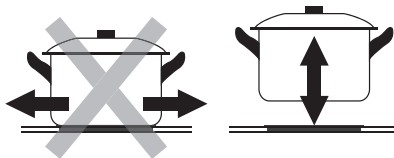

- 移動鍋具時，請完全提起鍋具離開電磁爐，切勿拖動，否則可能會刮花微晶玻璃。

使用說明

控制面板

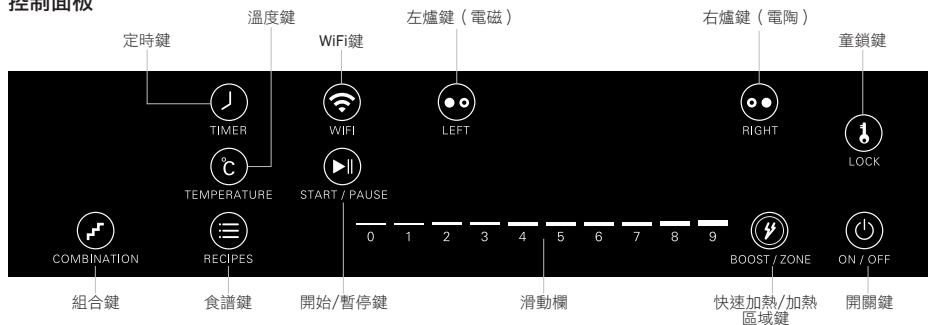

按鍵		說明
	開關鍵	按此鍵開機或關機
	童鎖鍵	<ul style="list-style-type: none"> 按此鍵啟動或解除童鎖 童鎖啟動後所有按鍵均無法操作
	左爐頭鍵 (電磁爐)	按此鍵啟用左爐頭 (電磁爐)
	右爐頭鍵 (電陶爐)	按此鍵啟用右爐頭 (電陶爐)
	滑動欄	滑動或點按以調校火力檔位、時間、溫度等
	快速加熱/加熱 區域鍵	<ul style="list-style-type: none"> 使用左爐頭 (電磁爐) 期間按此鍵即時將火力增至最大 使用右爐頭 (電陶爐) 期間按此鍵轉換單雙環加熱區域
	開始/暫停鍵	烹調過程中按此鍵暫停加熱，再按此鍵恢復加熱
	定時鍵	<ul style="list-style-type: none"> 烹調期間按此鍵進入定時關機設置 使用食譜功能時，按此鍵進入定時開機設置，詳見「C. 食譜功能」
	食譜鍵	<ul style="list-style-type: none"> 按此鍵自訂及使用食譜，或記錄烹調步驟並儲存成食譜，詳見「C. 食譜功能」 最多可儲存9個食譜
	組合鍵	使用食譜功能時，按此鍵自訂食譜或修改食譜，詳見「C. 食譜功能」
	溫度鍵	按此鍵使用控溫烹調功能，詳見「B. 溫度探針及控溫功能」
	WiFi鍵	按此鍵啟用WiFi連接功能，詳見「D. 使用WiFi連接本產品」

使用說明

A. 基本操作

開始烹調

1. 接通電源後，按「開關鍵」開機，「左爐頭鍵」及「右爐頭鍵」左側顯示「-」，產品進入待機狀態。
2. 按「左爐頭鍵」選擇電磁爐，或按「右爐頭鍵」選擇電陶爐，對應的爐頭鍵左側閃爍顯示「0.」，代表已啟動爐頭。
3. 使用「滑動欄」調校火力檔位並開始烹調：向右滑動增大檔位，向左滑動降低檔位，或直接按0-9選擇檔位。烹調期間，如需調校火力檔位，先按對應的爐頭鍵，再使用「滑動欄」調校火力檔位。
4. 烹調期間，如需暫停加熱，先按對應的爐頭鍵，再按「開始/暫停鍵」，對應的爐頭鍵左側顯示「||.」代表已暫停加熱；再按一次「開始/暫停鍵」即可恢復加熱。
5. 烹調完成後，按「開關鍵」關機。

注意：

- 開機後必須先按「左爐頭鍵」或「右爐頭鍵」選擇爐頭後，方可進行其他操作，否則其他按鍵無效。
- 如使用電陶爐，關機後「右爐頭鍵」左側顯示「H」，表示爐面溫度>60°C，嚴禁觸摸。

電陶爐切換加熱區域

烹調期間，如需切換加熱區域，先按「右爐頭鍵」，再按「快速加熱/加熱區域鍵」切換單環或雙環。

電磁爐一鍵猛火功能

烹調期間，先按「左爐頭鍵」，再按「快速加熱/加熱區域鍵」可即時將火力增至最大。

童鎖功能

1. 開機後，長按「童鎖鍵」3秒啟動童鎖功能，此時所有按鍵均無法操作。
2. 如需取消童鎖功能，再次長按「童鎖鍵」3秒。

使用說明

定時關機

1. 烹調期間，按「定時鍵」進入定時關機設置，「定時鍵」左側閃爍顯示「00:00」。
2. 按「滑動欄」上的數字直接輸入時間，可設置1分鐘至12小時定時；例子如下：
 - 如需定時50分鐘，輸入「0」、「0」、「5」、「0」
 - 如需定時5小時30分鐘，輸入「0」、「5」、「3」、「0」；
 - 如需定時11小時59分鐘，輸入「1」、「1」、「5」、「9」。

注意：

第1位元最大數值為「1」，代表10小時。如第1位元選擇「1」後，第2位元最大數值為「2」，代表12小時，第3及第4位元必定為「0」，代表12小時（最長定時關機時間為12小時）。

3. 如3秒內無任何操作將自動確認當前設置，顯示屏轉為顯示剩餘倒數時間。倒數完畢後自動關機。
4. 如需修改定時時間，按「定時鍵」後重新輸入時間；如需取消定時，輸入「0000」即可。

強制關機功能

在待機或烹調狀態下，當爐面有積水或長按任何兩個或以上的按鍵超過3秒，蜂鳴器會發出急促提示聲，如3秒內不抹乾或不放手，產品將自動強制關機。

電磁乾燒保護

在使用期間，當爐面溫度大於230°C時，電磁爐將停止加熱，「左爐頭鍵」左側顯示「E2」，蜂鳴器持續發出提示聲；如需繼續烹調，待機身冷卻後，手動恢復工作狀態。

使用說明

B. 溫度探針及控溫功能

溫度探針

將溫度探針與爐頭配對後，透過溫度探針實時測溫及實現控溫烹調。溫度探針內含鋰電池，使用前必須先充電，充電方法如下：

1. 將跟機附送的充電座連接USB電源插座。
2. 將溫度探針底部插入充電座中，充電期間溫度探針上的電量指示燈閃爍。
3. 當三個電量指示燈常亮，代表充電完成。

⚠ 警告！

- 溫度探針內含鋰電池，嚴禁擺放在火源或高溫的地方，或將整支溫度探針溫入水中，避免損壞。
- 使用溫度探針時必須存在介質(食物或水份)，嚴禁空鍋使用。

控溫烹調功能

1. 接通電源後，按「開關鍵 (⏻)」開機，「左爐頭鍵 (●●)」及「右爐頭鍵 (●●)」左側顯示「-」，產品進入待機狀態。
2. 按「左爐頭鍵 (●●)」選擇電磁爐，或按「右爐頭鍵 (●●)」選擇電陶爐。
3. 按「溫度鍵 (Ⓢ)」設置溫度，「溫度鍵 (Ⓢ)」左側顯示「000°C」，按「滑動欄」上的數字直接輸入溫度，可設置最高250°C；例子如下：
 - 如需設置溫度為50°C，輸入「0」、「5」、「0」
 - 如需設置溫度為130°C，輸入「1」、「3」、「0」；
 - 如需設置溫度為230°C，輸入「2」、「3」、「0」。

注意：

注意：第1位元最大數值為「2」，代表200°C。如第1位元選擇「2」後，第2位元最大數值為「3」，代表230°C（最高可設置溫度為230°C）。

4. 如3秒內無任何操作將自動確認當前設置，顯示屏轉為顯示「----」。
5. 將溫度探針卡入硅膠支架的固定槽，再將硅膠支架固定在鍋具邊沿，確保溫度探針的尖頭浸入鍋內的浸體或插入食物中。
6. 按溫度探針上的按鍵一次與爐頭進行配對，配對成功後，爐頭顯示屏轉為顯示實時溫度。
7. 此時爐頭將自動進行烹調，自動調節火力檔位加熱至所設定的溫度，並保持恆溫。

注意：

- 如未能成功配對溫度探針，再按溫度探針上的按鍵一次重新配對。
- 使用前請先將溫度探針清潔乾淨，及必須將溫度探針充滿電，避免使用過程中因電力不足而影響烹調效果。

使用說明

C. 食譜功能

預設食譜

本產品出廠時已內存9個預設食譜（電磁爐及電陶爐通用；火力、時間、溫度不可調），用戶可因應不同需要選用不同編號的食譜烹調。

食譜編號	名稱	食材	步驟	火力檔位	溫度	時間
1	米飯	米及水	1		60°C	0:20:00
			2		85°C	0:05:00
			3		99°C	0:05:00
			4	2		0:05:00
			5		60°C	1:00:00
2	煲水	水	1		99°C	0:00:30
3	蒸煮		1		99°C	0:00:30
			2	4		0:20:00
4	粥	米及水	1		95°C	0:30:00
			2	1		1:00:00
5	發酵		1		50°C	1:00:00
			2		53°C	1:00:00
			3		55°C	1:00:00
6	保溫		1		60°C	1:00:00
			2		60°C	1:00:00
			3		60°C	1:00:00
7	70°C 低溫慢煮		1		70°C	1:00:00
			2		70°C	1:00:00
			3		70°C	1:00:00
8	80°C 慢煮		1		80°C	1:00:00
			2		80°C	1:00:00
			3		80°C	1:00:00
9	90°C 慢煮		1		90°C	1:00:00
			2		90°C	1:00:00
			3		90°C	1:00:00

注意：

當用戶手動設置食譜，即會蓋過並刪除產品本身該號碼的預設食譜。

使用說明

手動設置食譜

本產品共可儲存 9 個食譜（電磁爐及電陶爐通用），每個食譜可設置最多 9 個步驟，包括火力、時間等皆可自行設置。

1. 接通電源後，按「開關鍵」開機，「左爐頭鍵」及「右爐頭鍵」左側顯示「-」，產品進入待機狀態。
2. 按「左爐頭鍵」選擇電磁爐，或按「右爐頭鍵」選擇電陶爐。
3. 按「食譜鍵」，「食譜鍵」左側的數字 1-9 對應為食譜儲存位置 1-9，按「滑動欄」上的數字可選擇對應的食譜儲存位置。
4. 按「組合鍵」，「組合鍵」左側顯示「1」代表步驟 1；此時可設置時間、溫度及火力檔位：
 - 按「定時鍵」設置烹調時間（可設置 1 分鐘 00:01 至 99 分鐘 59 秒 99:59）；
 - 按「溫度鍵」設置烹調溫度（可設置最高 230 度）；
 - 按「爐頭鍵」後使用「滑動欄」調校火力檔位。
5. 設置完成後按「組合鍵」，再按「滑動欄」上的數字 2，「組合鍵」左側顯示「2」代表步驟 2。重覆以上操作以設置最多 9 個步驟。
6. 設置完成後按「組合鍵」，再長按「食譜鍵」3 秒儲存食譜。

注意：

- 設置步驟時必須按照 1-9 的順序進行設置，請勿略過中間步驟（例如設置完步驟 1 後直接跳到步驟 9），避免程式錯誤。
- 並非將步驟 1-9 全部設置完成後才可儲存食譜；任何步驟設置完成後，按「組合鍵」再長按「食譜鍵」即可儲存食譜。
- 如需修改現有食譜，請按「手動設置食譜」部份的說明進行操作，直接取代舊有食譜。
- 如按「溫度鍵」使用控溫烹調功能，必須先將溫度探針與爐頭配對；爐頭會在達到目標溫度後才開始倒數。

使用說明

透過烹飪記錄設置食譜

1. 接通電源後，按「開關鍵 (⏻)」開機，「左爐頭鍵 (●●)」及「右爐頭鍵 (●●)」左側顯示「-」，產品進入待機狀態。
2. 按「左爐頭鍵 (●●)」選擇電磁爐，或按「右爐頭鍵 (●●)」選擇電陶爐。
3. 按「食譜鍵 (≡)」，再按「滑動欄」上的0，「食譜鍵 (≡)」左側的數字顯示「0」，代表進入烹調記錄模式。
4. 按「開始/暫停鍵 (▶||)」開始記錄，此時對爐頭的操作包括調校火力、溫度、暫停烹調等皆會以步驟的形式記錄入食譜內（最多9個步驟），「組合鍵 (Ⓜ)」左側的數字會隨操作次數遞增。
5. 烹調完成後，按「開關鍵 (⏻)」關機，「食譜鍵 (≡)」左側的數字閃爍顯示「1」。
6. 如確認儲存當次記錄的食譜，按「滑動欄」上的數字選擇對應的食譜儲存位置，再長按「食譜鍵 (≡)」即可。

注意：

烹調完成後，如無需儲存食譜，再按一次「開關鍵 (⏻)」關機。

使用已儲存的食譜

1. 接通電源後，按「開關鍵 (⏻)」開機，「左爐頭鍵 (●●)」及「右爐頭鍵 (●●)」左側顯示「-」，產品進入待機狀態。
2. 按「左爐頭鍵 (●●)」選擇電磁爐，或按「右爐頭鍵 (●●)」選擇電陶爐。
3. 按「食譜鍵 (≡)」再按「滑動欄」上的數字可選擇對應食譜。
4. 如需定時開機，按「定時鍵 (⌚)」後，按「滑動欄」上的數字直接輸入時間，如3秒內無任何操作將自動確認當前設置，顯示屏轉為顯示剩餘倒數時間。倒數完畢後自動開始烹調。
5. 如無需定時，按「開始/暫停鍵 (▶||)」直接開始烹調。

清潔及保養

⚠ 警告！

- 清潔前必須先關掉本產品電源，並待爐面完全冷卻後方可進行清潔。
- 如本產品出現故障或需要保養維修，先拔掉電源插頭，並聯絡德國寶顧客服務及維修中心。檢查及維修必須由德國寶專業維修員進行。嚴禁自行拆卸本產品。

注意：

- 嚴禁使用粗糙抹布、百潔布、鋼絲球或硬刷清潔本產品，以免刮花玻璃面板。
- 嚴禁使用漂白水、含苯、汽油、天拿水、腐蝕性化學溶劑或有機性溶劑清潔本產品。嚴禁使用蒸氣清潔器。
- 嚴禁用水直接沖洗或將機身浸入水中清洗，防止水、異物進入爐體。
- 嚴禁用水沖洗本產品的進風口及出風口。

1. 日常清潔，以乾軟布抹拭即可。
2. 每次使用後，立即用微濕軟布抹去玻璃面板上的污漬或食物殘渣，再用乾軟布抹乾。
3. 頑固污漬可以沾上稀釋洗潔精的微濕海綿清潔，再用微濕軟布抹拭，最後以乾軟布抹乾。
4. 進風口及出風口使用柔軟乾布輕拭，清理灰塵時，請使用柔軟毛刷或微型吸塵器。
5. 嚴禁將溫度探針浸入水中或淋水。
6. 若長時間不使用本產品，請拔掉電源插頭，並做好產品的防潮、防塵、防蟲。

注意：

經長時間使用後，玻璃面板或會因以下幾種情況會造成變色，實屬正常，不影響電磁爐正常使用：
爐面長期過熱或鍋具乾燒；湯汁溢瀉後未及時清潔；使用的鍋具底部不潔淨。

故障檢修

現象	問題	解決方法
控制面板無反應	插頭是否脫落？	確保插頭穩妥插入
	保險絲或斷路器是否已跳開？	請持牌電工檢查電箱
	插座是否不通電？	確保插座正常通電
無法控制溫度	鍋具底部是否凹凸不平，或中心部位凹陷？	選用平底鍋
	中央溫控器故障，是否有故障代碼 E2/E9？	聯絡德國寶客戶服務及維修中心
顯示錯誤代碼「U」	鍋具是否合適？	選用合適鍋具
	鍋具是否置於面板的中央？	將鍋具擺正於面板中央
	鍋具底部直徑是否小於12cm？	選用鍋底直徑大於12cm的鍋具
使用期間突然停止加熱	四周環境溫度是否很高？	本產品必須在合適溫度環境下使用
	進風口或出風口是否被堵塞；風扇是否轉動？	移除堵塞物；如風扇仍然不轉動，聯絡德國寶客戶服務及維修中心
	控溫狀態時，表示溫度已達到所設定溫度	正常現象
	電磁爐安全保護啟動	請等數秒至少20秒後再重新開機
Wi-Fi無法連接	用戶APP版本是否為最新？	請更新APP版本
	安裝電磁爐的位置WiFi強度是否足夠？	增強產品擺放位置的WiFi接收
無法更新軟件	是否處於工作過程中？	工作過程中，軟件無法更新，待工作完成後再更新軟件
	WiFi連接是否正常？	確保WiFi信號良好
顯示錯誤代碼「E7」	電源電壓大於260V，蜂鳴器響起警報	當電壓恢復正常，蜂鳴器關閉，產品恢復原來工作狀態
顯示錯誤代碼「E8」	電源電壓小於170V，蜂鳴器響起警報	當電壓恢復正常，蜂鳴器關閉，產品恢復原來工作狀態
顯示錯誤代碼「E3」	IGBT熱敏電阻開路，蜂鳴器響起警報	手動關機，待爐面冷卻後再開機。如情況持續，聯絡德國寶客戶服務及維修中心
顯示錯誤代碼「E4」	IGBT熱敏電阻短路，蜂鳴器響起警報	手動關機，聯絡德國寶客戶服務及維修中心
顯示錯誤代碼「E9」	爐面熱敏電阻開路，蜂鳴器響起警報	手動關機，待爐面冷卻後再開機。如情況持續，聯絡德國寶客戶服務及維修中心
顯示錯誤代碼「E2」	爐面熱敏電阻短路，蜂鳴器響起警報	手動關機，聯絡德國寶客戶服務及維修中心

技術規格

型號	GIH-PD50B-SC
電壓	220-240 V
頻率	50-60 Hz
功率	左：電磁爐 2,800W / 右：電陶爐 2,200W
電流	13A x 2
產品尺寸	(H) 55 (W)730 (D)430 mm (不連腳)
	(H) 72 (W)730 (D)430 mm (連腳)
嵌入尺寸	(H) ≥305 (W)680 (D)380 mm
淨重	9.3 kg
總重連包裝	11.1 kg

- 產品規格及設計如有變更，恕不另行通知。
- 中英文版本如有出入，一概以中文版為準。
- 本產品使用說明書以www.germanpool.com網上版為最新版本。

如欲獲取更多有關本產品最新資訊，歡迎瀏覽本公司網站
For the latest information about this product, please visit our website

www.germanpool.com

保用條款

此保用提供德國寶產品之機件在正常使用下壹年保用 (自購買日起計算)。

Warranty Terms & Conditions

Under normal operations, the product will guarantee a 1-year full warranty provided by German Pool (effective from the date of purchase).

* 貴戶須在購機十天內，以下列其中一種方式向本公司登記資料，保用手續方正式生效：

- 1) 填妥德國寶VIP手機應用程式保用登記表 (掃描右方二維碼)
- 2) 填妥本公司網頁保用登記表
www.germanpool.com/warranty
- 3) 填妥保用手郵寄至本公司。



* This warranty is not valid until customer registration information is received by our Service Centre within 10 days of purchase via one of the following means:

- 1) Visit our VIP App and register online:
(Scan the QR Code on the right)
- 2) Visit our website and register online:
www.germanpool.com/warranty
- 3) Complete the attached Warranty Card and mail it back to our Customer Service Centre.



另請填妥以下表格並與正本發票一併保存，以便維修時核對資料。用戶提供之所有資料必須正確無誤，否則免費保用將會無效。 Please fill out the form below. This information and the original purchase invoice will be required for any repairs. Warranty will be invalidated if information provided is found to be inaccurate.

型號 Model No. : GIH-PD50B-SC

機身號碼 Serial No. : _____ 發票號碼 Invoice No. : _____

購買商號 Purchased From : _____ 購買日期 Purchase Date : _____

1. 未能出示購買發票正本者，將不獲免費維修服務。
2. 用戶應依照說明書的指示操作。本保用並不包括：
 - 上門安裝、檢驗、維修或更換零件之人工以及一切運輸費用；
 - 因天然與人為意外造成的損壞 (包括運輸及其他)；
 - 電源接合不當、不依說明書而錯誤或疏忽使用本機所引致之損壞。
3. 於下列情況下，用戶之保用資格將被取消：
 - 購買發票有任何非認可之刪改；
 - 產品被用作商業或工業用途；
 - 產品經非認可之技術人員改裝或加裝任何配件；
 - 機身編號被擅自塗改、破壞或刪除。
4. 總代理有權選擇維修或更換配件或其損壞部份。
5. 產品一經被轉讓，其保用即被視作無效。

1. Customer who fails to present original purchase invoice will not be eligible for free warranty service.
2. Customer should always follow the operating instructions. This warranty does not apply to:
 - labour costs for on-site installation, check-up, repair, replacement of parts and other transportation costs;
 - damages caused by accidents of any kind (including material transfer and others);
 - operating failures resulting from applying incorrect voltage, improper usage, and unauthorized installations or repairs.
3. This warranty is invalid if:
 - the purchase invoice is modified by an unauthorized party;
 - the product is used for any commercial or industrial purposes;
 - the product is repaired or modified by unauthorized personnel, or unauthorized parts are installed;
 - the serial number is modified, damaged or removed from the product.
4. German Pool will, at its discretion, repair or replace any defective part.
5. This warranty will be void if there is any transfer of ownership from the original purchaser.

客戶服務及維修中心

中國香港

九龍大業街59號

三湘九龍灣貨運中心地下B室

電話：+852 2773 2888

傳真：+852 2356 9798

電郵：repairs@germanpool.com

中國澳門

澳門青洲大馬路(青洲新路)

515號美居廣場第二期1樓A座

電話：+853 2875 2699

傳真：+853 2875 2661

Customer Service & Repair Centre

Hong Kong, China

Unit B, G/F, Sunshine Kowloon Bay

Cargo Centre, 59 Tai Yip Street,

Kowloon, Hong Kong

Tel : +852 2773 2888

Fax : +852 2356 9798

Email : repairs@germanpool.com

Macau, China

A.1 Andar, Mei Kui Kuong Cheong Fase 2,

No.515 Avenida Do Conselheiro Borja

Macau

Tel : +853 2875 2699

Fax : +853 2875 2661

此保用只適用於香港及澳門

This warranty is valid only in Hong Kong and Macau

German Pool (Hong Kong) Limited

Hong Kong, China

Room 113, Newport Centre Phase II, 116 Ma Tau
Kok Road, Tokwawan, Kowloon, Hong Kong.
Tel: +852 2773 2888
Fax: +852 2765 8215

Mainland, China

8th, Xinxiang Road, Wusha Industrial Park,
Daliang, Shunde, Foshan, Guangdong
Tel: +86 757 2219 6888
Fax: +86 757 2219 6809

Macau, China

A, 1 Andar, Mei Kui Kuong Cheong Fase 2,
No.515 Avenida Do Conselheiro Borja, Macau
Tel: +853 2875 2699
Fax: +853 2875 2661



香港《S MARK》
安全認證



中國櫥櫃/家電行業
十大影響力品牌



CEO非凡品牌大賞



香港優質商標



香港工商業獎



2007
最具發展
創建品牌企業獎



香港中小企業
最佳成績大獎



HONG KONG
CONSUMER CHOICE
2007
香港消費者推薦品牌



香港《O標》
優質服務證書



香港名牌十年成就獎
HONG KONG TOP BRAND TEN YEAR
ACHIEVEMENT AWARD

©All rights reserved. Copying, reproducing or using the contents of this manual is not allowed without prior authorization from German Pool, violators will be prosecuted.

WiFi Smart Built-in
Induction & Ceramic Hybrid Cooker

GIH-PD50B-SC



Online Warranty Registration



Please read these instructions and warranty information carefully before use and keep them handy for future reference.

WiFi CONNECTION QUICK GUIDE

Download The App

Connecting The Product To WiFi

This product can be controlled via smartphone with German Pool Smart Control APP.

Note:

To connect the product to WiFi, please use WiFi with a frequency of 2.4 GHz, does not work with WiFi with a frequency of 5.0 GHz.

A. How To Set Up The APP

1. Connect your phone to 2.4 GHz WiFi then scan the QR Code below, or search "German Pool Smart Control" in App Store or Google Play to download and install the APP.



Apple iOS System
App Store



Android System
Google Play

B. Change The Language

Apple IOS System

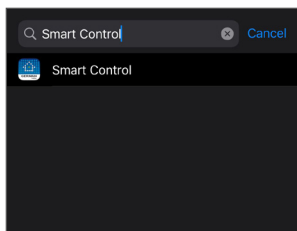

1. Search "Smart Control" in Settings.

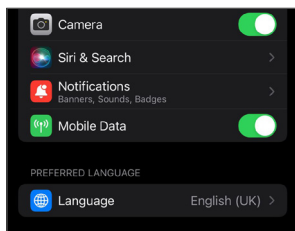

2. Click "Preferred Language".

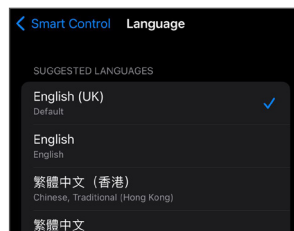

3. Select Traditional Chinese or English in the "Suggested Languages" column (Note: if user select "Traditional Chinese (Hong Kong)", app will display in English).

Android System

App will appear in your preset phone language. If you need to change APP language, you need to change the system language in your phone settings.

Download the App

C. Register Your Account

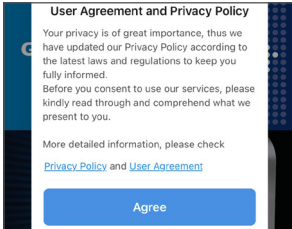

1. Open the APP , click “Agree” on “User Agreement and Privacy Policy”.

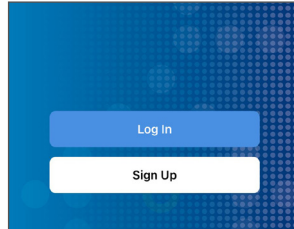

2. Click “Sign Up” to register your account.

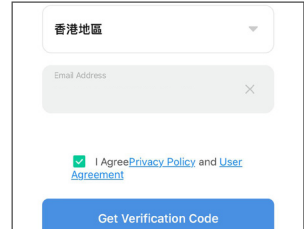

3. Enter your email address, tick “I agree Privacy Policy and User Agreement”, then click “Get Verification Code”.

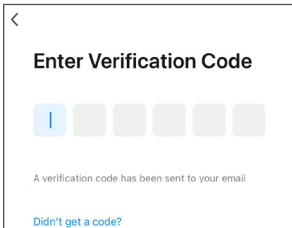

4. Enter one-time verification code from your email.

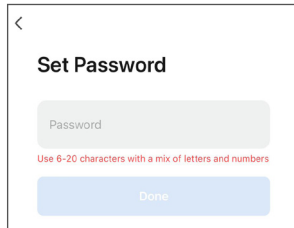

5. Set up your password then click “Done”.

Pairing Sequence

D. Pairing Sequence

Method 1: Auto Pairing



1. Tap and hold the cooker's WiFi Key for 3 seconds until buzzer beeps and WiFi Indicator Light blinks.

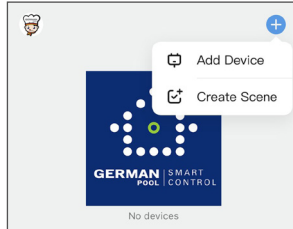

2. Click "+" on the upper right corner of the APP homepage, then click "Add Device".

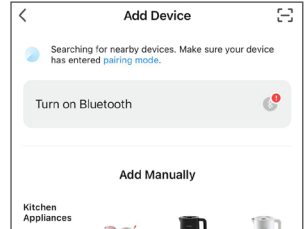

3. Before pairing, user must allow the App to access your Bluetooth. Tap on "Turn on Bluetooth" (if Bluetooth is already on, ignore this step).

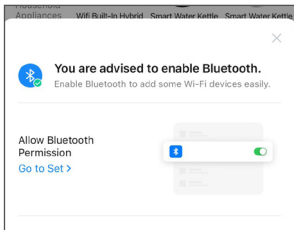

4. Tap "Go To Set" (if Bluetooth is already on, ignore this step).

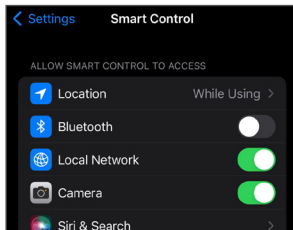

5. Turn on Bluetooth (if Bluetooth is already on, ignore this step).

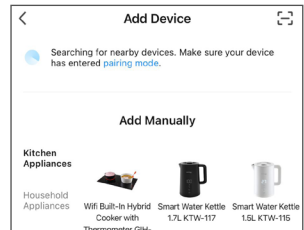

6. APP will show "Searching for nearby devices..."

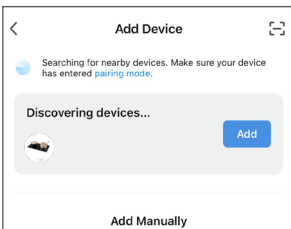

7. APP will show "Discovering devices...", click "Add".

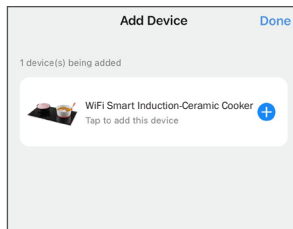

8. Click "+" on the right of product name.

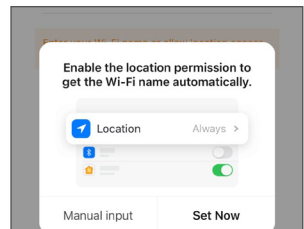

9. it is recommended to allow the APP to access your location. Tap "Set Now" (if Location is already on, ignore this step).

Pairing Sequence

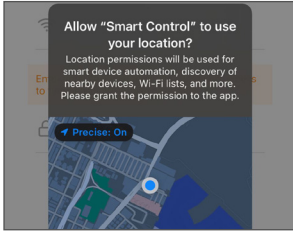

10. Tap “Allow While Using App” (if Location is already on, ignore this step).

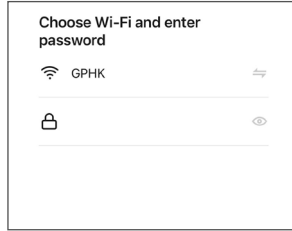

11. Select WiFi name and enter your WiFi password, then click “Next”.

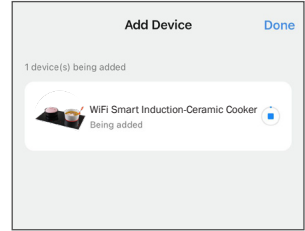

12. APP will show “Being Added”, the product and APP will automatically pair up.

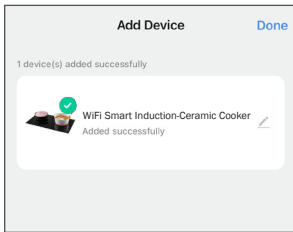

13. When pairing is completed, APP will show “Added successfully”. Click “Done” to return to homepage.

⚠ WARNING!

If Bluetooth is turned off or App is not permitted to access Bluetooth, the product cannot be paired. (Note: Even if Bluetooth is turned on, it does not mean the APP is allowed to access your Bluetooth.)

Note:

- The product can only be paired to one account at a time. If another user pairs their smartphone to the product, the previous account will lose their control of the product.
- User who has already been paired can share their control rights with other users. For details, see “E. Sharing Control”.

Note:

If APP cannot find the product, or during Pairing Sequence, if APP shows an exclamation mark icon, it means pairing is unsuccessful. Please use method 2 below for pairing.

Pairing Sequence

Method 2: Bluetooth Pairing

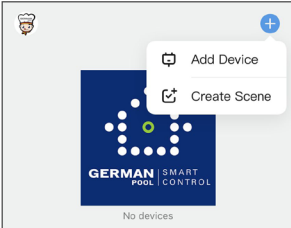

1. Click “+” on the upper right corner of the APP homepage, then click “Add Device”.

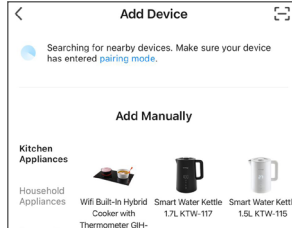

2. In the “Add Manually “ column, find the product model that needs to be paired, and click the product to pair.



3. Follow the instructions on the APP to pair.

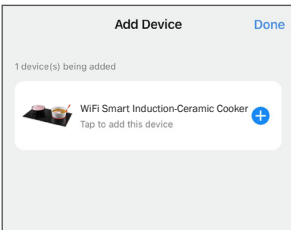

4. Click “+” on the right of product name.

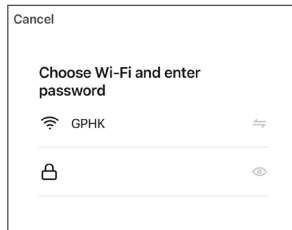

5. Select WiFi name and enter your WiFi password, then click “Next”.

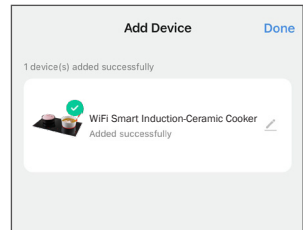

6. When pairing is completed, APP will show “Added successfully”. Click “Done” to return to homepage.

⚠ WARNING!

If Bluetooth is turned off or App is not permitted to access Bluetooth, the product cannot be paired. (Note: Even if Bluetooth is turned on, it does not mean the APP is allowed to access your Bluetooth.)

Pairing Sequence

E. Sharing Control

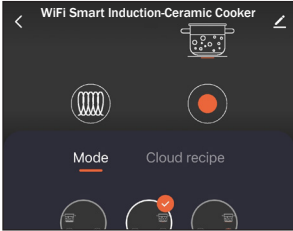

1. On the product's homepage, click “✎” on the upper right corner.

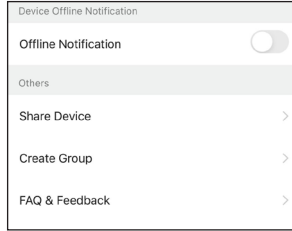

2. Click “Share Device” under “Others”.

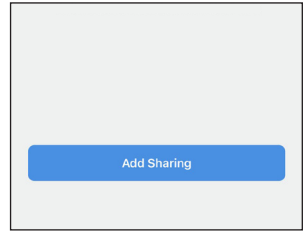

3. Click “Add Sharing”.

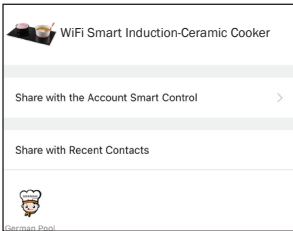

4. Set the number of users with whom you wish to share control, then click “Share with the Account Smart Control”.

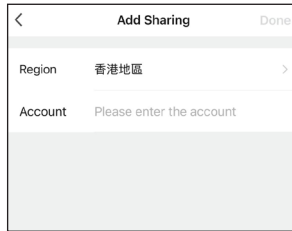

5. Enter that account's registered email address, then click “Done” on the upper right corner.

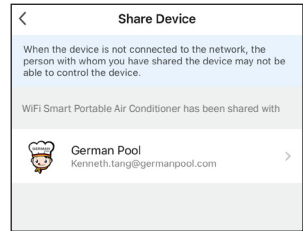

6. Repeat step 3-5 to share with more accounts.

Note:

On the “Share Device” page, you can add or delete other accounts' control rights.

Using The App

Using The App

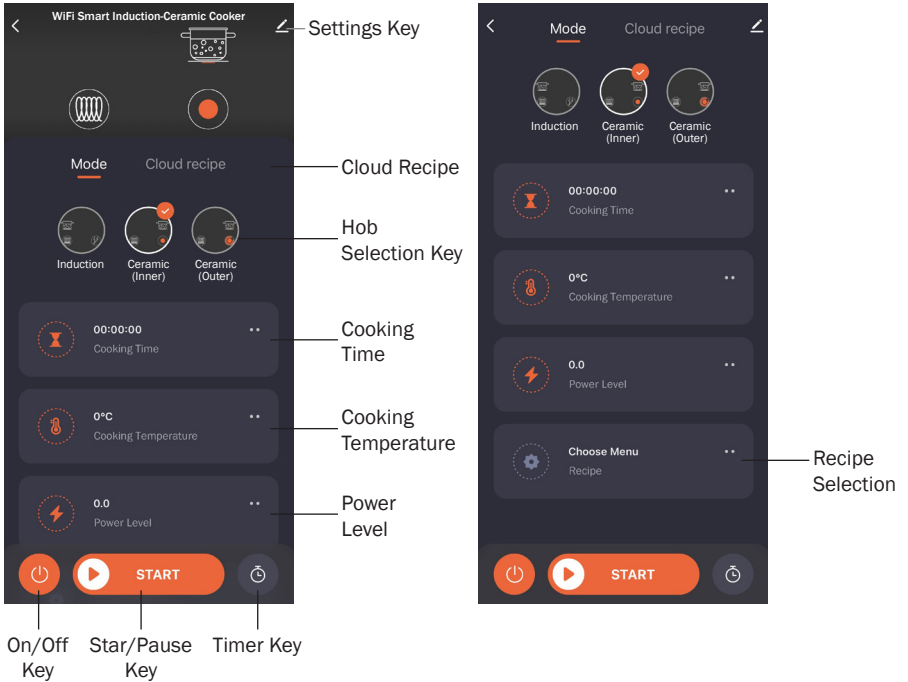

Key	Description
On/Off Key	Tap to turn product on or off
Start/Pause Key	<ul style="list-style-type: none"> After setting is completed, tap this key to start cooking During cooking, tap this key to pause cooking, then tap again to resume
Timer Key	<ul style="list-style-type: none"> Tap this key to enter On-timer (time to start cooking) setting On-timer can only be used when using Recipes Function or Cloud Recipe
Cloud Recipe Key	Tap this key to view or use Cloud Recipe
Hob Selection Key	Tap this key to select Induction Hob / Ceramic (Inner Hob) / Ceramic (Outer Hob)
Cooking Time Key	Tap this key to set Off-timer (time to stop cooking), product will automatically turn off when countdown finishes
Cooking Temperature Key	<ul style="list-style-type: none"> Set cooking temperature; when temperature probe is paired up with the hob, user can control real-time cooking temperature of the hob Temperature probe must be paired up to the hob before cooking begins. For details, please see User Manual P.13 "B. Temperature Probe & Temperature Control Function" section
Power Level Key	Tap this key to adjust power level
Recipe Selection	Tap this key to use any stored recipe. To use this function, user must first save recipe. For details, please see User Manual P.15 "C. Recipes Function" section

下載應用程式App

使用WiFi連接本產品

本產品可透過德國寶智能控制應用程式「German Pool Smart Control」APP以智能手機操控。

注意：

必須使用頻率為2.4 GHz的WiFi進行連接，不適用於頻率為5.0 GHz的WiFi。

A. 下載應用程式

連接頻率為2.4 GHz的WiFi後，掃描下方二維碼，或於蘋果iOS系統上的App Store或安卓Android系統上的 Google Play搜尋「German Pool Smart Control」，下載並安裝APP。



蘋果iOS系統
App Store



安卓Android系統
Google Play

B. 設置APP語言

蘋果iOS系統

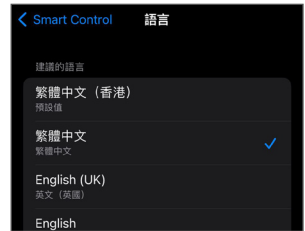
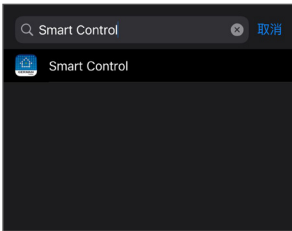

1. 在手機的設定中搜尋「Smart Control」。
2. 點擊「偏好的語言」。
3. 在「建議的語言」一欄中選擇繁體中文或英文（注意：選擇「繁體中文(香港)」APP將會顯示英文）。

安卓Android系統

預設為系統所使用的語言，如需更改APP語言，需在設置中更改系統語言。

下載應用程式App

C. 註冊用戶資料

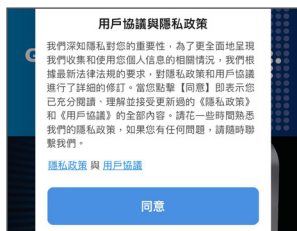

1. 打開APP，點擊「用戶協議與隱私政策」上的「同意」。
2. 點擊「註冊」註冊用戶資料。
3. 輸入電郵地址，剔選「我同意隱私政策與用戶協議」後點擊「獲取驗證碼」。



4. 輸入電郵裡的驗證碼。
5. 設定您的登入密碼後點擊「完成」，完成註冊。

進行配對

D. 配對本產品

方法1：自動配對



1. 長按煮食爐上的「WiFi 鍵」3秒，直至蜂鳴器發出提示聲，WiFi指示燈閃爍。



2. 點擊APP主頁右上角「+」，再點擊「添加設備」。



3. 配對前必須先打開藍牙權限，點擊「打開藍牙」（如已打開，可忽略此步驟）。



4. 點擊「去設定」（如已打開，可忽略此步驟）。

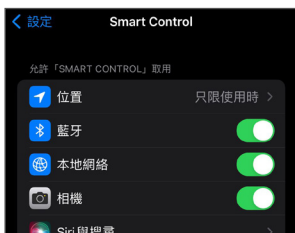

5. 點擊藍牙一欄以打開藍牙權限（如已打開，可忽略此步驟）。



6. APP顯示「正在搜索附近的設備...」。



7. 數秒後APP顯示「發現設備...」，點擊「添加」。



8. 點擊產品名稱右方的「+」。



9. 配對時建議開啟位置權限，點擊「立即設置」（如已開啟，可忽略此步驟）。

進行配對

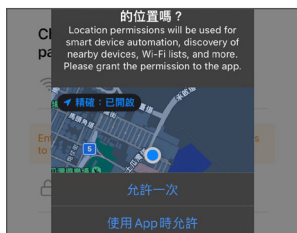

10. 點擊「使用APP時允許」（如已開啟，可忽略此步驟）。



11. 輸入手機所連接的WiFi名稱及密碼，點擊「下一步」。



12. APP顯示「正在添加」，產品與APP自動配對中。



13. 配對完成後APP顯示「添加成功」，按右上角「完成」進入產品主界面。

⚠ 警告！

如沒有開啟藍牙或沒有打開藍牙權限，將無法配對產品；注意，即使電話已開啟藍牙功能，並不代表已打開「藍牙權限」。

注意：

- 每次只可以一個帳戶進行配對，如由另一帳戶再次進行配對，先前已配對的帳號將失去本產品的操作權。
- 已配對的帳戶可以分享本產品的操作權予其他帳戶，詳見「E. 操作權分享」部份。

注意：

如無法搜索到本產品，或在配對期間APP顯示感嘆號符號，代表配對失敗，請使用下列的方法2進行配對。

進行配對

方法2：藍牙配對



1. 點擊APP主頁右上角「+」，再點擊「添加設備」。



2. 在「手動添加」一欄找到需要配對的產品型號，點擊該產品進行配對。



斷電10秒後，重新通電

3. 按照APP上的指示進行配對。



4. 點擊產品名稱右方的「+」。



5. 輸入手機所連接的WiFi名稱及密碼，點擊「下一步」。



6. 配對完成後APP顯示「添加成功...」，按右上角「完成」進入產品主界面。

⚠ 警告！

如沒有開啟藍牙或沒有打開藍牙權限，將無法配對產品；注意，即使電話已開啟藍牙功能，並不代表已打開「藍牙權限」。

進行配對

E. 操作權分享



1. 在本產品操作主界面點擊右上角「」。



2. 在「其他」一欄中點擊「共用設備」。



3. 點擊下方「添加共用」。



4. 在「分享給其他人」一欄中可設定所需分享的人數，再點擊「分享給 SmartControl賬號」。



5. 輸入該帳戶的註冊電郵地址，再點擊右上角「完成」即可。



6. 重複步驟3-5添加更多其他帳戶。

注意：

在「共用設備」頁面裡，你可隨時添加或移除帳戶的操作權。

使用App操作產品

使用APP操作

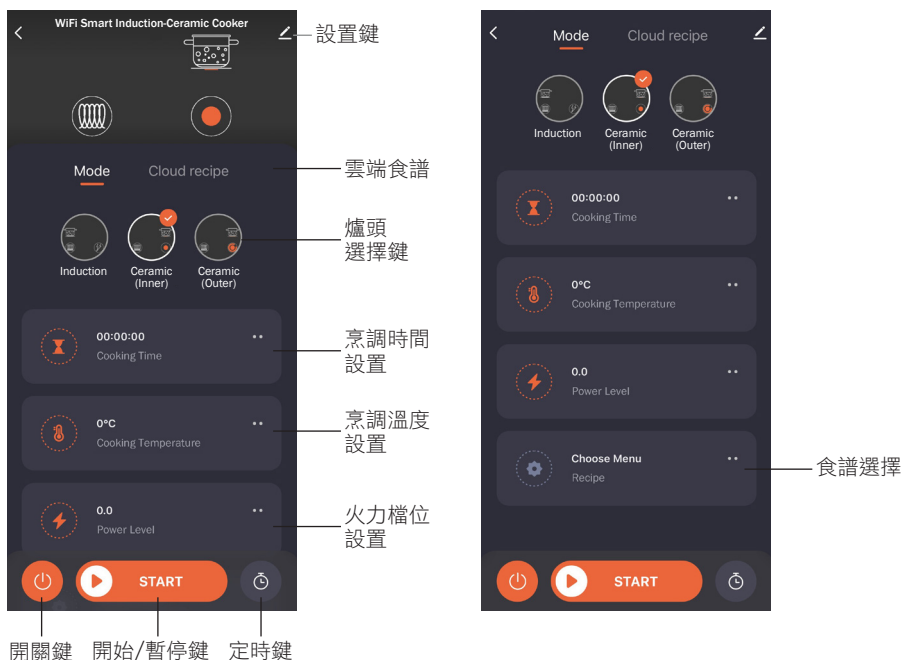

按鍵	說明
開關鍵	按此鍵開機或關機
開始/暫停鍵	<ul style="list-style-type: none"> 設置完成後按此鍵開始烹調 烹調過程中按此鍵暫停加熱，再按此鍵恢復加熱
定時鍵	<ul style="list-style-type: none"> 按此鍵進入定時開機設置 使用「食譜功能」或「雲端食譜」時方可使用定時開機功能
雲端食譜	按此鍵觀看或使用雲端食譜
爐頭選擇鍵	按鍵選擇電磁爐、電陶爐（內環）或電陶爐（外環）
烹調時間設置	設置定時關機時間，倒數完畢後自動關機
烹調溫度設置	<ul style="list-style-type: none"> 設置烹調溫度；將溫度探針與爐頭配對後，透過溫度探針實現控溫烹調 烹調前必須先將溫度探針與爐頭配對，詳見使用說明書P. 31「B. 溫度探針及控溫功能」部份
火力檔位設置	調校火力檔位
食譜選擇	使用已儲存在煮食爐的食譜。必須先在煮食爐上儲存食譜後方可使用此功能，詳見使用說明書P. 32「C. 食譜功能」

German Pool (Hong Kong) Limited

Hong Kong, China

Room 113, Newport Centre Phase II, 116 Ma Tau
Kok Road, Tokwanan, Kowloon, Hong Kong.
Tel: +852 2773 2888
Fax: +852 2765 8215

Mainland, China

8th, Xinxiang Road, Wusha Industrial Park,
Daliang, Shunde, Foshan, Guangdong
Tel: +86 757 2219 6888
Fax: +86 757 2219 6809

Macau, China

A, 1 Andar, Mei Kui Kuong Cheong Fase 2,
No.515 Avenida Do Conselheiro Borja, Macau
Tel: +853 2875 2699
Fax: +853 2875 2661



香港《S MARK》
安全認證



中國郵政/家電行業
十大影響力品牌



CEO非凡品牌大賞



香港優質商標



香港工商業獎



2007
最具潛質
創星品牌企業獎



香港中小企業
最佳拍檔大獎



香港消費者推祟品牌



香港《Q標》
優質服務證書



香港名牌十年成就獎
HONG KONG TOP BRAND TEN YEAR
ACHIEVEMENT AWARD

©All rights reserved. Copying, reproducing or using the contents of this manual is not allowed without prior authorization from German Pool, violators will be prosecuted.