

GERMAN
POOL



德國寶

光波萬能煮食鍋
Halogen Cooking Pot

CKY-882
CKY-888

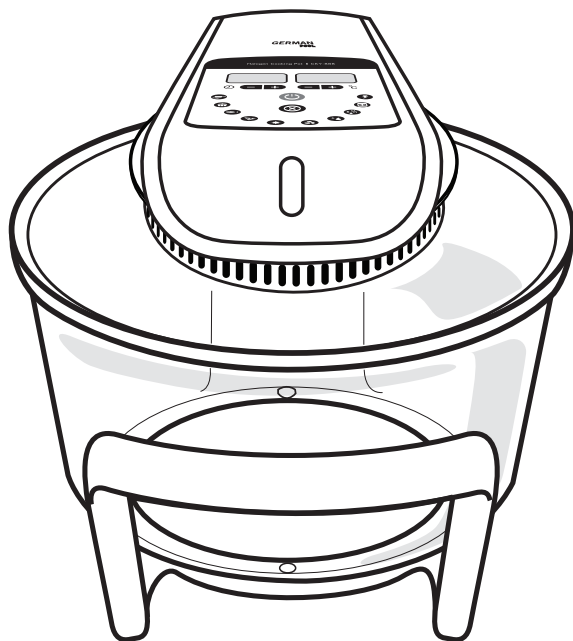

即時網上登記保用
Online Warranty Registration



在使用之前請詳細閱讀「使用說明書」及「保用條款」，並妥為保存。
Please read these instructions and warranty information carefully
before use and keep them handy for future reference.

使用說明書 USER MANUAL

請即進行保用登記!

有關保用條款細則，請看本說明書最後一頁。

Please register your warranty information now!

For Warranty Terms & Conditions,

please refer to the last page of these operating instructions.

目錄

注意事項	04
產品結構	06
操作說明	07
參考食譜	09
參考烹調時間	10
清潔與保養	10
配件	11
常見故障及處理	12
技術規格	12
保用條款	23

For English instructions, please refer to P.13.
英文版說明書請參閱 P.13。

注意事項

重要說明

- 為安全起見，初次使用產品前請先細閱本說明書，並保存說明書，以便作參考之用。
- 本產品只供家居使用。請必須依照本說明書內的指示操作。

1. 請使用專用插座，切勿與其他電器共用電源插頭。
2. 啟動電源前，請先將鍋蓋確實蓋好。
3. 如放在不受熱的桌上使用，必須在本產品下放置隔熱墊才使用。
4. 電器工作時可能溫度會很高，請勿觸碰。
5. 本產品只供家居及其他相似的室內環境使用，例如：
 - 店舖、辦公室及其他工作場所的員工廚房
 - 農舍
 - 酒店、汽車旅館及其他類型的住所
 - 供住宿及早餐的旅館
6. 本產品並非以外置時間設定裝置或獨立的遙控器操控。
7. 第一次使用或當玻璃鍋身冷時，可先預熱一下，食物烹煮效果會更佳。
8. 烹調加熱時，切勿碰觸鍋蓋或鍋體，以免燙傷；待玻璃鍋體冷卻後，始可碰觸。請勿讓小孩靠近。
9. 食物必須懸空放置於層架上及不能阻塞風道。
10. 煮食時，不要在容器內放入水或與其他不通風、不耐溫的器皿 (如塑膠) 共同使用，以免影響烹調效果。
11. 使用完畢後，請立即拔掉電源插頭。
12. 清潔煮食鍋機件前必須先拔下電源，待機件完全冷卻後方可進行。
13. 請勿將鍋蓋直接沖水或泡水清洗，可用扭乾之軟布擦拭污漬，不可用酒精或揮發性物質 (如去漬油等) 擦拭上鍋蓋。
14. 使用自動清洗功能時，適當水位為二、三分滿。
15. 清洗或烹調時，請避免碰撞玻璃鍋體，以免造成暗傷而導致破裂。
16. 光波爐鍋體與牆壁距離需大於10厘米。

注意事項

17. 本產品並不適宜讓兒童、身體或心智殘障、缺乏經驗或知識的人士操作，除非該人士得到負責保障其安全的人士的監管或指引。
18. 應避免8周歲以下兒童接觸電器、電源線。
19. 兒童未滿8周歲勿使用此電器，身體有缺陷、意識不清或有精神病者除非在專人監督下或經專門訓練能夠安全使用，否則請勿使用。禁止兒童把此電器當玩物。8周歲以上或有專人監督者方可清潔維護此電器。
20. 兒童必須被監督，切勿讓兒童使用、觸摸或把玩本機。
21. 如發現鍋蓋通電後有異聲或較大振動，切勿擅自打開鍋蓋，應先切斷電源，然後立即請專業技術人員或聯絡本公司進行維修。
22. 如電源線損壞或發生其他故障，切勿自行拆卸、修理或改裝，必須由本公司或合資格的專業技術人員更換和維修。
23. 請勿使用受損的電線或電源插頭，以防觸電、引起短路或火災。

產品結構

主機身

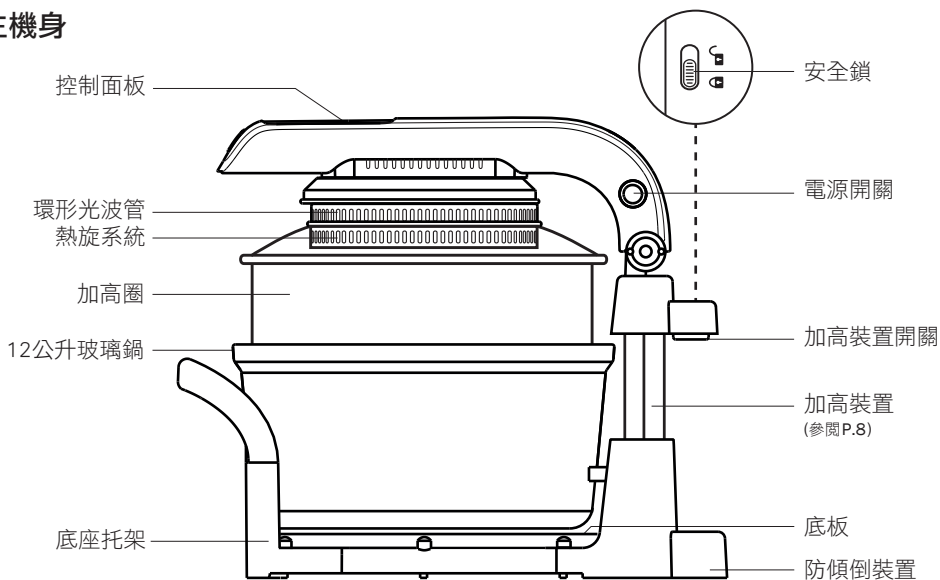

控制面板

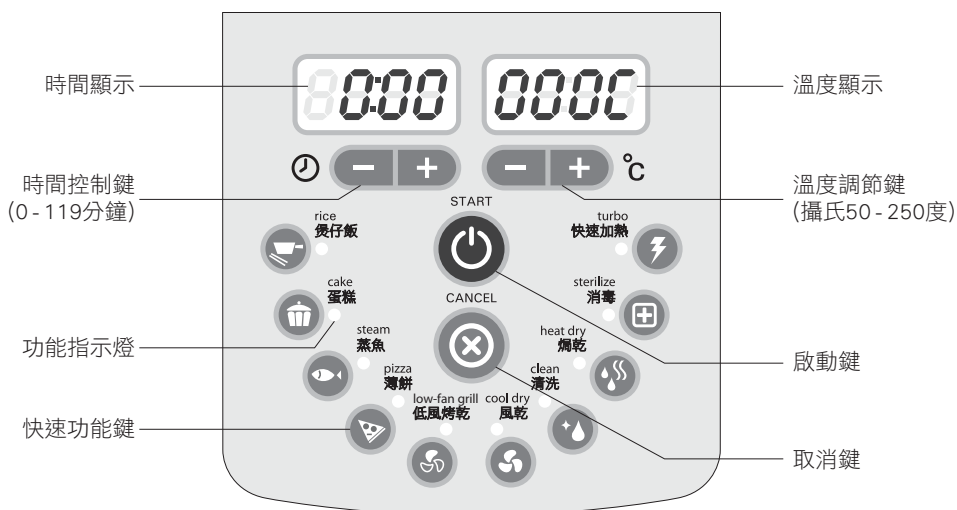

操作說明

注意：

- 使用過程中不可碰觸玻璃鍋，並切勿讓小孩靠近，以免燙傷。
- 如要使用食物或烹調器皿，請使用金屬材質器皿置於層架上，使食物能被全面烘烤而不必翻動，並與鍋蓋保持3公分以上之距離。
- 煮食進行期間，仍可調整溫度及時間。

基本操作

1. 底座托架水平放置。先把玻璃鍋從底座托架移走。

2. 把底板安裝在底座托架上，如圖1。

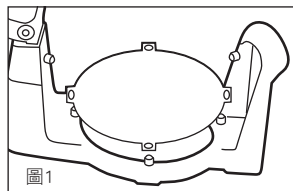

3. 將玻璃鍋放回底座托架，按實際需要自行選擇層架及配件並置於容器內，然後將食物放在層架上。

4. 將鍋蓋蓋好，然後接上電源。

5. 按鍋蓋側面的電源開關，開啟本機（圖2）。

註：當電源開啟後，控制面板上所有指示燈會亮起2秒，然後自動熄滅進入睡眠狀態。按任何按鍵即可恢復操作狀態。

6. 以下列其中一種方式設定烹調時間及溫度：

- 按照食物份量調校時間（0-119分鐘）及溫度（50-250°C）。
 - 選擇快速功能鍵（參閱P.8）。按鍵後可依個人喜好隨意增減時間及溫度。
- 註：指示燈閃動表示功能已被選擇，但煮食鍋仍未開始運作。

7. 按「啟動 」鍵開始烹調。

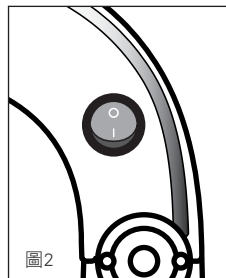

8. 若光波發熱管在設定時間完結之前熄滅，表示煮食鍋內溫度已達到預設溫度。此時煮食鍋進入了恆溫狀態，光波管會暫停加熱程序，但煮食鍋的熱旋系統會繼續運作，直至設定時間完結為止。

9. 完成烹調後（時間顯示為「0:00」），煮食鍋會發出數下聲響以作提示。用戶可拔下電源插頭，並打開鍋蓋。

- 若要在運作中暫停烹調，可直接將鍋蓋打開，光波管和熱旋系統會同時自動暫停運作；將上蓋放平，則恢復運作。
- 如欲在設定時間完結前提早結束運作，先按「取消 」鍵以取消整個烹調程序，然後再打開鍋蓋。

10. 利用取物夾把食物從玻璃容器中取出。

操作說明

快速功能鍵

快速功能鍵	預設時間值 / 溫度值	功能說明
 煲仔飯	30 分鐘 / 攝氏 250 度	專家按照個別食物之最佳烹調效果，預先設定不同烹調時間及溫度配搭。 (用戶亦可依個人喜好或食物份量隨意增減時間或溫度)。
 蛋糕	11 分鐘 / 攝氏 190 度	
 蒸魚	13 分鐘 / 攝氏 250 度	
 薄餅	3 分鐘 / 攝氏 250 度	
 低風烤乾	5 分鐘 / 攝氏 250 度	於短時間內以高熱將食物表面烤脆，特別適合翻熱已熟食物，使其口感更香脆；以低風運作，於烤脆芝麻等體積較小的食物時也不易四散。
 風乾	30 分鐘 / 攝氏 0 度	利用煮食鍋之熱旋系統，在不加熱情況下將食物高速風乾。
 清洗	10 分鐘 / 攝氏 250 度	利用光波發熱管配合熱旋系統，以均勻熱力迅速分解玻璃器皿內之食物殘漬。 * 註：請待煮食鍋完全冷卻後才注入清水(可加入適量洗潔精)。
 焗乾	6 分鐘 / 攝氏 90 度	以低熱力高速且均勻地烤焗，可去掉食物內多餘水份。
 消毒	13 分鐘 / 攝氏 130 度	以光波發熱管之熱力將食物或食具加熱，達至消毒效果。
 快速加熱	20 分鐘 / 攝氏 250 度	以最高溫度運作20分鐘。

加高裝置

- 將安全鎖(圖2A)推至解鎖位置，同時一邊向上按加高裝置開關(圖2B)，一邊將上蓋拉至最高位。
- 再在玻璃鍋上放上隨機的加高圈配件，即可增大容量，尤其適用於烤鴨、烤雞及多層煮食。

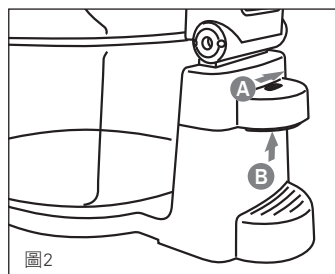

錯誤操作

切勿如下列圖示般使用煮食鍋：

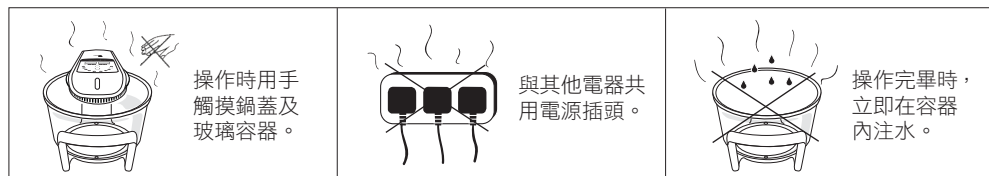

參考食譜

香燒豬頸肉

材料： 豬頸肉兩塊

調味料： 叉燒醬、麥芽糖、鹽和老抽適量

製作方法：

1. 所有調味料拌勻後加入豬頸肉，醃2-4小時。
2. 光波萬能煮食鍋以250 °C 預熱3分鐘。
3. 豬頸肉放於高架，使用加高圈燒10分鐘，反轉後再烤5分鐘即成。

焗蒜茸包

材料： 法式麵包一條、芝士粉少量、蒜粒（切成蒜蓉）、牛油各適量

製作方法:

1. 法式麵包切片。
2. 牛油加熱溶解後拌入蒜蓉，均勻地塗在法式麵包上（可灑上芝士粉增添香味）。
3. 預熱光波爐至 220 °C，再把法式麵包放入光波爐內烤3分鐘即可。

鹽燒三文魚頭

材料： 三文魚頭一個(切成兩塊，去腮)

調味料： 檸檬(半個榨汁)，鹽、紹興酒、麻油(各1茶匙)，糖、生粉(各2茶匙)，胡椒粉適量

製作方法：

1. 把所有調味料拌勻，醃三文魚頭半小時以上。
2. 魚頭置於光波爐內高架上，以250 °C 燒8分鐘。
3. 反轉後再燒5分鐘即可。

如欲獲取更多食譜，歡迎瀏覽德國寶網站 www.germanpool.com。

參考烹調時間

* 下列資料只供參考，實際烹調時間須視乎食物份量而稍作調整。



食物種類	參考時間 (分鐘)	參考溫度 (°C)
蝦	5 分鐘	250 °C
香腸	6 分鐘	200 °C
花生	6 分鐘	160-180 °C
麵包	8-10 分鐘	120-140 °C
蛋糕	8-10 分鐘	180-200 °C
蟹	10-13 分鐘	250 °C
魚類	10-15 分鐘	250 °C
龍蝦	12-15 分鐘	220-250 °C
叉燒	15 分鐘	250 °C
番薯	20-30 分鐘	250 °C
飯	30 分鐘	250 °C
雞	30-40 分鐘	250 °C



清潔與保養

1. 自動清洗功能：將適量清水(約1/5鍋體高度)注入鍋內，再加入少許中性清潔劑，按「 清洗」，即可自動清洗鍋內之油污。
2. 另一清洗方法是直接將玻璃鍋拆下，以海綿沾少許中性清潔劑，輕輕刷洗鍋身。
3. 如使用洗碗碟機，先將玻璃鍋拆下，將玻璃鍋及層架放入洗碗碟機清洗。切勿將上鍋蓋放入洗碗碟機。
4. 清潔煮食鍋機件前必須先拔下電源，待機件完全冷卻後方可進行。
5. 清洗時，請避免碰撞玻璃鍋體，以免造成暗傷而導致破裂。
6. 上鍋蓋因含電子部件，切勿用水浸泡清洗，玻璃鍋蓋請以扭乾的軟布抹拭即可。
7. 清潔容器、托架或配件時，可用含有溫和洗潔精的水進行清潔，但切勿於高溫中進行。
8. 清洗完畢後，以乾布拭乾鍋身及鍋蓋部位。

配件

隨機配件

<p>低架</p> 	<p>高低架</p> 	<p>取物夾</p> 
<p>適用於烹調較大型的食物 如：烤鴨、烤雞、燉湯、煲仔飯。</p>	<p>適用於需靠近發熱體的食物，亦可當 低架使用，或配合低架進行雙層煮食 如：串燒、叉燒、豬頸肉、雞翼。</p>	<p>用以取出器皿或食物，以防燙手。</p>

<p>加高圈</p> 	<p>煎碟</p> 	<p>烘盤</p> 
<p>用以增大容量5公升，尤其適用於 烤鴨、烤雞及多層煮食。</p>	<p>適用於煎餃子、煎魚、腸粉及 其他食物。</p>	<p>適用於烘焙細小的食物 如：花生、薯條、藥材、曲奇餅等。</p>

自選配件

<p>廚寶</p> 
<p>適用於焗飯、煲仔飯、焗蛋糕、 湯、麵等</p>

常見故障及處理

如遇以下一般性故障，請按以下指示處理，如仍處理不了或未發現故障原因時，請與本公司維修服務中心聯繫。

注意：為安全著想，再次特別提醒，請勿自行拆卸修理。

故障現象	處理方法
首次使用光波爐時出現冒煙情況。	- 於首次使用時，先以最高溫250°C空烤5分鐘，從而將機件保護油脂完全揮發出來
光波爐不運作。	- 檢查插頭是否已妥為插入插座和機身 - 確認上蓋已完全放下至水平位置 (註：上蓋掀起時，電源會自動關閉。)
光波爐不加熱。	- 檢查是否已調至較高的所需溫度
完成烹調，摩打風扇仍然轉動。	- 此乃為了散熱，約65秒後，風扇摩打便會自動停止 (註：若鍋內溫度超過180°C，仍會繼續轉動65秒。)
鍋蓋或玻璃鍋破損。	- 於本公司維修服務中心更換

技術規格

型號	CKY-882 / CKY-888
電壓	220 V
頻率	50 Hz
功率	1,300 W
溫度調節範圍	50 - 250 °C
時間控制範圍	1小時59分鐘
煮食鍋尺寸 (連底座)	(H) 306 mm (W) 330 mm (D) 476 mm
玻璃容器尺寸	(H) 167 mm (Ø) 330 mm
容器容量	12 L
淨重	7.48 kg

產品規格及設計如有變更，恕不另行通知。

中英文版本如有出入，一概以中文版為準。

本產品使用說明書以 www.germanpool.com 網上版為最新版本。

Table Of Contents

Notice Before Use	14
Product Structure	16
Operating Instructions	17
Suggested Recipes	19
Cook Time Reference	20
Care & Maintenance	20
Accessories	21
Troubleshooting	22
Technical Specifications	22
Warranty Terms & Conditions	23

Notice Before Use

Important

- For safety purpose, you should read the instructions carefully before using the appliance for the first time. Save the instructions for future reference.
- The appliance is designed for domestic use and may only be operated in accordance with these instructions for use.

1. Use a separate plug for the appliance. Do not overload power socket.
2. Before turning on the appliance, make sure it is plugged in and the lid is closed.
3. If the appliance is operated on a non-heat resistant table, place a heat-proof mat under the appliance before use.
4. The temperature of accessible surface may be high when the appliance is operating.
5. This appliance is intended to be used in household and similar applications such as:
 - staff kitchen areas in shops, offices and other working environments;
 - farm houses;
 - hotels, motels and other residential type environments;
 - bed and breakfast type environments.
6. This appliance is not intended to be operated by means of an external timer or a separate remote-control system.
7. When using the pot for the first time or when the glass container is cool, preheating will help to deliver better cooking results.
8. Do not touch the glass container during operation. Keep children away from the unit to prevent injuries.
9. Food must be placed on a rack inside the glass container. Make sure there is space between food and heating element, and interior airflow circulation should not be blocked.
10. Do not put water or plastic containers inside cooking pot during operation.
11. Unplug the cooking pot after use.

Notice Before Use

12. Unplug power cord and cool down cooking pot before cleaning or washing.
13. Wipe cooking pot cover with a soft and dry cloth. Do not rinse it with water. Do not clean it with alcohol or VOCs.
14. When using the “CLEAN” button for washing, pour water up to 20% or 30% of the pot level.
15. Avoid any form of tapping, knocking or striking against cooking pot in order to avoid damages.
16. There should be a distance of 10 cm between the appliance and the wall.
17. This appliance can be used by children aged from 8 years and above and persons with reduced physical, sensory or mental capabilities or lack of experience and knowledge if they have been given supervision or instruction concerning use of the appliance in a safe way and understand the hazards involved. Children shall not play with the appliance. Cleaning and user maintenance shall not be made by children unless they are older than 8 and supervised.
18. Keep the appliance and its cord out of reach of children less than 8 years.
19. The appliance is not intended for use by persons (including children) with reduced physical, sensory or mental capabilities, or any individual lacking experience and knowledge, unless they have been given supervision or instruction by a person responsible for their safety.
20. Children should be supervised to ensure that they do not play with the appliance.
21. When strange noise is heard or severe vibration occurs, do not open cooking pot cover. Unplug power immediately, and contact the manufacturer or a licensed technician for repair.
22. If the power cord is damaged, it must be replaced by the manufacturer, its service agent or similarly qualified persons in order to avoid a hazard.
23. Do not attempt to disassemble, repair or modify the appliance.

Product Structure

Unit Body

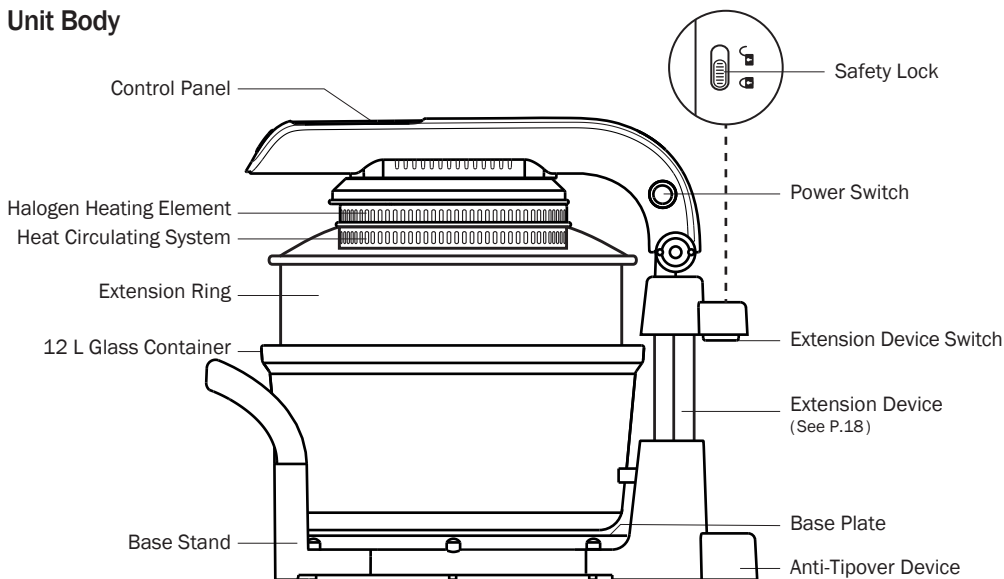

Control Panel

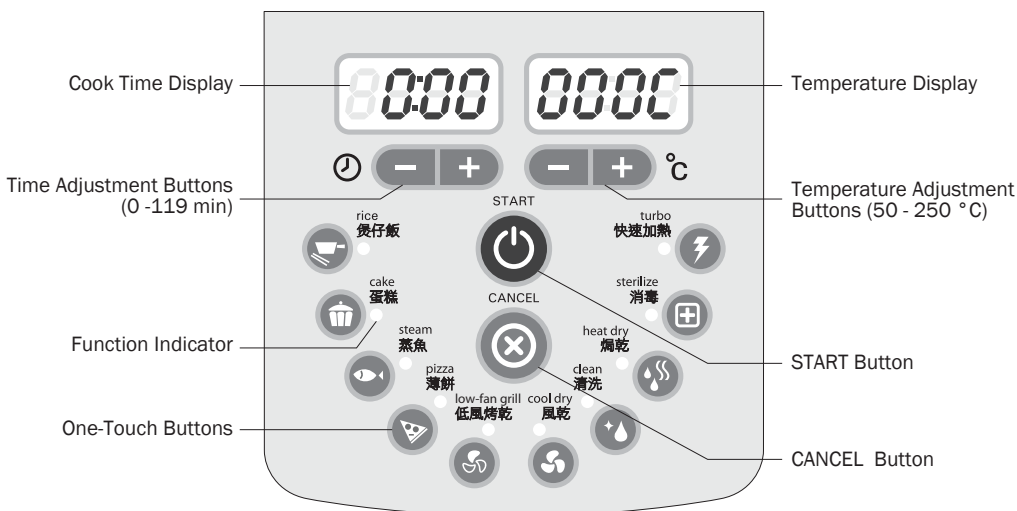

Operating Instructions

Attention:

- Do not touch the glass container during operation. Keep children away from the unit to prevent injuries.
- If a cookware is to be used inside glass container, use one that is made of metal and place it on a rack to ensure that food is evenly cooked. There should be a distance of at least 3 cm between the food and the lid.
- The cooking temperature and time can be adjusted during cooking.

Operating Procedures

1. Put the unit on a flat and level surface. Remove the glass container from the base stand.

2. Place the base plate on the base stand as Fig 1.
Note: The base plate is designed to ensure that the unit doesn't overheat the operating surface.

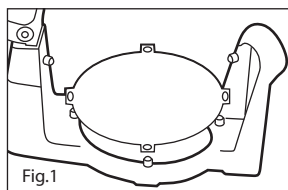

3. Place the glass container inside the base stand. Select appropriate rack and accessories based on food type and style of cooking. Position rack in glass container and place food items on top.

4. Secure pot cover. Then plug in power.

5. Turn on Power Switch (see Fig.2)

Note: When the power is turned on, all indicators on the control panel will light up for 2 sec. They will then turn off and the unit will enter sleep mode. Press any key to activate the unit.

6. Set cooking time and temperature using one of the following methods:

- Adjust time (0-119min) and temperature (50-250°C) by pressing "+" & "-" buttons.
- Select and press one of the one-touch function keys (see P.18).

User can make further adjustment using the "+" and "-" buttons.

Note: One of the function indicators will blink as soon as a function is selected; however, cooking pot will not start its operation until the "START" button is pressed.

7. Press "START"  button.

8. Heating element may go off before set time is up. It means that the desired temperature is reached. Cooking pot would temporarily stop adding heat. However, the heat circulating system would keep on running until time is completely over.

9. When time is over ("0:00"), cooking pot will beep several times. Unplug power and lift up cooking pot cover.





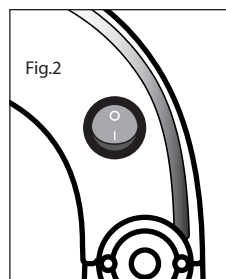





- Pause Cooking: Before set time is up, user can pause operation by simply lifting up the pot cover and resume cooking by closing it.
- Shut Down: To end cooking pot's operation before time is up, press "CANCEL"  and then lift up pot cover. Time and temperature settings will be erased.

10. Take food or plate out of glass container using the supplied plate lifter.



Operating Instructions

One-Touch Functions

One-Touch Function	Default Time / Temp.	Details
 Rice	30 min / 250 °C	Press to cook different food types at corresponding default time and temperature settings to achieve the best result. (User can further adjust time and temperature values according to personal preferences.)
 Cake	11 min / 190 °C	
 Steam	13 min / 250 °C	
 Pizza	3 min / 250 °C	
 Low-Fan Grill	5 min / 250 °C	Press to apply high heat to food within a short time. This function can create a crispy texture to the outer layer of food, with low fan speed setting ideal for tiny food items such as sesame.
 Cool Dry	30 min / 0 °C	Press to dry food without applying any heat.
 Clean	10 min / 250 °C	Fill cooking pot with appropriate amount of clean water and press this button to breakdown tough stains and grease in the glass container. * Note: please fill water (and detergent) after cooking pot completely cools down.
 Heat Dry	6 min / 90 °C	Press to dry food in high speed with low heat.
 Sterilize	13 min / 130 °C	Press to heat food or utensils for sterilizing purposes.
 Turbo	20 min / 250 °C	Press to operate cooking pot at the highest temperature setting for 20 minutes.

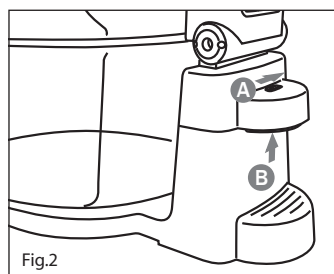

Extension Device

- Turn the safety switch (Fig.2A) to unlock position, while pressing the extension device button (Fig.2B) upward to release the lock and lifting the lid to expanded position at the same time.
- This way of increasing the capacity is ideal for grilling chicken and ducks and for multi-tier cooking.

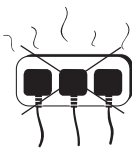

Incorrect Operation

Please do **NOT** :

	Touch cooking pot cover or glass container with hand during operation.		Overload power socket.		Pour water into container immediately after operation.
--	--	---	------------------------	---	--

Suggested Recipes

Roasted Pig's Cheek

Ingredients : Pig's Cheek

Seasoning : Char Siu Sauce, Malt Sugar, Salt and Dark Soy Sauce

Procedure :

1. Mix all seasoning ingredients together with pig's cheek, marinate for 2-4 hours.
 2. Preheat cooking pot at 250 °C for 3 min.
 3. Place meat on High Rack and grill for 10 min using Ring Extension; turn over and cook for another 5 min.
-

Garlic Bread

Ingredients : Baguette, Garlic, Butter, Cheese Powder (Optional)

Procedure :

1. Slice baguette into desired thickness.
 2. Mix minced garlic with melted butter spread mixture on sliced bread (Sprinkle cheese for extra flavour).
 3. Preheat cooking pot at 220 °C and toast garlic breads for 3 min.
-

Grilled Salmon Head

Ingredients : Salmon Head

Seasoning : Lemon Juice, Salt, Cooking Wine, Sesame Oil, Sugar, Corn Starch, Pepper

Procedure :

1. Mix seasoning ingredients together. Marinate fish for 30 min or more.
2. Grill salmon head at 250 °C in cooking pot using High Rack.
3. Turn over salmon head and grill for 5 min.

For more recipes, please visit German Pool website at www.germanpool.com.

Cook Time Reference

* Information provided below is for reference purpose only. Actual cooking time and temperature are subject to food portion.



FOOD TYPE	TIME (min)	TEMPERATURE (°C)
Shrimp	5 min	250 °C
Sausages	6 min	200 °C
Peanut	6 min	160-180 °C
Bread	8-10 min	120-140 °C
Cake	8-10 min	180-200 °C
Crab	10-13 min	250 °C
Fish	10-15 min	250 °C
Lobster	12-15 min	220-250 °C
BBQ Pork	15 min	250 °C
Sweet Potato	20-30 min	250 °C
Rice	30 min	250 °C
Chicken	30-40 min	250 °C

Care & Maintenance

1. To use the auto-cleaning function: Fill water up to 1/5 of the glass container. Add in mild detergent and press “ Clean” button.
2. Another method is to remove the glass container and use a sponge with mild detergent to wipe it clean.
3. If you wish to use a dishwasher, remove the glass container from its stand before dishwashing. Wash glass container and racks in the dishwasher, but do not wash the lid in a dishwasher.
4. Unplug power cord and cool down cooking pot before cleaning or washing.
5. While cleaning the cooking pot, avoid any form of tapping, knocking or striking against it, in order to avoid damages.
6. Since cooking pot cover comprises of electrical parts, do not immerse or rinse it with water. Wipe the cover with a soft and dry cloth.
7. Clean glass container, base stand and supplied accessories with mild detergent; cool down the entire cooking pot before any cleaning procedure.
8. After cleaning, wipe the glass container and pot cover with a dry cloth.

Accessories

Supplied Accessories

<p>Low Rack</p> 	<p>Dual Rack</p> 	<p>Plate Lifter</p> 
<p>For larger food items such as Grilled Duck, Grilled Chicken, Casserole, etc.</p>	<p>Allows food to be placed near heat source, e.g. Skewers; can be used simultaneously with low rack for multi-level cooking.</p>	<p>To carry food or plate in and out of cooking pot.</p>

<p>Ring Extension</p> 	<p>Frying Pan</p> 	<p>Baking Pan</p> 
<p>To increase cooking pot capacity by 5 L. Ideal for Grilled Duck, Grilled Chicken and multi-level cooking.</p>	<p>For Gyoza Dumplings, Fish, etc.</p>	<p>For baking small items such as Nuts, French Fries, Chinese Herbs, Cookies, etc.</p>

Optional Accessory

<p>Casserole Pot With Cover</p> 
<p>For Rice, Noodles, Soup, etc.</p>

Troubleshooting

If you encounter the following common troubles, please solve according to the following instructions. If the problem cannot be solved or a cause cannot be found, please contact our customer services centre.

Note: For safety purpose, do not dismantle the product for repair by yourself.

Phenomenon	Solution
Smoke is given out when using cooking pot for the first time.	- Operate at the highest temperature 260°C for 5 min without putting in food at the first time, for the protective grease to evaporate.
Cooking pot cannot be turned on.	- Check whether the power cord is properly plugged to both the socket and the unit body - Secure the lid by placing it down (Note: When the lid is not completely closed, the appliance will not turn on.)
Cooking pot does not heat up.	- Check whether the appliance is set to operate at a high enough temperature
Motor still operates after cooking.	- The purpose is to cool down the appliance. The fan will stop operating after 65 sec (Note: if the temperature inside glass container exceed 180°C, it will continue to operate for 65 sec.)
Lid or glass container is cracked.	- Order replacement at German Pool customer services centre

Technical Specifications

Model	CKY-882 / CKY-888
Voltage	220 V
Frequency	50 Hz
Power	1,300 W
Thermostat	50 - 250 °C
Timer	1hour59minutes
Cooking Pot Dimension (With Base Stand)	(H) 306 mm (W) 330 mm (D) 476 mm
Container Dimensions	(H) 167 mm (Ø) 330 mm
Capacity	12 L
Net Weight	7.48 kg

Specifications are subject to change without prior notice.

If there is any inconsistency or ambiguity between the English version and the Chinese version, the Chinese version shall prevail.

Refer to www.germanpool.com for the most up-to-date version of the Operating Instructions.

保用條款

此保用提供德國寶產品之機件在正常使用下壹年保用(自購買日起計算)。

Warranty Terms & Conditions

Under normal operations, the product will guarantee a 1-year full warranty provided by German Pool (effective from the date of purchase).

* 貴戶須在購機十天內，以下列其中一種方式向本公司登記資料，保用手續方正式生效：

1) 填妥本公司網頁內之保用登記表格

www.germanpool.com/warranty

2) 填妥保用登記卡，郵寄至本公司。



* This warranty is not valid until customer registration information is received by our Service Centre within 10 days of purchase via one of the following means:

1) Visit our website and register online:

www.germanpool.com/warranty

2) Complete all the fields on the attached Warranty Card and mail it back to our Customer Service Centre.



另請填妥以下表格並與正本發票一併保存，以便維修時核對資料。用戶提供之所有資料必須正確無誤，否則免費保用將會無效。 Please fill out the form below. This information and the original purchase invoice will be required for any repairs. Warranty will be invalidated if information provided is found to be inaccurate.

型號 Model No. : CKY-882 CKY-888

機身號碼 Serial No. : _____ 發票號碼 Invoice No. : _____

購買商號 Purchased From : _____ 購買日期 Purchase Date : _____

- 未能出示購買發票正本者，將不獲免費維修服務。
- 用戶應依照說明書的指示操作。本保用並不包括：
 - 上門安裝、檢驗、維修或更換零件之人工以及一切運輸費用；
 - 因天然與人為意外造成的損壞 (包括運輸及其他)；
 - 電源接合不當、不依說明書而錯誤或疏忽使用本機所引致之損壞。
- 於下列情況下，用戶之保用資格將被取消：
 - 購買發票有任何非認可之刪改；
 - 產品被用作商業或工業用途；
 - 產品經非認可之技術人員改裝或加裝任何配件；
 - 機身編號被擅自塗改、破壞或刪除。
- 總代理有權選擇維修或更換配件或其損壞部份。
- 產品一經被轉讓，其保用即被視作無效。

- Customer who fails to present original purchase invoice will not be eligible for free warranty service.
- Customer should always follow the operating instructions. This warranty does not apply to:
 - labour costs for on-site installation, check-up, repair, replacement of parts and other transportation costs;
 - damages caused by accidents of any kind (including material transfer and others);
 - operating failures resulting from applying incorrect voltage, improper usage, and unauthorized installations or repairs.
- This warranty is invalid if:
 - the purchase invoice is modified by an unauthorized party;
 - the product is used for any commercial or industrial purposes;
 - the product is repaired or modified by unauthorized personnel, or unauthorized parts are installed;
 - the serial number is modified, damaged or removed from the product.
- German Pool will, at its discretion, repair or replace any defective part.
- This warranty will be void if there is any transfer of ownership from the original purchaser.

客戶服務及維修中心

中國香港

九龍灣啟興道1-3號

九龍貨倉10樓

電話：+852 2333 6249

傳真：+852 2356 9798

電郵：repairs@germanpool.com

中國澳門

澳門俾利喇街145號

寶豐工業大廈3樓

電話：+853 2875 2699

傳真：+853 2875 2661

Customer Service & Repair Centre

Hong Kong, China

10/F, Kowloon Godown

1-3 Kai Hing Road, Kowloon Bay,

Kowloon, Hong Kong

Tel : +852 2333 6249

Fax : +852 2356 9798

Email : repairs@germanpool.com

Macau, China

3/F, Edificio Industrial Pou Fung,

145 Rua de Francisco Xavier Pereira,

Macau

Tel : +853 2875 2699

Fax : +853 2875 2661

此保用只適用於香港及澳門

This warranty is valid only in Hong Kong and Macau

GERMAN
POOL



德國寶

德國寶(香港)有限公司 German Pool (Hong Kong) Limited

中國香港 Hong Kong, China

香港九龍土瓜灣馬頭角道116號
新寶工商中心2期113號室

Room 113, Newport Centre Phase II, 116 Ma Tau
Kok Road, Tokwawan, Kowloon, Hong Kong.

電話 Tel: +852 2773 2888

傳真 Fax: +852 2765 8215

中國內地 Mainland China

廣東省佛山市順德區
大良南國東路德順廣場三層

3/F, Takshun Plaza, Nanguo East Road,

Shunde, Foshan, Guangdong

電話 Tel: +86 757 2980 8308

傳真 Fax: +86 757 2980 8318

中國澳門 Macau, China

澳門俾利喇街145號
寶豐工業大廈3樓

3/F, Edificio Industrial Pou Fung,

145 Rua de Francisco Xavier Pereira, Macau

電話 Tel: +853 2875 2699

傳真 Fax: +853 2875 2661



香港名牌十年成就獎
HONG KONG TOP BRAND TEN YEAR
ACHIEVEMENT AWARD



香港卓越名牌
HONG KONG
PREMIER BRAND



2007
CERTIFICATE AWARD FOR THE BEST BRAND ENTERPRISE
紅星品牌企業獎



中小企業
最佳拍檔大獎



© 版權所有。未獲德國寶授權，不得翻印、複製或使用本說明書作任何商業用途，違者必究。

© All rights reserved. Copying, reproducing or using the contents of this manual is not allowed without prior authorization from German Pool, violators will be prosecuted.

www.germanpool.com