

## Compact Instant Hot Water Dispenser | IWD-102



Online Warranty Registration



Please read these instructions and warranty information carefully before use and keep them handy for future reference.

# USER MANUAL

# Table of Contents

---

Warnings & Safety Precautions 03

Product Structure 05

Installation Instructions 06

Operation Instructions 07

Cleaning & Maintenance 09

Troubleshooting 09

Technical Specification 10

Warranty Terms & Conditions 19

# Warnings & Safety Precautions

---

## **WARNING!**

Read all instructions carefully before using this product.

- This product is for domestic indoor use only. If this product is used for any commercial, industrial, rental or other purposes, product warranty will be VOIDED.
- This product is not intended for use by children or persons with reduced physical, sensory or mental capabilities, or lack of experience and knowledge, unless they have been given supervision or instruction concerning use of this product by an adult responsible for their safety.
- Mind your children and DO NOT let children play with this product.
- Cleaning and user maintenance shall not be made by children without supervision.
- Check the voltage indicated on the rating label before using this product.
- If the supply cord is damaged, it must be replaced by the manufacturer, its service agent or similarly qualified persons in order to avoid hazards.
- Unplug this product from the power source before cleaning and maintenance.
- Contact German Pool authorized service technician for repair or maintenance of this product.

1. Please read this user manual thoroughly and keep it for future reference.
2. All contents of this manual are related to safety, and users must abide by them; the safety precautions in this manual only pertain to the correct use of this product; the precautions explain the danger, the degree of harm and possible accidents that might incur with improper use of this product.
3. DO NOT use parts and accessories not approved by the manufacturer; should malfunction occur due to use of improper parts and accessories, product warranty will be voided.
4. After unwrapping this product, check to make sure if it is damaged in any way, and if any of its parts and accessories are missing.
5. To avoid the danger of suffocation, keep all plastic wrappings away from infants and children.
6. This product is only suitable for use with purified water between 5-38°C.
7. DO NOT use this product to heat beverages, oil, detergents or similar liquids.
8. Use a light hand when handling this product to avoid dropping it and causing injuring or damage to the product.
9. This product must be kept out of reach of children and pets.
10. Children and incapacitated persons must be supervised by guardians when using this product.
11. This product must be placed in a cool and ventilated place away from direct sunlight. DO NOT place this product near heaters, heat-producing electrical appliances or other high temperature environments.
12. DO NOT place this product in an environment where flammable gas leakage will or may occur.
13. DO NOT insert or unplug the power plug with wet hands, in order to avoid the danger of electric shock.
14. DO NOT dismantle this product or its parts by yourself to avoid causing water leakage or damage to this product.
15. If this product will not be used for a prolonged period of time, disconnect it from the power source and empty out any residual water left inside the product.
16. This product must be used with a reliably earthed 3-pin socket.
17. Before using this product for the first time, or re-using it after it has been left idle for a long period of time, please clean the internal waterway thoroughly before use.

# Warnings & Safety Precautions

---

18. Use only soft damp cloth to clean this product, DO NOT use gasoline or other organic solvents to wipe this product to avoid causing discoloration or rust, and DO NOT rinse the main unit with water.
19. Should this product show malfunction, disconnect the water source and power source immediately, and contact German Pool Customer Service & Repair Centre.
20. Due to continuous improvement and update of products and technologies, the product model, appearance, technical parameters mentioned in this user manual may differ slightly from the actual product itself without prior notice. If there is any change, please refer to the actual product itself.
21. It is recommended that this product be used in an environment below 1200m altitude.
22. After heating, a small amount of water may dribble out of the spout, this is a normal phenomenon. Please take care not to get scalded.
23. When installing the water tank to the main unit of this product, the pressure may cause a small amount of water to dribble out of the spout. This is a normal phenomenon.
24. If power cord is damaged, it must be replaced by German Pool Customer Service & Repair Centre. To avoid fire hazard, DO NOT modify the power plug or lengthen the power cord by yourself.
25. DO NOT disassemble this product by yourself or by any unauthorized personnel, as improper repair may cause danger.
26. If the above precautions are not strictly followed, our company shall not be held responsible for any resulting consequences.

# Product Structure

---

## Main Body

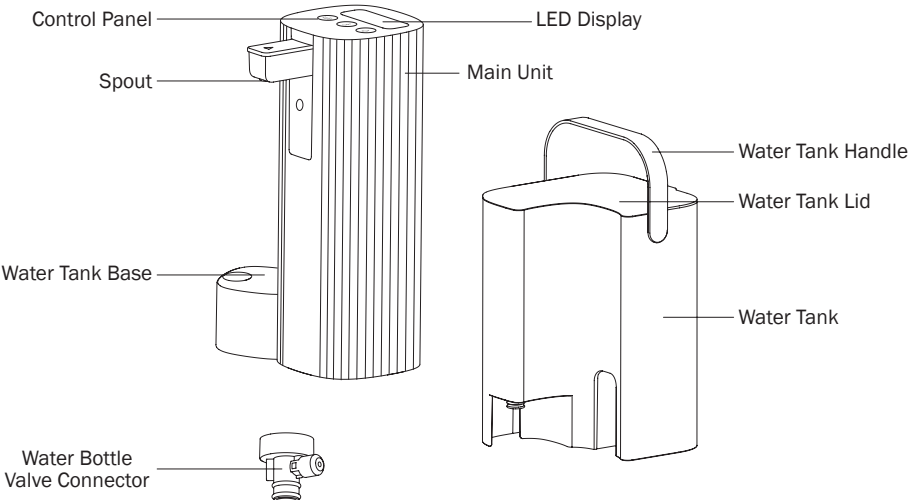

# Installation Instructions

---

1. Take the main unit and water tank out of the box.
2. Pull out the water tank base, and lift the spout to the horizontal position.
3. Plug the power cord into the main unit and connect to the power source.
4. Attach the water tank or water pipe or water bottle valve connector depending on your water source.

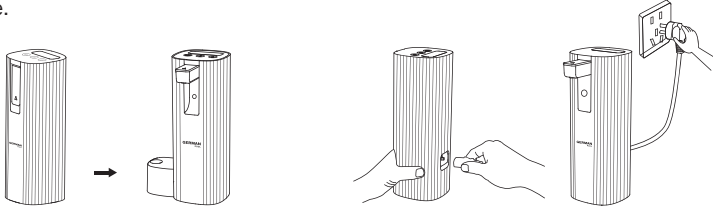

## Using The Water Tank

1. Fill up the water tank (DO NOT exceed the 2L max. water mark), and put on the water tank lid.
2. Attach the water tank securely to the water tank base on the main unit.

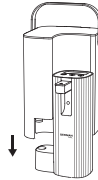

## Using The Water Pipe

1. Attach the water pipe to the water tank base of the main unit.
2. Dip the other end of the water pipe into your water bottle or water container.

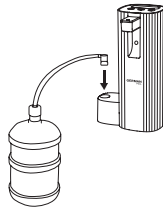

## Using The Water Bottle Valve Connector

1. Screw the water bottle valve connector onto your water bottle.
2. Attach the water bottle upside down onto the water tank base.



## Note:

Check to make sure water tank, water pipe or water bottle valve connector is securely attached to the water tank base in order to avoid water leakage, air bubbles or erroneous empty water tank alert.

# Operation Instruction

## Control Panel

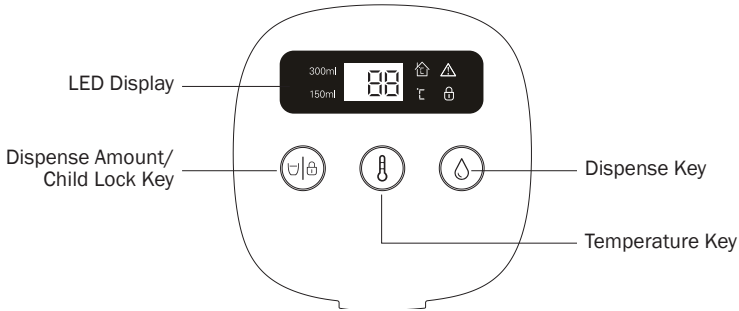

Icon	Function	Icon	Function
	<p>Dispense Amount/Child Lock Key</p> <ul style="list-style-type: none"> <li>Tap and hold key for 2 seconds to unlock Child Lock</li> <li>Tap and hold key for 10 seconds to activate or deactivate Child Lock Function</li> <li>Tap key to switch between dispensing amount of 300ml or 150ml</li> </ul>		<p>Temperature Display</p> <p>Display your selected temperature</p>
	<p>Temperature Key</p> <p>Tap key repeatedly to select water-dispensing temperature of room temperature, 45°C, 55°C, 65°C, 75°C, 85°C and 99°C</p>		<p>Room Temperature Water Indicator Light</p> <p>When this indicator light is lit, it means the water dispensed will be at room temperature</p>
	<p>Dispense Key</p> <ul style="list-style-type: none"> <li>Tap key to dispense water (Child Lock must be unlocked)</li> <li>If Child Lock is locked, tapping this key will yield no response</li> <li>Tap and hold key for 5 seconds to release all residual water in the water tank</li> </ul>		<p>Empty Water Tank Indicator Light</p> <p>When this indicator light blinks, it means the water tank is empty</p>
150ml 300ml	<p>Dispense Amount Indicator</p> <p>Shows the selected water amount to be dispensed</p>		<p>Child Lock Indicator Light</p> <ul style="list-style-type: none"> <li>When this indicator light is lit, it means Child Lock is locked</li> <li>When this Indicator Light turns off, it means Child Lock is unlocked</li> </ul>





### Note:

- Use only purified water as the water source.
- Make sure the spout is lifted to the horizontal position before dispensing water.



# Operation Instruction

---

## How To Use

1. Tap Dispense Amount/Child Lock Key  to switch between dispensing amount of 150ml or 300ml.
2. Tap Temperature Key  repeatedly to select water-dispensing temperature of room temperature, 45°C, 55°C, 65°C, 75°C, 85°C and 99°C.
3. Tap and hold Dispense Amount/Child Lock Key  for 2 seconds to unlock Child Lock; Child Lock Indicator Light  turns off (no need to unlock Child Lock if selecting room temperature water).

### Note:

- If product does not receive any command in 10 seconds, Child Lock will automatically relock.
- To deactivate Child Lock Function, tap and hold Dispense Amount/Child Lock Key  for 10 seconds. After Child Lock Function is deactivated, it will not automatically re-lock after dispensing, and the product will automatically reset the dispensing temperature back to room temperature.
- To reactivate Child Lock Function, tap and hold Dispense Amount/Child Lock Key  for 10 seconds again.

4. After selecting water temperature and dispense amount, tap Dispense Key  to start dispensing water.

### Note:

When water is being dispensed, tapping any key will immediately stop the water from dispensing.

## Sleep Mode

If the product does not receive any command in 1 minute, it will automatically enter Sleep Mode, Child Lock Indicator Light  on the LED Display will light up constant, and all other indicator lights will turn off.

## Empty Water Tank Indicator Light

When the product detects that the water tank is empty, Empty Water Tank Indicator Light  will blink in red, buzzer will buzz 3 times and product will not dispense water. Please refill water tank immediately.

## How To Release Residual Water

If user wishes to move this product or take it outdoors, please release all the residual water in the product first:

1. Connect the power source and lift the spout to the horizontal position, then tap and hold Dispense Key  for 5 seconds to dispense all the residual water inside the main unit.
2. Tilt the main unit left and right to let any remaining water drip out from the spout.
3. Repeat steps 1 and 2 until no water drips out from the spout.



# Cleaning and Maintenance

## ⚠ WARNING!

- Unplug product from the power source and allow product to cool down completely before commencing cleaning and maintenance.
  - DO NOT immerse or rinse the main unit and power cord with water, or allow these parts to get wet.
1. The main unit can only be wiped with only soft damp cloth, DO NOT use gasoline or other organic solvents to wipe this product to avoid causing discoloration or rust. DO NOT rinse the main body with water.
  2. The water tank can be rinsed with water.

# Troubleshooting

Problem	Possible Cause	Solution
LED display does not light up	Power is not connected	Check if the power cord is properly plugged in
Product does not heat	Temperature sensor open circuit	Contact German Pool Customer Service & Repair Centre
	Heating element is damaged	
	Main control board is damaged	
Product leaks water	Silicone tube is not properly attached	Attach the tube properly
	One of the water-contacting parts inside the main unit is damaged	Contact German Pool Customer Service & Repair Centre
Current leakage and you feel a tingling sensation when touching the product	Power cord is damaged	Contact German Pool Customer Service & Repair Centre
LED display shows "EE"	Silicon-controlled rectifier over-temperature	Contact German Pool Customer Service & Repair Centre
LED display shows "E2"	Water dispense temperature sensor malfunction	Contact German Pool Customer Service & Repair Centre
LED display shows "E5"	Dry burn over-temperature warning	Refill tank with room temperature water or wait till the heating element recovers automatically; if product does not recover, contact German Pool Customer Service & Repair Centre
LED display shows "EU"	Communication warning	Contact German Pool Customer Service & Repair Centre

## ⚠ WARNING!

If problem persists, discontinue use immediately and contact German Pool Customer Service & Repair Centre for inspection and repair.

# Technical Specification

---

Model	IWD-102
Voltage	220 V
Frequency	50 Hz
Power	1600 W
Water Tank Capacity	2000 ml
Product Dimensions	(H) 220 (W) 157 (D) 204 mm
Net Weight	1.3 kg

- Specification is subject to change without prior notice.
- If there is any inconsistency or ambiguity between the English version and the Chinese version, the Chinese version shall prevail.
- Refer to [www.germanpool.com](http://www.germanpool.com) for the most update version of the user manual.

# 目錄

---

警告及注意事項 12

產品結構 13

安裝說明 14

使用說明 15

清潔與保養 17

故障檢修 17

技術規格 18

保用條款 19

# 警告及注意事項

## ⚠ 警告！

使用本產品前，請仔細閱讀所有說明。

- 本產品只限家居室內日常使用，如產品作任何商業、工業、出租或其他用途，保用證即告失效。
- 請勿讓兒童或身體有殘障、精神不健全及對本產品缺乏經驗或知識的人士單獨使用本產品；如需使用，必須要在負責任的成年人監管下方可使用。
- 應照顧好兒童，確保他們不會玩耍本產品。
- 無成年人監管下，勿讓兒童清潔及維護本產品。
- 使用前，請先檢查所有電壓是否與本產品標籤上的電壓相符。
- 如果電源線損壞，為免發生意外，電源線必須由廠方、廠方指定的維修中心或同等合格的技術人員進行更換。
- 清潔或檢查本產品前，必須先關機及拔掉插頭。
- 請聯繫德國寶授權的技術人員進行維修或保養本產品。

1. 使用前請仔細閱讀並妥善保管本說明書。
2. 本說明書所有內容均與安全有關，用戶必須遵守；本說明書中的注意事項只是為了正確地使用本產品；注意事項中解釋了危險、危害的程度大小及可能發生的事故。
3. 嚴禁使用未經廠商許可的其他配件，若因此造成本產品故障，保養將自動終止。
4. 在拆除包裝後檢查本產品是否有損傷，核對配件是否齊全。
5. 為避免窒息危險，必須將塑膠袋遠離嬰兒及兒童。
6. 本產品適用水源為純淨水，適用水溫為5-38°C。
7. 嚴禁加熱飲料、油、洗滌劑等液體。
8. 必須注意輕拿輕放，以免本產品跌落造成砸傷。
9. 本產品必須放在兒童及寵物無法觸及的地方。
10. 兒童及無行為能力人士必須在監護人監督下使用本產品。
11. 本產品必須放置於室內陰涼乾燥的地方，避免陽光直射，擺放位置不得嚴近暖氣設備、電熱產品或其他高溫場所。
12. 本產品擺放位置不得處於會出現或有可能出現可燃性氣體洩露的場所。
13. 嚴禁用濕手插拔電源插頭，以免引發觸電危險。
14. 嚴禁自行拆卸本產品上的零部件，以防機器漏水或受損。
15. 長期不使用本產品，務必斷開電源，排空本產品中的水。
16. 本產品必須使用有可靠接地的三腳插座。
17. 初次使用或長期停用後，必須對內部水路進行清洗，清洗完畢後方可使用。
18. 本產品清潔必須使用柔軟的濕棉布擦拭，嚴禁用汽油等有機溶液擦拭機身，避免本產品表面褪色或產生銹蝕，嚴禁用水沖洗機身。
19. 本產品出現故障時，必須立即切斷水源及電源，並聯繫德國寶客戶服務及維修中心。
20. 由於產品和技術不斷改進和更新，本說明書中涉及到的產品型號、外觀、技術參數和實物可能略有不同，若有變化，請以實物為準，恕不另行通知。
21. 本產品建議在海拔高度不高於1200米的地區使用。
22. 本產品加熱結束後，會有少量餘水流出，屬於正常現象，必須注意防止燙傷。
23. 本產品安裝水箱時，出水口由於受力會有少量水流出，屬於正常現象。
24. 如果電源線損壞，必須由德國寶客戶服務及維修中心進行更換。嚴禁改裝電源插頭或自行加長電源線，以免導致火災。
25. 嚴禁自行拆解維修本產品或交由非授權人員維修，因不當維修可能造成危險。
26. 如未按上述注意事項操作所造成的後果，本公司將不承擔任何責任。

# 產品結構

## 主機

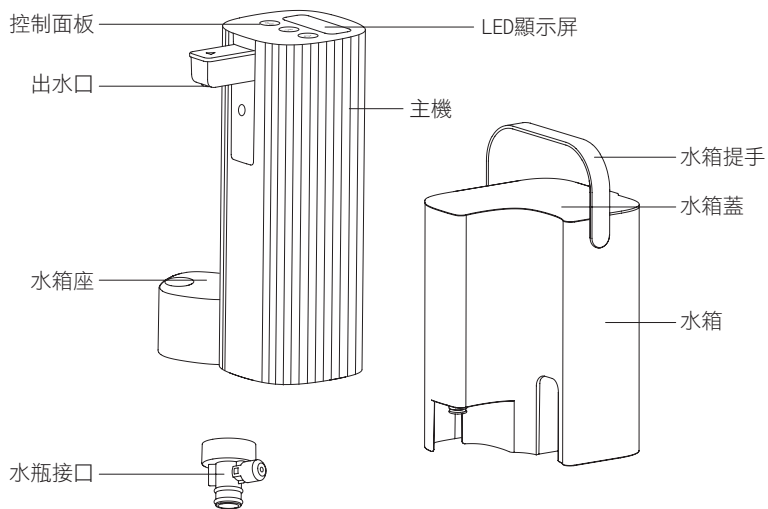

# 安裝說明

1. 從包裝中取出主機及水箱。
2. 將主機下方的水箱座拉出，並將出水口打開至水平狀態。
3. 將電源線連接到主機，並插上電源。
4. 使用水箱，或根據不同的水源使用水管或水瓶接口。



## 使用水箱

1. 將水箱裝滿水後（注水時嚴禁超過2L水位線），蓋上水箱蓋。
2. 將水箱正確安裝在主機的水箱座上。

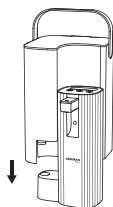

## 使用水管

1. 將水管安裝在主機的水箱座上。
2. 將水管另一端放入桶裝水或其他裝水容器中。

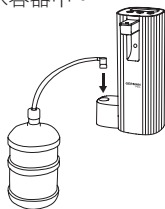

## 使用水瓶接口

1. 將水瓶接口擰在合適的水瓶上。
2. 將水瓶正確安裝在主機的水箱座上。

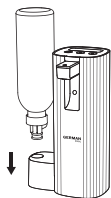







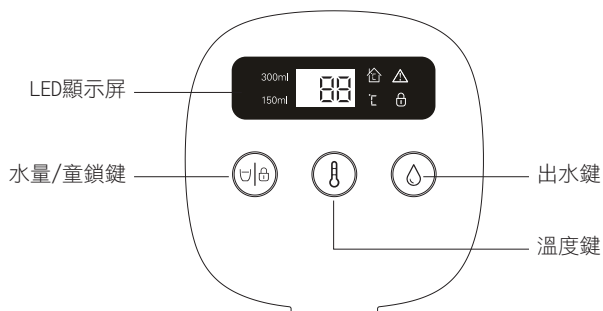

## 注意：

必須確保水箱、水管或水瓶接口已穩固安裝好，避免漏水、噴氣或錯誤顯示缺水。

# 使用說明

## 控制面板







圖標	說明	圖標	說明
	水量/童鎖鍵 <ul style="list-style-type: none"> <li>長按 2 秒解除童鎖</li> <li>長按 10 秒取消童鎖或啟用童鎖</li> <li>短按循環選擇 300 毫升或 150 毫升出水量</li> </ul>		溫度顯示 顯示所選溫度
	溫度鍵 按鍵循環選擇室溫、45、55、65、75、85 及 99°C 出水溫度		室溫水指示燈 指示燈常亮表示出水為室溫
	出水鍵 <ul style="list-style-type: none"> <li>解除童鎖後按此鍵出水</li> <li>如未解除童鎖，按此鍵無反應</li> <li>長按 5 秒進入排水模式</li> </ul>		缺水指示燈 指示燈閃爍表示水箱缺水
150ml 300ml	水量顯示 顯示所選水量		童鎖指示燈 <ul style="list-style-type: none"> <li>指示燈常亮表示童鎖啟用中</li> <li>指示燈熄滅表示已解除童鎖</li> </ul>

### 注意：



- 必須以純淨水作為進水水源。
- 使用前必須確保出水口打開至水平狀態。

# 使用說明

## 使用步驟

1. 按水量/童鎖鍵  循環選擇150毫升或300毫升出水量。
2. 按溫度鍵  循環選擇室溫、45、55、65、75、85或99℃出水溫度。
3. 長按水量/童鎖鍵  2秒解除童鎖，童鎖指示燈  熄滅（如選擇室溫，毋須解除童鎖）。

## 注意：

- 如10秒內無任何操作或取水後，自動重新啟用童鎖。
- 如要取消童鎖，長按水量/童鎖鍵  10秒。取消童鎖後，每次取水後童鎖將不會自動啟用，並自動將水溫調為室溫。
- 如要重新啟用童鎖，再長按水量/童鎖鍵  10秒。

4. 完成設置後，按出水鍵開始出水。

## 注意：

取水期間，按任何鍵可停止出水。

## 休眠模式

如在1分鐘內無任何操作，產品將自動進入休眠模式，此時LED顯示屏的童鎖指示燈  常亮，其餘指示燈熄滅。

## 缺水提示

當產品檢測到水箱缺水時，缺水指示燈  以紅色閃爍，蜂鳴器發出提示聲3聲，此時無法取水，請即為水箱添水。

## 排水方法

如需移動本產品，或將本產品攜帶外出使用，請先進行排水：

1. 接通電源後打開出水口，長按出水鍵  5秒進行排水。
2. 然後左右傾斜機身，讓機體內殘餘的水從出水口排出。
3. 重複此步驟直至無水排出為止。



# 清潔與保養

## ⚠ 警告！

- 在清潔及維護本產品前，必須先拔除插頭並讓產品完全冷卻。
  - 嚴禁將機身或電源線浸入水中，或讓水分接觸這些部件。
1. 主機體清潔必須使用柔軟的濕棉布擦拭，嚴禁用汽油等有機溶液擦拭機身，避免本產品表面褪色或產生銹蝕，嚴禁用水沖洗機身。
  2. 水箱可以用水沖洗。

# 故障檢修

故障現象	可能原因	處理方法
顯示屏不亮	電源未接通	檢查插頭是否插好
不加熱	溫控器斷開	聯絡德國寶客戶服務及維修中心
	加熱體損壞	
	主控板損壞	
漏水	產品內部涉水部件損壞	扎緊硅膠管
	硅膠管未扎緊	聯絡德國寶客戶服務及維修中心
漏電及機身帶感應電	電源線損壞	聯絡德國寶客戶服務及維修中心
顯示屏顯示「EE」	可控硅超溫	聯絡德國寶客戶服務及維修中心
顯示屏顯示「E2」	出水溫度傳感器故障	聯絡德國寶客戶服務及維修中心
顯示屏顯示「E5」	乾燒超溫警告	放室溫水或等待加熱體自動恢復即可正常使用，如無法恢復，聯絡德國寶客戶服務及維修中心
顯示屏顯示「EU」	通訊警告	聯絡德國寶客戶服務及維修中心

## ⚠ 警告！

如故障持續，立即停止使用，並聯絡德國寶客戶服務及維修中心作出檢查及維修。

# 技術規格

---

<b>型號</b>	<b>IWD-102</b>
電壓	220 V
頻率	50 Hz
功率	1600 W
水箱容量	2000 ml
產品尺寸	(H) 220 (W) 157 (D) 204 mm
淨重	1.3 kg

- 產品規格及設計如有變更，恕不另行通知。
- 中英文版本如有出入，一概以中文版為準。
- 本產品使用說明書以[www.germanpool.com](http://www.germanpool.com)網上版為最新版本。

# 保用條款

此保用提供德國寶產品之機件在正常使用下壹年保用(自購買日起計算)。

# Warranty Terms & Conditions

Under normal operations, the product will guarantee a 1-year warranty provided by German Pool (effective from the date of purchase).

\* 貴戶須在購機十天內，以下列其中一種方式向本公司登記資料，保用手續方正式生效：

- 1) 填妥德國寶VIP手機應用程式保用登記表(掃描右方二維碼)
- 2) 填妥本公司網頁保用登記表  
[www.germanpool.com/warranty](http://www.germanpool.com/warranty)
- 3) 填妥保用卡郵寄至本公司。



\* This warranty is not valid until customer registration information is received by our Service Centre within 10 days of purchase via one of the following means:

- 1) Visit our VIP App and register online:  
(Scan the QR Code on the right)
- 2) Visit our website and register online:  
[www.germanpool.com/warranty](http://www.germanpool.com/warranty)
- 3) Complete the attached Warranty Card and mail it back to our Customer Service Centre.



另請填妥以下表格並與正本發票一併保存，以便維修時核對資料。用戶提供之所有資料必須正確無誤，否則免費保用將會無效。 Please fill out the form below. This information and the original purchase invoice will be required for any repairs. Warranty will be invalidated if information provided is found to be inaccurate.

型號 Model No. : IWD-102

機身號碼 Serial No. : \_\_\_\_\_ 發票號碼 Invoice No. : \_\_\_\_\_

購買商號 Purchased From : \_\_\_\_\_ 購買日期 Purchase Date : \_\_\_\_\_

1. 未能出示購買發票正本者，將不獲免費維修服務。
2. 用戶應依照說明書的指示操作。本保用並不包括：
  - 上門安裝、檢驗、維修或更換零件之人工以及一切運輸費用；
  - 因天然與人為意外造成的損壞(包括運輸及其他)；
  - 電源接合不當、不依說明書而錯誤或疏忽使用本機所引致之損壞。
3. 於下列情況下，用戶之保用資格將被取消：
  - 購買發票有任何非認可之刪改；
  - 產品被用作商業或工業用途；
  - 產品經非認可之技術人員改裝或加裝任何配件；
  - 機身編號被擅自塗改、破壞或刪除。
4. 總代理有權選擇維修或更換配件或其損壞部份。
5. 產品一經被轉讓，其保用即被視作無效。

1. Customer who fails to present original purchase invoice will not be eligible for free warranty service.
2. Customer should always follow the operating instructions. This warranty does not apply to:
  - labour costs for on-site installation, check-up, repair, replacement of parts and other transportation costs;
  - damages caused by accidents of any kind (including material transfer and others);
  - operating failures resulting from applying incorrect voltage, improper usage, and unauthorized installations or repairs.
3. This warranty is invalid if:
  - the purchase invoice is modified by an unauthorized party;
  - the product is used for any commercial or industrial purposes;
  - the product is repaired or modified by unauthorized personnel, or unauthorized parts are installed;
  - the serial number is modified, damaged or removed from the product.
4. German Pool will, at its discretion, repair or replace any defective part.
5. This warranty will be void if there is any transfer of ownership from the original purchaser.

## 客戶服務及維修中心

### 中國香港

九龍大業街59號

三湘九龍灣貨運中心地下B室

電話：+852 2333 6249

傳真：+852 2356 9798

電郵：repairs@germanpool.com

### 中國澳門

澳門青洲大馬路(青洲新路)

515號美居廣場第二期1樓A座

電話：+852 2875 2699

傳真：+852 2875 2661

## Customer Service & Repair Centre

### Hong Kong, China

Unit B, G/F, Sunshine Kowloon Bay

Cargo Centre, 59 Tai Yip Street

Kowloon, Hong Kong

Tel : +852 2333 6249

Fax : +852 2356 9798

Email : repairs@germanpool.com

### Macau, China

A, 1 Andar, Mei Kui Kuong Cheong Fase 2,

No.515 Avenida Do Conselheiro Borja

Macau

Tel : +853 2875 2699

Fax : +853 2875 2661

此保用只適用於香港及澳門

This warranty is valid only in Hong Kong and Macau

## German Pool (Hong Kong) Limited

### Hong Kong, China

Room 113, Newport Centre Phase II, 116 Ma Tau  
Kok Road, Tokwawan, Kowloon, Hong Kong.  
Tel: +852 2773 2888  
Fax: +852 2765 8215

### Mainland China

8th, Xinxiang Road, Wusha Industrial Park,  
Daliang, Shunde, Foshan, Guangdong  
Tel: +86 757 2219 6888  
Fax: +86 757 2219 6809

### Macau, China

A, 1 Andar, Mei Kui Kuong Cheong Fase 2,  
No.515 Avenida Do Conselheiro Borja, Macau  
Tel: +853 2875 2699  
Fax: +853 2875 2661



香港《S MARK》  
安全認證



中國櫥櫃/家電行業  
十大影響力品牌

CEO

CEO非凡品牌大賞



香港優質商標



香港工商業獎



2007  
最具潛質  
創星品牌企業獎



香港中小企業  
最佳拍攝大獎



香港消費者推祟品牌



香港《心嚮》  
優質服務證書



香港名牌十年成就獎  
HONG KONG TOP BRAND TEN YEAR  
ACHIEVEMENT AWARD

© All rights reserved. Copying, reproducing or using the contents of this manual is not allowed without prior authorization from German Pool, violators will be prosecuted.