

Mini Korean Barbecue Grill | KQB-39E



Online Warranty Registration



Please read these instructions and warranty information carefully before use and keep them handy for future reference.

USER MANUAL

請即進行保用登記!

有關保用條款細則，請看本說明書最後一頁。

Please register your warranty information now!

For Warranty Terms & Conditions,
please refer to the last page of this user manual.

Table of Contents

Warnings & Safety Precautions	04
Product Structure	05
Operation Instructions	06
Care & Maintenance	08
Technical Specifications	08
Warranty Terms & Conditions	15

Warnings & Safety Precautions

WARNING!

Read all instructions carefully before using this product.

- This product is for domestic indoor use only. If this product is used for any commercial, industrial, rental or other purposes, product warranty will be VOIDED.
- This product is not intended for use by children or persons with reduced physical, sensory or mental capabilities, or lack of experience and knowledge, unless they have been given supervision or instruction concerning use of this product by an adult responsible for their safety.
- Mind your children and DO NOT let children play with this product.
- Cleaning and user maintenance shall not be made by children without supervision.
- Check the voltage indicated on the rating label before using this product.
- If the supply cord is damaged, it must be replaced by the manufacturer, its service agent or similarly qualified persons in order to avoid hazards.
- Unplug this product from the power source before cleaning and maintenance.
- Contact German Pool authorized service technician for repair or maintenance of this product.

1. This product is for indoor use only.
2. During operation, this product must be placed on a level and sturdy countertop, and DO NOT tilt this product.
3. Keep this product at least 50cm away from walls during operation.
4. This product can only be used with a reliably grounded 3-pin plug socket. DO NOT share socket with other appliances.
5. During operation, keep this product away from things that may catch fire or explode.
6. During operation, the heat-emitting part or surface of this product will become hot, be careful not to get burnt.
7. During operation, DO NOT leave this product unattended.
8. DO NOT let children or persons with reduced mental capability use or operate this product.
9. Unplug this product from the socket before cleaning, or when product is not in use.
10. DO NOT repair this product by yourself. Repair can only be made by qualified professional technicians.
11. If the power cord is damaged, stop using this product immediately, and DO NOT re-use until it has been replaced with a power cord designated for this product.
12. DO NOT splash or immerse this product in water.
13. If this product will not be used for a prolonged period of time, disconnect it from the power source.
14. DO NOT operate this product with means of an external timer or remote control system.
15. DO NOT use charcoal or other similar fuels with this product.
16. A heat-proof pad must be placed underneath this product if your table is not heat-resistant.
17. During cooking and heating, DO NOT touch this product to avoid getting burnt, and DO NOT let children near this product.
18. DO NOT use aluminum foil or cling film with this product, as the heat from the infrared light may cause the foil or film to catch fire.

Warnings & Safety Precautions

19. When cooking different kinds of food together (water content from seafood and oil content from meat, etc.), oil spitting may occur which may cause bodily injury or product damage or even fire. DO NOT cook continuously at high temperature.
20. When there is no food on the product, DO NOT set the product to a temperature higher than necessary, otherwise it may lead to product discoloration, deformation or damage, or even cause a fire.
21. DO NOT block the exhaust vent of this product.
22. The immediate area surrounding the heating parts is hot, be extra cautious not to get burnt.
23. DO NOT stare at the halogen heating element (infrared light) as it may lead to temporary dizziness, eye discomfort, etc.
24. When this product is in use or in the short time after it has been turned off, the top, bottom and surrounding area of the product will be hot; items that may become deformed by heat or items that may catch fire should be kept away in order to avoid fire hazard.
25. During cooking, if user wishes to add, retrieve or flip over food items, pivot the swing arm 60° to the left or right.
26. During operation, the vertical arm of this product becomes hot, DO NOT touch the vertical arm.
27. DO NOT use sharp items to scratch the grill plate and grill pan.
28. After the heating element is turned off, the fan will continue to run for 5 minutes to dissipate heat. DO NOT cut off the power or unplug this product until the fan stops completely.

Product Structure

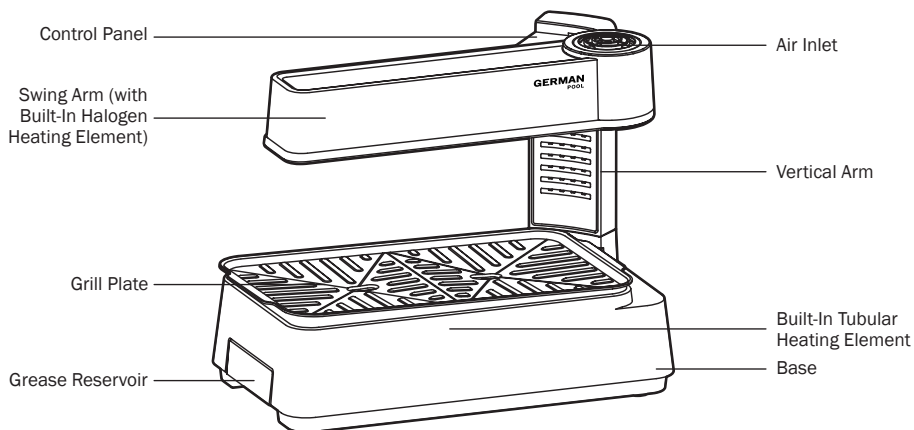

Operation Instructions

Control Panel



Control Keys		LED Display	
	HEATING key		Top Heating Indicator Light
	TIMER key		Bottom Heating Indicator Light
	START/STOP key		Timer Display & Timer Indicator Light

1. Place the main unit on a level surface, and place clean grill plate or grill pan onto the main unit.

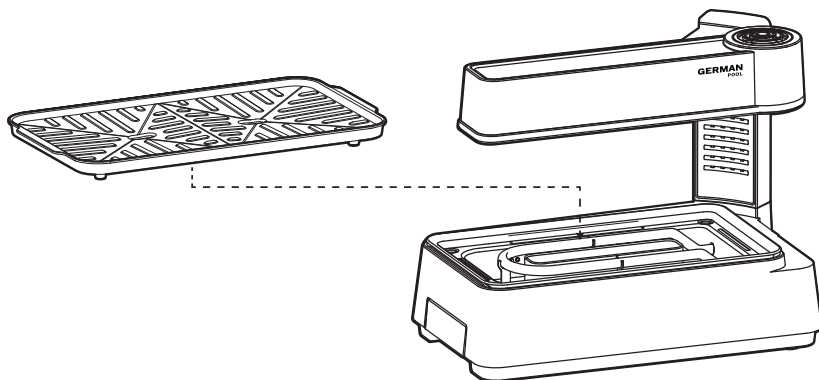



2. Plug the product into a fixed socket. Make sure your household power supply matches the rating label of this product.

Operation Instructions

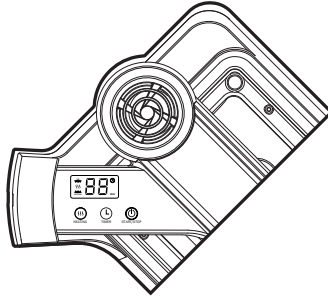
3. Tap HEATING key  to select heating mode; tap 1 time for “Top+Bottom” heating, tap 2 times for “Top” heating only, and tap 3 times for “Bottom” heating only. Tap 4 times and product will cycle back to “Top+ Bottom” heating, and so forth. Heat mode can be adjusted anytime during cooking.



4. After selecting the heat mode, tap START/STOP key  to begin cooking.
5. During cooking, tap TIMER key  to set cooking duration. By default, timer is set to 20 minutes. User may adjust timer duration from 1-60 minutes; each short tap increases timer by 1 minute, tap and hold key to speed up the process.
6. After cooking, tap START/STOP key  to stop heating. Alternatively, the product will automatically stop heating when the timer countdowns to 0 minute.

Swing Arm

1. To add, retrieve or flip over food items, pivot the swing arm away from the pan.
2. When the swing arm is moved to the side, the upper heating element (halogen) will automatically stop heating, lower heating element continues to heat; when moved back to the centre, it will resume heating.

WARNING!

- DO NOT let children operate this product.
- After operation, the grill plate and grill pan will still be hot, DO NOT touch in order to avoid getting burnt.
- Wait until this product has completely cooled down before cutting off its power supply.

Note:

- For better results, let the product preheat for 2 minutes before placing food on the grill plate or grill pan.
- After the heating element is turned off, the product will enter standby state, and the fan will continue to run for approx. 5 minutes to dissipate residual heat.

Care & Maintenance

WARNING!

- Before cleaning and maintenance, make sure the product is cooled down completely and unplugged from the power source.
 - DO NOT immerse or rinse the main body with water.
1. Remove the grill plate and grill pan from the main body and rinse with warm water. DO NOT use abrasive materials to clean the grill plate and grill pan to avoid damaging the non-stick coating.
 2. Pull out the grease reservoir from the bottom of the main body, tip away the grease and wash clean.
 3. If the surface of the main body is dirty, wipe with a warm moist cloth, then dry off with dry cloth. DO NOT use abrasive material to clean the main body to avoid scratching its surface, and DO NOT wash directly with water.
 4. Use warm soft cloth to wipe the body, grill plate and grill pan. For stubborn stains, wipe with cloth moistened with neutral detergent, then wipe the stain off with soft warm cloth.
 5. Regularly clean the product to avoid malfunction.
 6. Use cotton swabs to clean off dirt accumulated on the air inlet and outlet grilles; to remove grease, use toothbrush moistened with non-abrasive cleanser to gently clean off any accumulated grease.
 7. When the product is not in use, store it in a dry and ventilated place away from sunlight.

Technical Specification

Model No.	KQB-39E
Power	900W
Voltage / Frequency	220-240V / 50Hz
Temperature Range	150 °C / 250 °C
Timer Range	1-60 minutes
Product Dimensions	(H) 262 (W) 330 (D) 215 mm
Net Weight	2.27kg

Specification is subject to change without prior notice.

If there is any inconsistency or ambiguity between the English version and the Chinese version, the Chinese version shall prevail.

Refer to www.germanpool.com for the most updated version of the Operating Instructions.

目錄

警告及注意事項 10

產品結構 11

操作說明 12

清潔與保養 14

技術規格 14

保用條款 15

警告及注意事項

⚠ 警告！

使用本產品前，請仔細閱讀所有說明。

- 本產品只限家居室內日常使用，如產品作任何商業、工業、出租或其他用途，保用證即告失效。
- 請勿讓兒童或身體有殘障、精神不健全及對本產品缺乏經驗或知識的人士單獨使用本產品；如需使用，必須要在負責任的成年人監管下方可使用。
- 應照顧好兒童，確保他們不會玩耍本產品。
- 無成年人監管下，勿讓兒童清潔及維護本產品。
- 使用前，請先檢查所有電壓是否與本產品標籤上的電壓相符。
- 如果電源線損壞，為免發生意外，電源線必須由廠方、廠方指定的維修中心或同等合格的技術人員進行更換。
- 清潔或檢查本產品前，必須先關機及拔掉插頭。
- 請聯繫德國寶授權的技術人員進行維修或保養本產品。

1. 本產品只供室內使用。
2. 使用本產品時，必須平穩放在工作台上，嚴禁傾斜。
3. 使用本產品時，產品至少離牆面50厘米以上。
4. 使用本產品時，所用的電源插座必須是3孔、有可靠接地線的安全插座。嚴禁與其他電器共用插座。
5. 使用本產品時，必須遠離易燃易爆物品。
6. 使用本產品時，必須注意產品灼熱的表面，以防燙傷。
7. 在使用本產品的過程中必須由專人看管，嚴禁離開。
8. 嚴禁讓兒童或智力障礙人士使用或操作本產品。
9. 不使用或清潔本產品前必須拔掉電源插頭線。
10. 嚴禁自行修理本產品的任何部份，必須由專業的技術人員修理。
11. 如果本產品電源線損壞，必須停止使用，更換本產品專用的電源線後方可使用。
12. 嚴禁向本產品灑水或將本產品浸入水中。
13. 長時間不使用本產品時，必須把電源開關切換到關閉狀態。
14. 本產品嚴禁在外接定時器或獨立的遙控器遙控控制系統的方式下運行。
15. 本產品不得使用木炭或類似燃料。
16. 如放在不受熱的桌上使用，必須在本產品下放置隔熱墊才使用。
17. 烹調加熱時，切勿碰觸本產品，以免燙傷；請勿讓小孩靠近。
18. 嚴禁使用鋁箔或保鮮膜，因為上部紅外線燈的熱量有可能導致鋁箔或保鮮膜着火引發火災。
19. 烹調多種混合料理時（海鮮類的水分和肉類的油脂等），有可能彈油，有可能成為人體或設備的損傷或火災的原因。請勿在高溫中持續烹飪。
20. 在沒有食材的狀態下，請勿加熱溫度到所需溫度以上，否則有可能成為變色、變形等故障及火災的原因。
21. 嚴禁堵塞本產品的排熱口。
22. 發熱部位周邊為高溫，有燙傷的危險；要格外小心。

警告及注意事項

23. 請勿長時間盯着光波加熱器（紅外線燈），否則有可能發生暫時的眩目現象和眼睛的眩暈等。
24. 使用中或使用後的短時間內，周邊和底面為高溫，請不要放置受熱變形或引火的物品，否則具有發生火災的危險。
25. 使用時，如需翻動、添加或提取食材，利用手把將活動光波加熱器向左或右移動。
26. 使用時，柱子處於高溫狀態，嚴禁觸碰柱子。
27. 嚴禁使用尖銳物件刮烤盤。
28. 停止加熱後，散熱風扇尚會運行約5分鐘。待散熱風扇完全停止運作，方可關閉電源及拔出電源插頭。



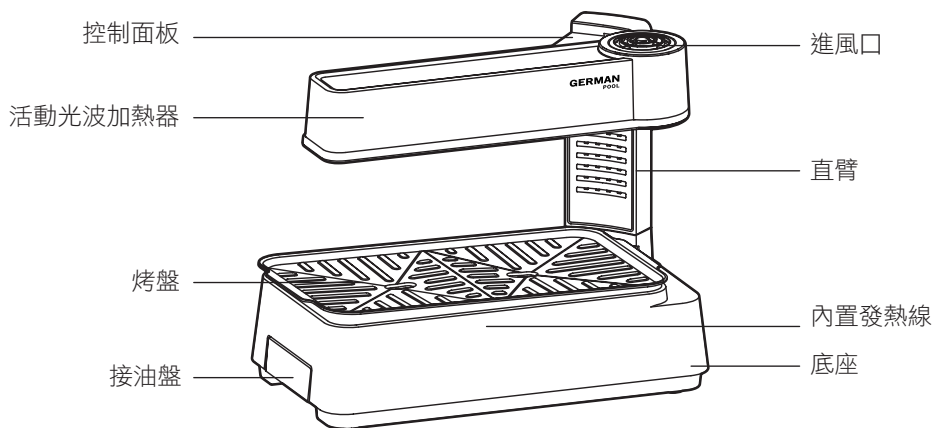



產品結構



操作說明

控制面板



控制按鍵		LED顯示屏	
 HEATING	加熱鍵	 TOP	上加熱指示燈
 TIMER	定時鍵	 BOTTOM	下加熱指示燈
 START/STOP	開始/停止鍵	 88 [°] MIN	定時時間及指示燈

1. 把主機放在水平的桌面上，將清潔乾淨的導油烤盤或平底烤盤放在主機底座上。

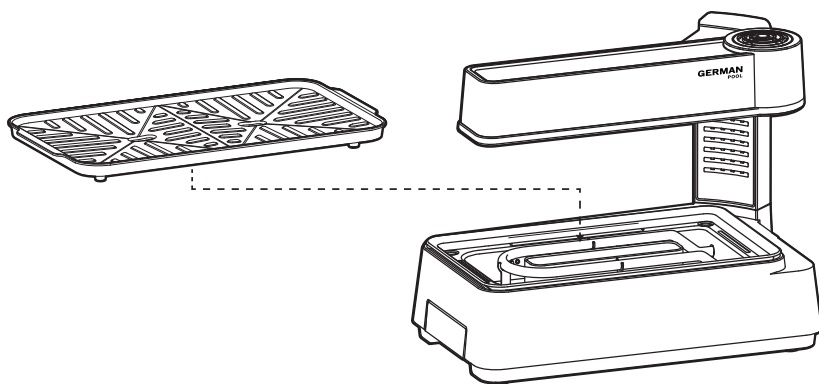



2. 把電源插頭插入固定電源插座內，注意插座的電壓與本產品要求的電壓一致。

操作說明

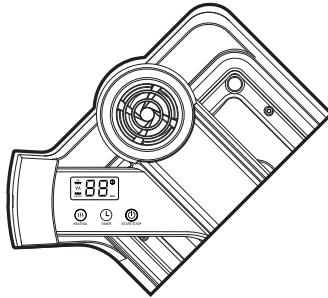
- 按「加熱鍵」，可以選擇加熱模式；檔位順序循環為：上下加熱（光波加熱+發熱管加熱）、上加熱（光波加熱）、下加熱（發熱管加熱），過程中可根據需要隨時調整加熱模式。



- 設置完成後，按「啟動/停止鍵」 開始加熱。
- 烹調過程中，可按「定時鍵」 設置烹調時間，默認為20分鐘，最長為60分鐘，每按一下以1分鐘遞增，長按此鍵可快速遞增。
- 烹調完成後，按「啟動/停止鍵」 停止加熱，或時間倒數至0分鐘後產品自動停止加熱。

撥開加熱器

- 如需翻動、添加或提取食材，可將活動光波加熱器撥開。
- 撥開加熱器時，光波管（上方加熱器）自動停止加熱，下加熱功能不受影響；復位時，自動繼續加熱。

⚠ 警告！

- 嚴禁讓小孩操作本產品。
- 產品使用後，烤盤表面尚有餘熱，嚴禁用手觸摸以防燙傷。
- 必須待本機完全冷卻後方可關閉總電源。

注意：

- 建議先讓產品預熱2分鐘後，再把食物放上烤盤烹調。
- 停止加熱後本產品會進入待機狀態，爐頭風機繼續運行約5分鐘散熱。

清潔與保養

⚠ 警告！

- 清潔及保養本產品前，必須讓產品徹底冷卻並拔出電源插頭。
 - 嚴禁將主機浸入水中或直接沖洗。
1. 將烤盤從主機上取出，用溫水清潔，嚴禁使用研磨性材料，以免損壞表面不黏塗層。
 2. 將底座下方的接油盤取出，倒掉盒內的油並將其清潔乾淨。
 3. 如機身表面髒污，請用溫布擦拭，再用抹布擦拭。嚴禁用研磨性材料以免損壞產品表面，嚴禁直接用水清洗。
 4. 以柔軟的溫布擦拭機身和烤盤，不易擦拭之油污，可用中性清潔劑擦拭後，再以柔軟的溫布擦拭殘渣。
 5. 必須經常保持產品清潔，以免導致產品失靈。
 6. 吸氣及排氣孔表面可用棉花棒將塵埃除去，如有油污，可用牙刷加少許不損器具的清潔劑小心清除。
 7. 產品不用時請放置於通風陰涼乾燥處。

技術規格

型號	KQB-39E
功率	900W
電壓 / 頻率	220-240V / 50Hz
溫度控制範圍	150°C / 250°C
時間控制範圍	1-60分鐘
機身尺寸	(H) 262 (W) 330 (D) 215 mm
淨重	2.27kg

產品規格及設計如有變更，恕不另行通知。
中英文版本如有出入，一概以中文版為準。
本產品使用說明書以 www.germanpool.com 網上版為最新版本。

保用條款

此保用提供德國寶產品之機件在正常使用下壹年保用(自購買日起計算)。

Warranty Terms & Conditions

Under normal operations, the product will guarantee a 1-year full warranty provided by German Pool (effective from the date of purchase).

* 貴戶須在購機十天內，以下列其中一種方式向本公司登記資料，保用手續方正式生效：

- 1) 填妥德國寶VIP手機應用程式保用登記表 (掃描右方二維碼)
- 2) 填妥本公司網頁保用登記表
www.germanpool.com/warranty
- 3) 填妥保用卡郵寄至本公司。



* This warranty is not valid until customer registration information is received by our Service Centre within 10 days of purchase via one of the following means:

- 1) Visit our VIP App and register online:
(Scan the QR Code on the left)
- 2) Visit our website and register online:
www.germanpool.com/warranty
- 3) Complete the attached Warranty Card and mail it back to our Customer Service Centre.



另請填妥以下表格並與正本發票一併保存，以便維修時核對資料。用戶提供之所有資料必須正確無誤，否則免費保用將會無效。 Please fill out the form below. This information and the original purchase invoice will be required for any repairs. Warranty will be invalidated if information provided is found to be inaccurate.

型號 Model No. : KQB-39E

機身號碼 Serial No. : _____ 發票號碼 Invoice No. : _____

購買商號 Purchased From : _____ 購買日期 Purchase Date : _____

1. 未能出示購買發票正本者，將不獲免費維修服務。
2. 用戶應依照說明書的指示操作。本保用並不包括：
 - 上門安裝、檢驗、維修或更換零件之人工以及一切運輸費用；
 - 因天然與人為意外造成的損壞 (包括運輸及其他)；
 - 電源接合不當、不依說明書而錯誤或疏忽使用本機所引致之損壞。
3. 於下列情況下，用戶之保用資格將被取消：
 - 購買發票有任何非認可之刪改；
 - 產品被用作商業或工業用途；
 - 產品經非認可之技術人員改裝或加裝任何配件；
 - 機身編號被擅自塗改、破壞或刪除。
4. 總代理有權選擇維修或更換配件或其損壞部份。
5. 產品一經被轉讓，其保用即被視作無效。

1. Customer who fails to present original purchase invoice will not be eligible for free warranty service.
2. Customer should always follow the operating instructions. This warranty does not apply to:
 - labour costs for on-site installation, check-up, repair, replacement of parts and other transportation costs;
 - damages caused by accidents of any kind (including material transfer and others);
 - operating failures resulting from applying incorrect voltage, improper usage, and unauthorized installations or repairs.
3. This warranty is invalid if:
 - the purchase invoice is modified by an unauthorized party;
 - the product is used for any commercial or industrial purposes;
 - the product is repaired or modified by unauthorized personnel, or unauthorized parts are installed;
 - the serial number is modified, damaged or removed from the product.
4. German Pool will, at its discretion, repair or replace any defective part.
5. This warranty will be void if there is any transfer of ownership from the original purchaser.

客戶服務及維修中心

中國香港

九龍大業街59號

三湘九龍灣貨運中心地下B室

電話：+852 2333 6249

傳真：+852 2356 9798

電郵：repairs@germanpool.com

中國澳門

澳門青洲大馬路(青洲新路)

515號美居廣場第二期1樓A座

電話：+853 2875 2699

傳真：+853 2875 2661

Customer Service & Repair Centre

Hong Kong, China

Unit B, G/F, Sunshine Kowloon Bay

Cargo Centre, 59 Tai Yip Street, Kowloon

Kowloon, Hong Kong

Tel : +852 2333 6249

Fax : +852 2356 9798

Email : repairs@germanpool.com

Macau, China

A, 1 Andar, Mei Kui Kuong Cheong Fase 2,

No.515 Avenida Do Conselheiro Borja

Macau

Tel : +853 2875 2699

Fax : +853 2875 2661

此保用只適用於香港及澳門

This warranty is valid only in Hong Kong and Macau

German Pool (Hong Kong) Limited

Hong Kong, China

Room 113, Newport Centre Phase II, 116 Ma Tau
Kok Road, Tokwawan, Kowloon, Hong Kong.
Tel: +852 2773 2888
Fax: +852 2765 8215

Mainland China

8th, Xinxiang Road, Wusha Industrial Park,
Daliang, Shunde, Foshan, Guangdong
Tel: +86 757 2219 6888
Fax: +86 757 2219 6809

Macau, China

A, 1 Andar, Mei Kui Kuong Cheong Fase 2,
No.515 Avenida Do Conselheiro Borja, Macau
Tel: +853 2875 2699
Fax: +853 2875 2661



香港《S MARK》
安全認證



中國櫥櫃/家電行業
十大影響力品牌



CEO非凡品牌大賞



香港優質商標



香港工商業獎



2007
最具潛質
創星品牌企業獎



香港中小企業
最佳品牌大獎



香港消費者推祟品牌



香港《心博》
優質服務證書



香港名牌十年成就獎
HONG KONG TOP BRAND TEN YEAR
ACHIEVEMENT AWARD

© All rights reserved. Copying, reproducing or using the contents of this manual is not allowed without prior authorization from German Pool, violators will be prosecuted.