

Foldable Travel Kettle

KTT-309



Online Warranty Registration



Please read these instructions and warranty information carefully before use and keep them handy for future reference.

USER MANUAL

請即進行保用登記！
有關保用條款細則，請看說明書最後一頁。

Please register your warranty information now !
For Warranty Terms & Conditions,
please refer to the last page of this user manual.

Table of Contents

Warnings & Safety Precautions 04

Product Structure 06

Operation Instructions 07

Cleaning & Maintenance 09

Troubleshooting 10

Technical Specification 11

Warranty Terms & Conditions 19

Warnings & Safety Precautions

WARNING!

Read all instructions carefully before using this product.

- This product is for domestic indoor use only. If this product is used for any commercial, industrial, rental or other purposes, product warranty will be VOIDED.
 - This product is not intended for use by children or persons with reduced physical, sensory or mental capabilities, or lack of experience and knowledge, unless they have been given supervision or instruction concerning use of this product by an adult responsible for their safety.
 - Mind your children and DO NOT let children play with this product.
 - Cleaning and user maintenance shall not be made by children without supervision.
 - Check the voltage indicated on the rating label before using this product.
 - If the supply cord is damaged, it must be replaced by the manufacturer, its service agent or similarly qualified persons in order to avoid hazards.
 - Unplug this product from the power source before cleaning and maintenance.
 - Contact German Pool authorized service technician for repair or maintenance of this product.
-
1. Make sure the plug is completely plugged into the socket before use, in order to avoid causing electric shock, or causing the plug to overheat leading to open circuit, short circuit, smoke and fire.
 2. DO NOT plug or unplug product with wet hands to avoid causing electric shock.
 3. To avoid scalding, DO NOT touch the spout when this product is in use.
 4. Use with socket with rated voltage of 100-240V. DO NOT share socket with other appliances, as it may lead to overheating and fire hazard.
 5. DO NOT allow children or persons with physical or sensory disabilities, mental illness or those who lack experience and knowledge to operate this product without supervision, in order to avoid scalding, electric shock or personal injury.
 6. DO NOT insert metal or other foreign object into the heat vent or gaps, in order to avoid electric shock or malfunction that may lead to personal injury.
 7. DO NOT splash water on this product to avoid causing short circuit or electric shock.
 8. The pot is made of silicone; when using this product, DO NOT pierce the silicone with sharp object in order to avoid damaging the silicone.
 9. DO NOT damage the power cord or plug to avoid causing short circuit or fire. If the power cord is damaged, to avoid danger, it must be replaced by the manufacturer's repair department or a qualified professional technician from a similar department.
 10. DO NOT attempt to retrofit, dismantle or repair this product by yourself, as it may cause fire hazard, electric shock or personal injury.
 11. Regularly remove dust and dirt on this product's plug and socket. Accumulation of dust will cause the plug to become humid and lead to poor insulation, in turn causing a fire hazard. Regularly unplug the product and use dry cloth to wipe off dust on both ends of the power cable.
 12. This product must be used with a single-phase grounded polarized power with reliable grounding! If grounding device is not installed, it may cause induced static electricity on metal parts of this product, and lead to danger of electric shock in the event of a malfunction or power leakage.

Warnings & Safety Precautions

13. The heating element will become hot during use. DO NOT touch in order to avoid getting burnt. Touching the hot element may lead to scalding.
14. This product is for domestic use only, DO NOT use for commercial purposes.
15. DO NOT put this product in water or use in humid environments, and DO NOT place this product near other heat sources.
16. When unplugging from the socket, grip and pull by the plug, DO NOT pull on the power cord to avoid damaging the cord and causing an open circuit.
17. DO NOT use this product on an unstable surface or on a pad that is not heat-resistant, as it may cause the kettle to tilt, leading to injuries or fire and other accidents.
18. DO NOT use this product near walls or furniture, as the steam may cause furniture and wall to discolor or deform. Please place this product at least 30 cm away from walls and furniture.
19. DO NOT clean this product before it has completely cooled down. Touching the hot surfaces may lead to scalding.
20. DO NOT let this product boil empty. Frequent dry-boiling will shorten the lifespan of this product.

Product Structure

Main Body

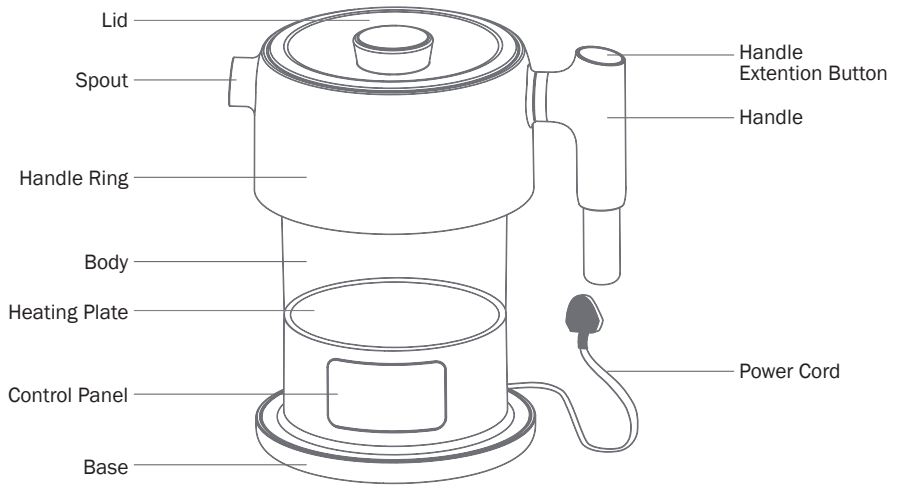

Extendable Handle

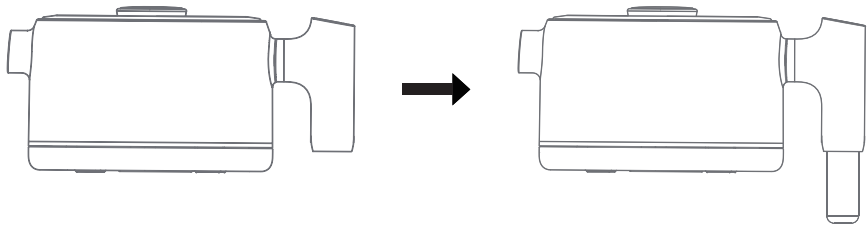

Press the Handle Extension Button to extend the handle for easy gripping.

Operation Instructions

Control Panel

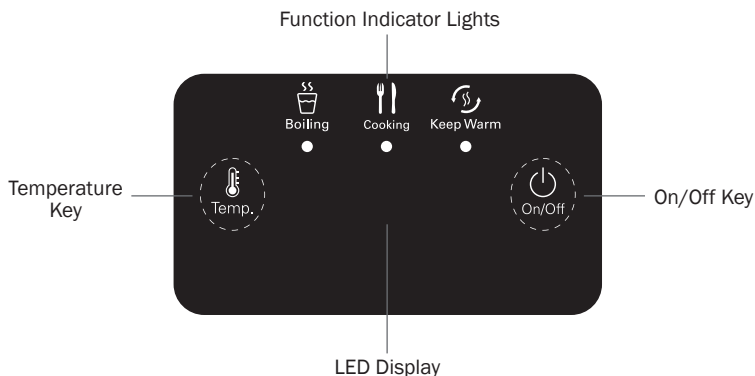

⚠ WARNING!

- When pouring water into the pot, DO NOT exceed the 600 ml water mark (including food ingredients).
- Make sure the product is placed on a flat and level surface, make sure there are no foreign objects under the product base as that may cause the product to tilt and spill during use.

Folding & Unfolding The Kettle







- Unfolding the kettle: Hold the kettle base with one hand, and grip the handle ring with the other. Gently pull the kettle base downwards to fully open the kettle. Take the handle out from the bottom of the base, place onto the handle knob and lock it into position.
- Folding the kettle: Place kettle on a flat and level surface. Gently push the top of the kettle downwards until it is completely folded up. Unlock the handle and place it back under the base.

Using For The First Time





1. Before using the kettle for the first time, make sure to remove all packing materials.
2. Unfold the kettle completely, and wash the inside of the kettle, the spout and the lid with a non-abrasive sponge and diluted neutral detergent. Take care not to wet the product base and the power cord interface on the back of the base.
3. Use a damp soft cloth to wipe the base and the outside of the kettle, and dry off with a dry cloth. Allow the kettle and all parts to air dry completely before use.
4. Add water to the 600ml maximum water mark, boil and pour off the water twice (do not drink).

Operation Instructions

How To Use

1. Connect to the power source, tap On/Off key , buzzer beeps once and product enters standby state.
2. In standby state, tap On/Off key  to cycle among Boiling  / Cooking  / Keep Warm  functions, the corresponding indicator light lights up.
3. After selecting desired function, if product does not receive any further command in 6 seconds, it will automatically start heating.
4. If user wishes to cancel the function during operation, tap On/Off key  and the product will stop heating and return to standby state.
5. When heating is completed, buzzer will beep three times, and product will automatically return to standby state.
6. After heating is completed, first pull the plug out of the socket, then pull the power cord off the kettle before lifting the kettle.
7. To prevent the lid falling off when pouring out water, either keep a hand on the lid or take off the lid.

Keep Warm Function

1. In standby state, tap On/Off key  3 times to select Keep Warm  function. Keep Warm indicator light  lights up, LED display shows default keep warm temperature of 50°C.
2. Tap Temperature key  to cycle keep warm temperature between 40-90°C; each tap increases temperature by 10°C.
3. After selecting desired temperature, if product does not receive any further command in 6 seconds, it will automatically start to keep warm. LED display shows current water temperature.
4. If water temperature is lower than the selected temperature, product will automatically start heating up until it reaches the selected temperature; if water temperature is already higher than the selected temperature, product will only start heating after the water temperature has dropped to below the selected temperature.
5. Any time during Keep Warm process, user may tap Temperature key  to adjust the water temperature.

Note:

- DO NOT use unboiled water for Keep Warm function, as Keep Warm function will not heat water to boiling point.
- Keep Warm function can operate up to a maximum of 6 hours. Please stop the function manually according to your personal needs.
- After keeping warm for 6 hours, the kettle will automatically stop operating and return to standby state.
- Water can be kept warm at different temperatures for different drinks (recommended: 70°C for baby milk powder, 90°C for green tea).

Cleaning & Maintenance

WARNING!

- Unplug from the power source and wait until the kettle has completely cooled down before commencing cleaning and maintenance.
- DO NOT immerse product in water, and DO NOT use benzene, gasoline, alcohol, cleansing powder or hard scrubber to clean this product.

Kettle Lid

1. Please keep a light hand when putting on the lid or placing the lid down on a surface.
2. It is recommended to rinse the lid with water after each use.

Heating Plate Inside The Kettle

1. The heating plate can be washed with diluted detergent, wiped with soft cloth or gently scrubbed with toothbrush.
2. Food debris on the heating plate should be cleaned off promptly after each use, otherwise it may stick to the plate and become hard to clean off.
3. After heating, discoloration or spots may appear on the surface of the metal parts, this is normal and does not affect the use of the product.
4. After cleaning, dry off the kettle interior and heating plate with a dry cloth.

Kettle Base & Handle Ring

1. Use a wrung out cloth to wipe the plastic parts and the exterior of the kettle.
2. DO NOT immerse the product in water.
3. After cleaning, make sure the kettle surface, power cord and power plug are completely dry before using.

Storage

1. Please clean the kettle thoroughly and wait until the inside and outside of the kettle are completely dry before folding.
2. Wrap the folded up kettle in its dustproof bag for storage.

Troubleshooting

Problem	Possible Cause	Solution
Water pooled around the product base	Water is leaking from the spout	If water is spilling from the spout, it may be due to overfilling. DO NOT fill to above the maximum water mark
	Kettle is not properly sealed	Contact German Pool Customer Service & Repair Centre
Product does not respond or heat up when key is tapped	Control circuit malfunction	Contact German Pool Customer Service & Repair Centre
Product never reached boiling point through the whole heating process	This may happen if product is used in high altitudes	This is a normal phenomenon
	Temperature sensor malfunction	Contact German Pool Customer Service & Repair Centre
Control panel doesn't light up and buzzer doesn't beep even though product is connected to the power source	Circuit malfunction	Contact German Pool Customer Service & Repair Centre
Leakage switch trips when product is connected to the power source	Circuit malfunction	Contact German Pool Customer Service & Repair Centre
Control panel shows "E1"	Sensor open circuit	Contact German Pool Customer Service & Repair Centre
Control panel shows "E2" or "E3"	Dry boil or sensor open circuit	Turn off product, wait till product cools down then retry. If problem persists, contact German Pool Customer Service & Repair Centre

Technical Specification

Model	KTT-309
Voltage	100 - 240 V~
Frequency	50 / 60 Hz
Power	245 - 850 W
Capacity	600 ml
Product Dimensions (Folded) (Unfolded)	(H) 90 (W) 145 (D) 125 mm (H) 190 (W) 180 (D) 125 mm
Net weight	0.8 kg

- Specification is subject to change without prior notice.
- If there is any inconsistency or ambiguity between the English version and the Chinese version, the Chinese version shall prevail.
- Refer to www.germanpool.com for the most updated version of the User Manual.

目錄

警告及注意事項 13

產品結構 14

使用說明 15

清潔與保養 17

故障檢修 18

技術規格 18

保用條款 19

警告及注意事項

⚠ 警告！

使用本產品前，請仔細閱讀所有說明。

- 本產品只限家居室內日常使用，如產品作任何商業、工業、出租或其他用途，保用證即告失效。
- 請勿讓兒童或身體有殘障、精神不健全及對本產品缺乏經驗或知識的人士單獨使用本產品；如需使用，必須要在負責任的成年人監管下方可使用。
- 應照顧好兒童，確保他們不會玩耍本產品。
- 無成年人監管下，勿讓兒童清潔及維護本產品。
- 使用前，請先檢查所有電壓是否與本產品標籤上的電壓相符。
- 如果電源線損壞，為免發生意外，電源線必須由廠方、廠方指定的維修中心或同等合格的技術人員進行更換。
- 清潔或檢查本產品前，必須先關機及拔掉插頭。
- 請聯繫德國寶授權的技術人員進行維修或保養本產品。

1. 必須將電源插頭切實插到底。避免觸電和插頭過熱而導致斷路、短路、冒煙、著火。
2. 嚴禁濕手拔、插電源插頭，防止觸電。
3. 使用中嚴禁觸摸壺嘴，以免燙傷。
4. 單獨使用額定電額100-240V的插座。若與其他電器並用，可能會因發熱而引起火災。
5. 嚴禁由兒童、殘疾人、感官或精神病患者和缺乏經驗和文化的人單獨使用，以免發生燙傷、觸電等受傷事故。
6. 嚴禁以金屬等異物插入散熱孔或間隙中，否則可能導致觸電和異常而造成傷害。
7. 嚴禁向本產品淋水，有短路、觸電的危險。
8. 壺身是硅膠製品，在使用時嚴禁接觸尖刺和鋒利的物品，避免損壞硅膠。
9. 嚴禁損壞電源線或電源插頭。避免短路、著火。如電源線損壞，為避免危險，必須由製造商、其維修部或類似部門的專業人員更換。
10. 嚴禁試圖自行改裝、分解或修理本產品，可能會引起火災、觸電或傷害事故。
11. 定期除去本體插頭、電源插頭上的灰塵等。如灰塵積聚過多，則會因受潮等導致絕緣不良，可能引起火災事故。拔下本體插頭、電源插頭並用乾布擦掉插頭上的灰塵。
12. 本機應使用單相兩極帶接地的電源插座，並保證其可靠接地！未安裝接地裝置，可能會引起本體等其他金屬部件帶有感應靜電。當發生故障或漏電時有觸電危險。
13. 發熱盤高溫嚴禁觸摸，以免燙傷，如果碰到高溫部份則可能會引起燙傷事故。
14. 本產品只適用於家庭使用，嚴禁用於商業用途。
15. 嚴禁將產品放入水中或高濕環境中，嚴禁靠近其他熱源。
16. 拔電源插頭時，必須手持插頭部份，嚴禁拉扯電源線，避免電線損壞而斷路。
17. 嚴禁在不穩定的台面上或不能受熱的墊子上使用。可能會因為壺的傾倒而引起傷害或火災等事故。
18. 嚴禁在靠近牆及家具處使用，蒸氣會導致家具和牆壁變色、變形。請離牆和家具30厘米以上。
19. 必須在本產品充分冷卻後再進行清洗。如果碰到高溫部份則可能會引起燙傷事故。
20. 嚴禁讓本產品乾燒，若經常乾燒會影響本產品使用壽命。

產品結構

主機

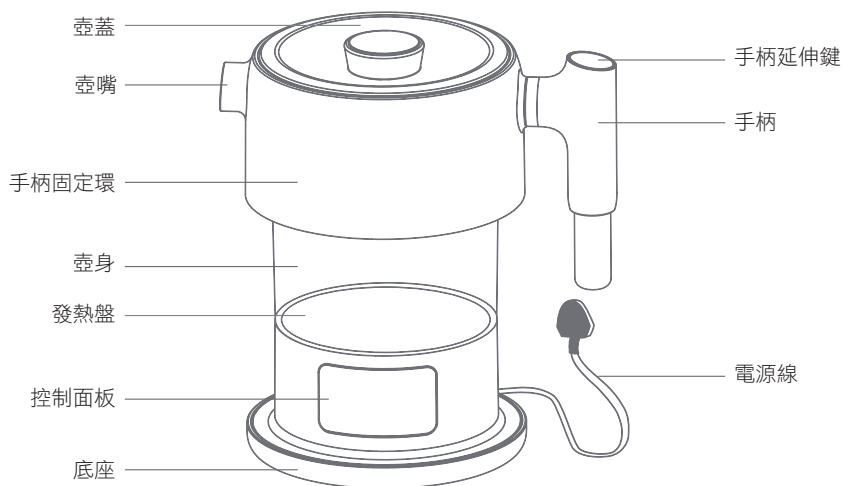

伸縮手柄

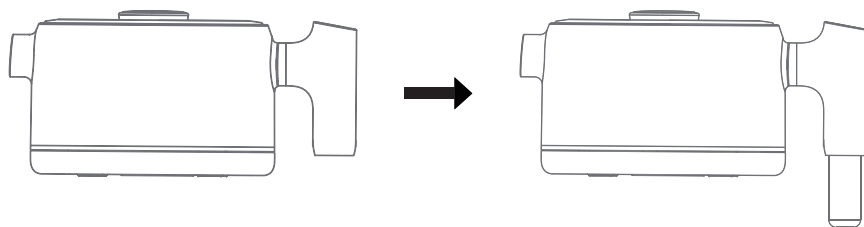

按手柄延伸鍵可伸出手柄，方便拿取及使用。

使用說明

控制面板



⚠ 警告！

- 往壺身注水時，必須注意水量不得超過600毫升（包括已放食材）。
- 必須將壺身正確放置於平整的桌面上，底座下不能有其他物體或異物，否則產品在使用過程中會有傾倒危險。

展開和摺合水壺







- 展開水壺：一手握著水壺底座，一手握著手柄固定環。把水壺底座輕力向下拉出，把水壺完全展開。
- 摺合水壺：把水壺放在平坦的表面上。把水壺從頂部輕力向下壓，直至把壺身壓下，完全摺合起來。

初次使用





1. 初次使用本產品，請確保已移除所有包裝物料。
2. 把水壺完全展開，用少許中性清潔劑和非磨蝕性海綿徹底清洗水壺內部、壺嘴及壺蓋。注意不要弄濕水壺底座和底座背面的電源線接頭。
3. 用微濕軟布擦拭壺身和底座，再用乾布抹乾；把水壺及所有部件完全風乾後，才可開始使用。
4. 加水至600ml最高水位線，煲水一至兩次後倒掉（嚴禁飲用）。

使用說明

使用步驟

1. 接通電源，按「電源鍵 」進入待機狀態，蜂鳴器發出提示聲1聲。
2. 在待機狀態下，按「電源鍵 」循環選擇煲水  / 煮食  / 保溫  功能，相應指示燈常亮。
3. 選擇完成後，如6秒內無任何操作，產品自動進行加熱。
4. 使用期間如需停止操作，可按「電源鍵 」取消當前功能並返回待機狀態。
5. 加熱完成後，蜂鳴器發出提示聲3聲，自動返回待機狀態。
6. 使用完畢後，將電源插頭拔離插座，再把電源線拔離水壺，然後才可提起水壺。
7. 如需倒水，請按住或打開壺蓋，以免壺蓋掉下來。

保溫功能

1. 在待機狀態下，按「電源鍵 」3次選擇保溫  功能，保溫功能指示燈  常亮；顯示屏顯示預設保溫溫度50°C。
2. 按「溫度鍵 」調節保溫溫度，每按一次增加10°C；可自調範圍為40–90°C。
3. 設定好所需溫度後，如6秒內無任何操作，產品自動進行保溫，顯示屏顯示當前水溫。
4. 如水溫低於保溫溫度，產品會自動加熱，直至達到保溫溫度後才停止加熱；如水溫已高於保溫溫度，產品會待水溫下降至低於保溫溫度，才自動加熱。
5. 保溫期間，可按「溫度鍵 」調節保溫溫度。

注意：

- 請勿使用生水進行保溫，因應保溫功能不會把水煲至沸騰。
- 保溫功能最長可運作6小時，請按個人需要手動停止保溫。
- 保溫6小時後，水壺會自動停止保溫及返回待機狀態。
- 可利用保溫功能調至合適水溫，用來沖調不同飲品（建議：70°C 嬰兒沖奶粉；90°C 綠茶）。

清潔與保養

⚠ 警告！

- 清潔及保養前，必須拔除電源插頭，待機身冷卻後再進行清潔。
- 嚴禁將本產品浸入水中清洗，嚴禁使用香蕉水、汽油、酒精、去污粉，或使用硬質刷擦拭。

壺蓋

1. 使用及放置時注意輕放。
2. 建議每次使用後用水清洗。

壺內發熱盤

1. 使用稀釋後的洗潔精，或使用抹布、牙刷擦拭。
2. 發熱盤上的污垢如不及時洗淨，會黏附在發熱盤上難以清洗，每次使用後應及時擦洗乾淨。
3. 金屬部件受熱後，其表面可能會出現變色或斑紋現象，但不影響使用。
4. 洗淨後用乾抹布擦乾壺體內部及發熱盤表面。

底座及手柄固定環

1. 用擰乾的抹布擦拭塑料及壺體表面。
2. 清洗時嚴禁浸入水中。
3. 使用前請確保所清洗的部件表面、電源線和插頭乾燥。

使用後擺放

1. 使用後把整機清潔乾淨，待產品完全風乾後才將壺身摺合。
2. 將摺合後的水壺放於防塵袋內收藏保存。

故障檢修

故障現象	可能原因	排除故障
使用時底座表面有積水	壺嘴漏水	若積水由壺嘴噴出，可能是水位過高，屬操作不當現象
	壺身密封不良	聯絡德國寶客戶服務及維修中心
按鍵後本產品無反應或不加熱	控制電路故障	聯絡德國寶客戶服務及維修中心
從開始到加熱完成一直沒有達到沸騰狀態	可能使用地方為高原地區	此乃正常現象
	溫度傳感器故障	聯絡德國寶客戶服務及維修中心
接通電源後本產品無顯示、無蜂鳴聲	電路故障	聯絡德國寶客戶服務及維修中心
接通電源後漏電開關跳開	電路故障	聯絡德國寶客戶服務及維修中心
控制面板顯示「E1」	傳感器開路	聯絡德國寶客戶服務及維修中心
控制面板顯示「E2」或「E3」	乾燒或傳感器斷路	待壺身冷卻後再操作，如情況無法改善，聯絡德國寶客戶服務及維修中心

技術規格

型號	KTT-309
電壓	100 - 240 V~
頻率	50 - 60 Hz
功率	245 - 850 W
容量	600 ml
產品尺寸 (摺合) (展開)	(H) 90 (W) 145 (D) 125 mm (H) 190 (W) 180 (D) 125 mm
淨重	0.8 kg

- 產品規格及設計如有變更，恕不另行通知。
- 中英文版本如有出入，一概以中文版為準。
- 本產品使用說明書以www.germanpool.com網上版為最新版本。

保用條款

此保用提供德國寶產品之機件在正常使用下壹年保用(自購買日起計算)。

Warranty Terms & Conditions

Under normal operations, the product will guarantee a 1-year warranty provided by German Pool (effective from the date of purchase).

* 貴戶須在購機十天內，以下列其中一種方式向本公司登記資料，保用手續方正式生效：

- 1) 填妥德國寶VIP手機應用程式保用登記表(掃描右方二維碼)
- 2) 填妥本公司網頁保用登記表
www.germanpool.com/warranty
- 3) 填妥保用卡郵寄至本公司。



* This warranty is not valid until customer registration information is received by our Service Centre within 10 days of purchase via one of the following means:

- 1) Visit our VIP App and register online:
(Scan the QR Code on the left)
- 2) Visit our website and register online:
www.germanpool.com/warranty
- 3) Complete the attached Warranty Card and mail it back to our Customer Service Centre.



另請填妥以下表格並與正本發票一併保存，以便維修時核對資料。用戶提供之所有資料必須正確無誤，否則免費保用將會無效。 Please fill out the form below. This information and the original purchase invoice will be required for any repairs. Warranty will be invalidated if information provided is found to be inaccurate.

型號 Model No. : KTT-309

機身號碼 Serial No. : _____ 發票號碼 Invoice No. : _____

購買商號 Purchased From : _____ 購買日期 Purchase Date : _____

1. 未能出示購買發票正本者，將不獲免費維修服務。
2. 用戶應依照說明書的指示操作。本保用並不包括：
 - 上門安裝、檢驗、維修或更換零件之人工以及一切運輸費用；
 - 因天然與人為意外造成的損壞(包括運輸及其他)；
 - 電源接合不當、不依說明書而錯誤或疏忽使用本機所引致之損壞。
3. 於下列情況下，用戶之保用資格將被取消：
 - 購買發票有任何非認可之刪改；
 - 產品被用作商業或工業用途；
 - 產品經非認可之技術人員改裝或加裝任何配件；
 - 機身編號被擅自塗改、破壞或刪除。
4. 總代理有權選擇維修或更換配件或其損壞部份。
5. 產品一經被轉讓，其保用即被視作無效。

1. Customer who fails to present original purchase invoice will not be eligible for free warranty service.
2. Customer should always follow the operating instructions. This warranty does not apply to:
 - labour costs for on-site installation, check-up, repair, replacement of parts and other transportation costs;
 - damages caused by accidents of any kind (including material transfer and others);
 - operating failures resulting from applying incorrect voltage, improper usage, and unauthorized installations or repairs.
3. This warranty is invalid if:
 - the purchase invoice is modified by an unauthorized party;
 - the product is used for any commercial or industrial purposes;
 - the product is repaired or modified by unauthorized personnel, or unauthorized parts are installed;
 - the serial number is modified, damaged or removed from the product.
4. German Pool will, at its discretion, repair or replace any defective part.
5. This warranty will be void if there is any transfer of ownership from the original purchaser.

客戶服務及維修中心

香港

九龍大業街59號

三湘九龍灣貨運中心地下B室

電話：+852 2333 6249

傳真：+852 2356 9798

電郵：repairs@germanpool.com

澳門

澳門青洲大馬路(青洲新路)

515號美居廣場第二期1樓A座

電話：+853 2875 2699

傳真：+853 2875 2661

Customer Service & Repair Centre

Hong Kong

Unit B, G/F, Sunshine Kowloon Bay

Cargo Centre, 59 Tai Yip Street, Kowloon

Kowloon, Hong Kong

Tel : +852 2333 6249

Fax : +852 2356 9798

Macau

A, 1 Andar, Mei Kui Kuong Cheong Fase 2,

No.515 Avenida Do Conselheiro Borja

Macau

Tel : +853 2875 2699

Fax : +853 2875 2661

此保用只適用於香港及澳門

This warranty is valid only in Hong Kong and Macau

German Pool (Hong Kong) Limited

Hong Kong

Room 113, Newport Centre Phase II, 116 Ma Tau
Kok Road, Tokwawan, Kowloon, Hong Kong.
Tel: +852 2773 2888
Fax: +852 2765 8215

China

8th, Xinxiang Road, Wusha Industrial Park,
Daliang, Shunde, Foshan, Guangdong
Tel: +86 757 2219 6888
Fax: +86 757 2219 6809

Macau

A, 1 Andar, Mei Kui Kuong Cheong Fase 2,
No.515 Avenida Do Conselheiro Borja, Macau
Tel: +853 2875 2699
Fax: +853 2875 2661



香港《S MARK》
安全認證



中國標榜/家電行業
十大影響力品牌



CEO非凡品牌大賞



香港優質商標



香港工商業獎



2007
最具潛質
創星品牌企業獎



香港中小企業
最佳拍檔大獎



香港消費者推祟品牌



香港《心嚮》
優質服務證書



香港名牌十年成就獎
HONG KONG TOP BRAND TEN YEAR
ACHIEVEMENT AWARD

© All rights reserved. Copying, reproducing or using the contents of this manual is not allowed without prior authorization from German Pool, violators will be prosecuted.